

#TL100132

INSTALLATION MANUAL

**MS100198**

APR 2.5T Throttle Inlet Pipe



**APR**



VAG AUTOSPORT



Notes:

These instructions were written for a North American specification 8V RS3, but others like the TT-RS are similar.

When disassembling the car, be sure to keep all fasteners so they can be reused. It is recommend that you get some kind of compartmented tray to organize the fasteners, such as a fishing tackle box or several large ice cube trays. Fasteners that are not reused for reinstallation are noted in the instructions. All directions used in this manual (right, left, front, etc.) are based on if you were sitting in the drivers seat of the car.

These instructions assume that you have basic mechanical skills and several varieties of basic hand tools in order to install the kit. If you have any questions about the install, feel free to contact your APR representative.

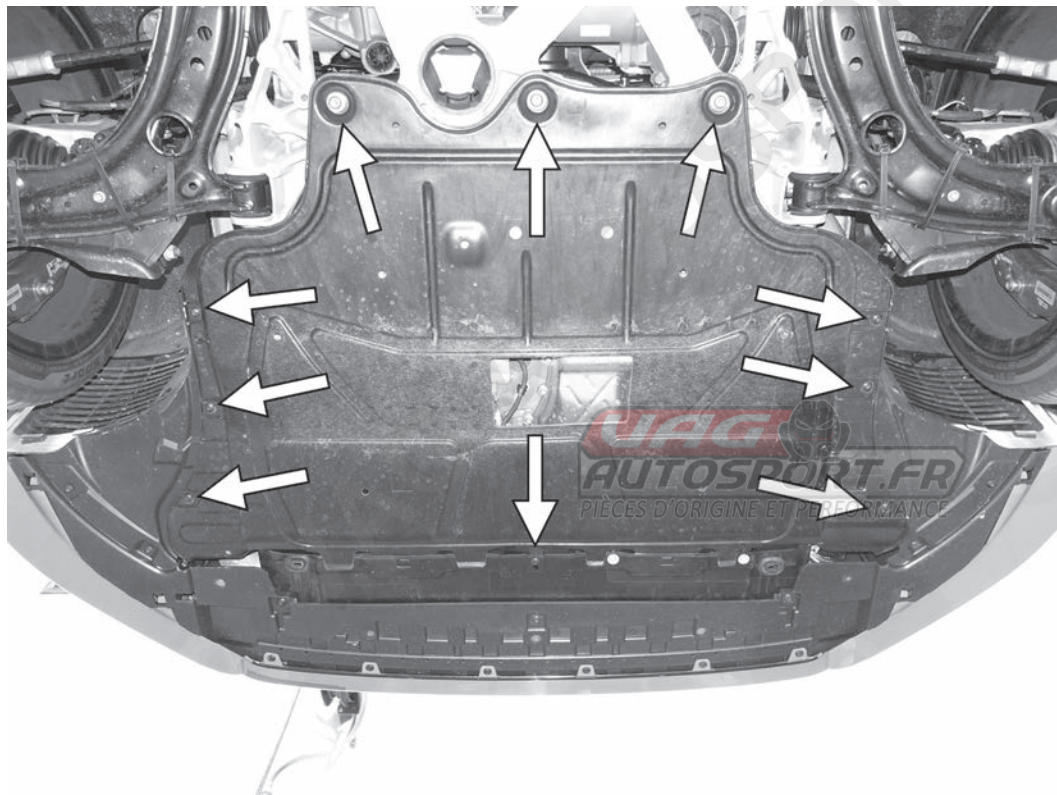

1) Securely raise the vehicle on ramps or a lift. Remove the seven T25 screws on the sides and front of the belly pan. While supporting the belly pan, remove the three T45 screws along the back of the belly pan. Lower the back of the pan and slide the pan backwards, noting how the pan attaches to the bottom of the front bumper cover.

2) Loosen the two 7mm hose clamps, and then remove the inter-cooler outlet hose.

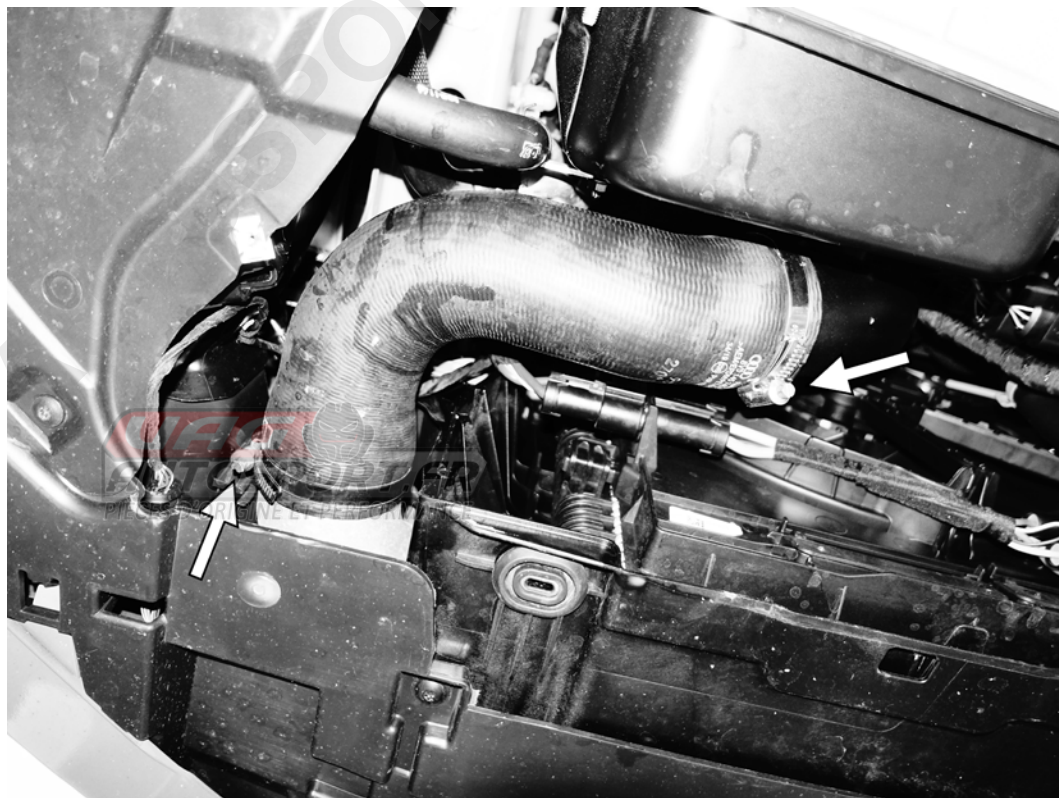

TL100132



3) Remove the engine cover by carefully lifting each of the four corners, popping the cover off the mounting posts.

**APR**

4) Disconnect the four electrical connectors near the throttle body. These include the connectors for both the pre- and post-throttle body MAP sensors, the connector for the throttle body, and the connector for the diverter valve.

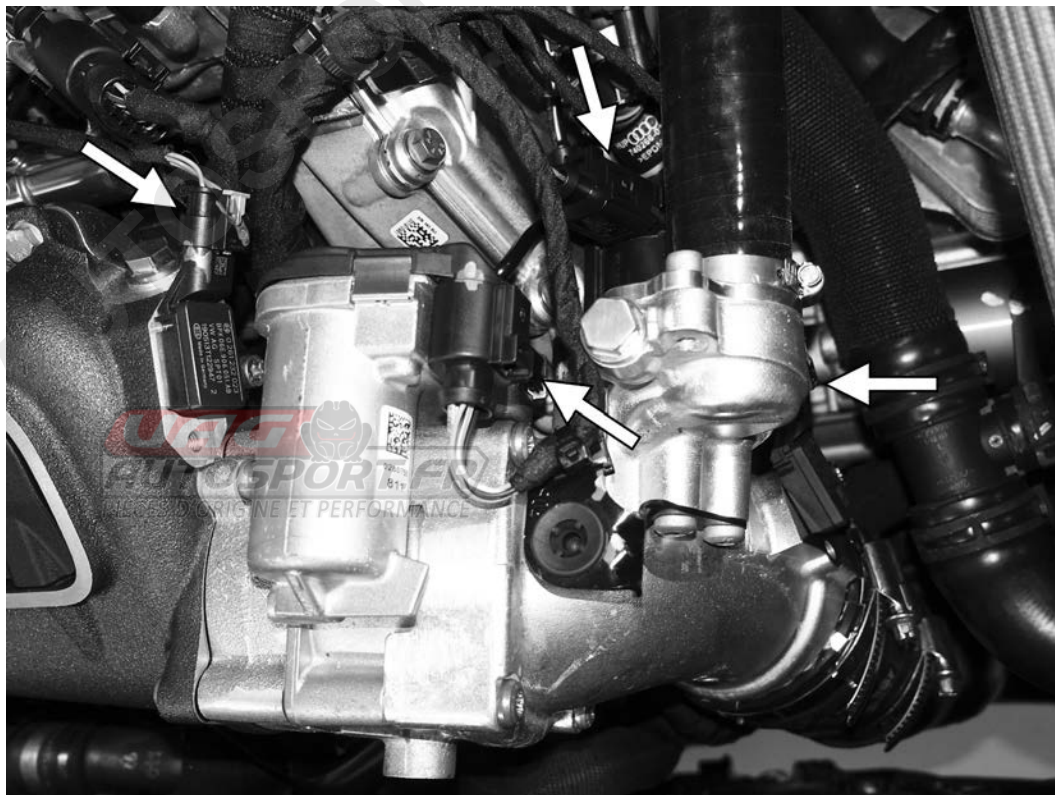

TL100132

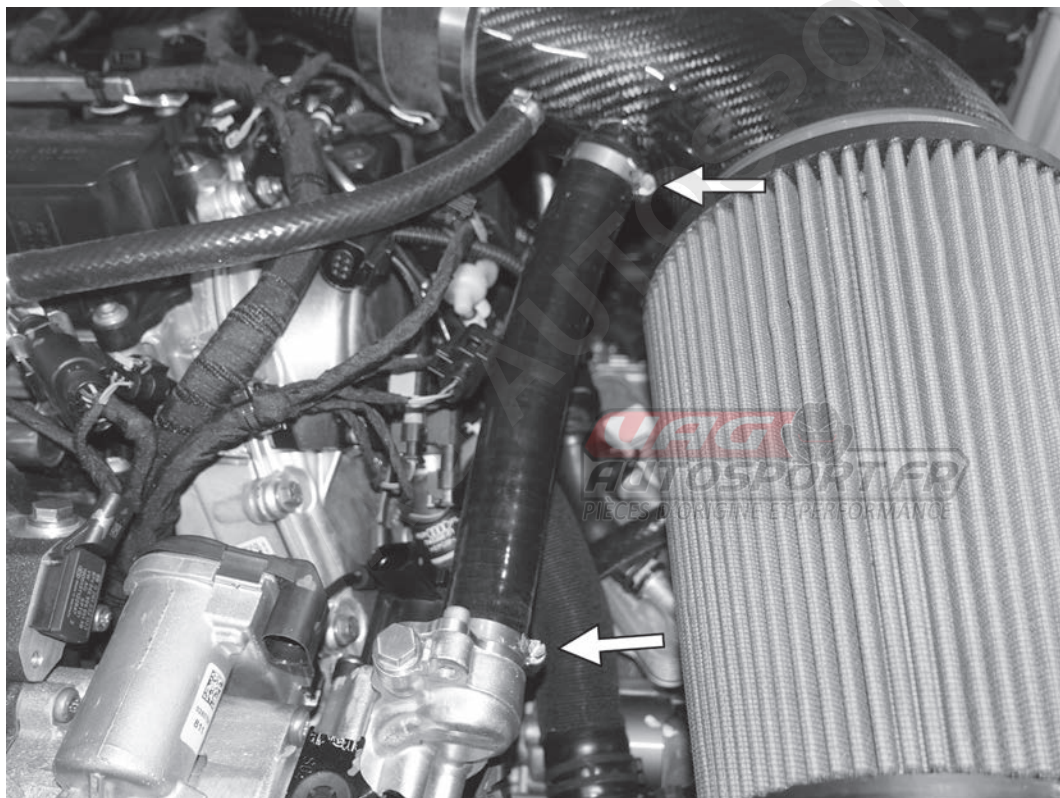

5) If equipped with an APR intake, remove the two clamps on both ends of the hose that connects the diverter valve to the air intake, and remove the hose from the car.

**APR**

6) Loosen the upper 7mm clamp holding the coupler that connects the factory intake tube to the factory intake pipe.

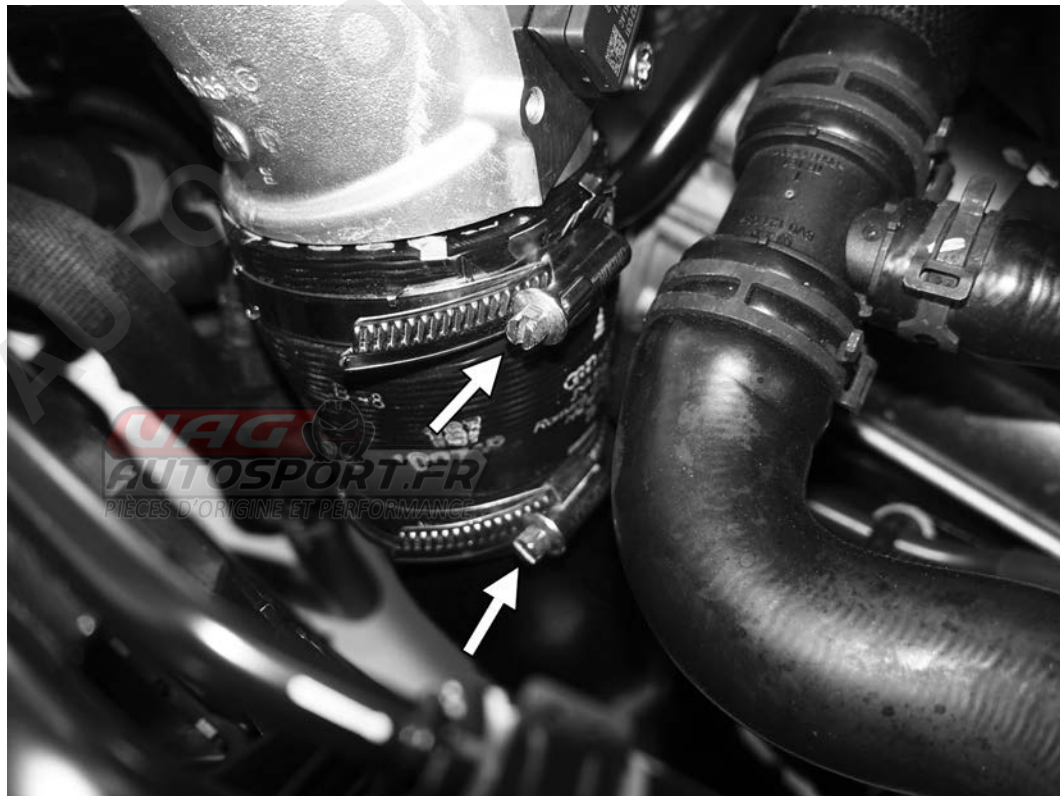

TL100132

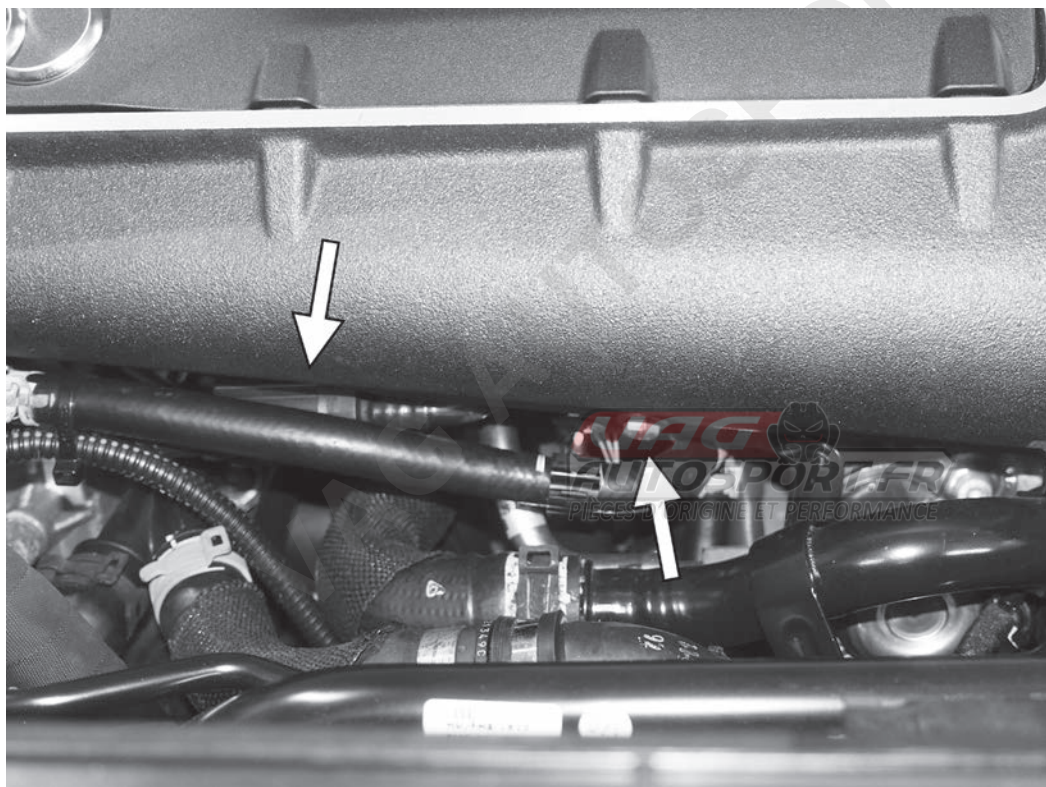

7) Under the intake manifold, remove the 10mm screw on the mounting bracket for the coolant pipe. Separate the N80 valve from its rubber mount on the bottom of the intake manifold by pushing the N80 down towards the bottom of the car.

8) Remove the five 10mm screws holding the top of the upper portion of the intake manifold to the lower portion.



TL100132

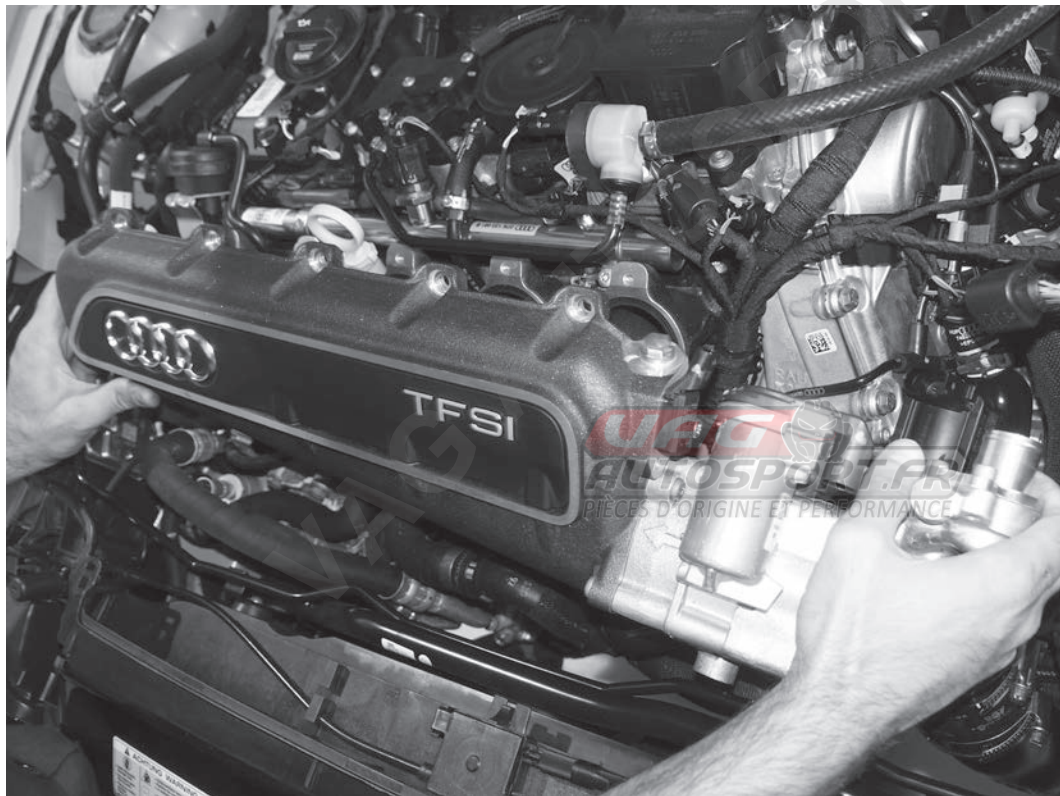

9) Carefully rotate the top of the upper portion of the intake manifold with throttle body attached away from the engine. Then lift to remove the assembly from the car.

10) Place a large, clean rag over the intake runners to prevent anything from dropping down into the engine.



TL100132



11) On the factory intake tube leading into the factory intake pipe, locate and remove the 10mm screw holding the tube to the engine. Remove the factory intake tube from the car.

**APR**

12) On the removed upper intake manifold assembly, remove the three T30 screws holding the diverter valve to the factory inlet pipe. Remove the diverter valve and place it and the screws aside. These screws will be reused. Remove the T30 screw holding the MAP sensor from the factory inlet pipe. After noting the orientation of the MAP sensor in the pipe, remove the MAP sensor.

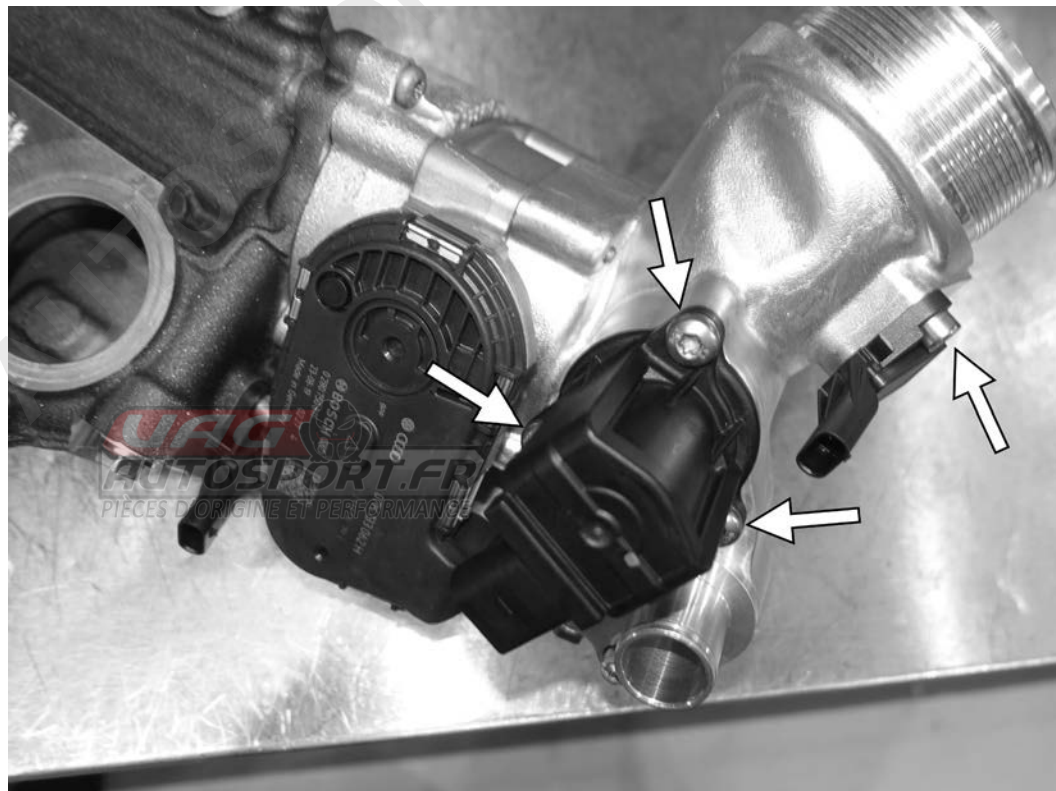

TL100132



13) On the back side of the upper manifold assembly, remove the T30 screw holding the throttle body to the intake manifold.

14) Remove the other three T30 screws holding the throttle body to the intake manifold, and then removed the throttle body from the intake manifold.



TL100132

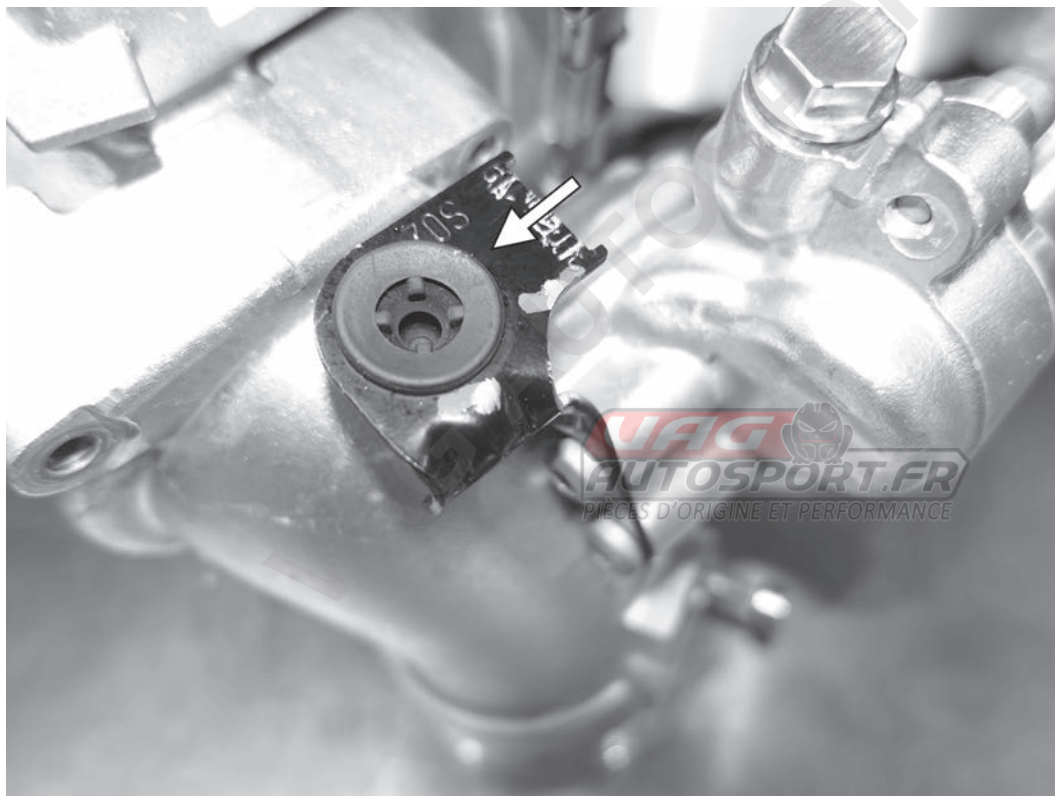

15) Remove the rubber grommet that the engine cover mounts into from the bracket on the factory cast inlet pipe.

16) Carefully pry to separate the throttle body from the factory cast inlet pipe.

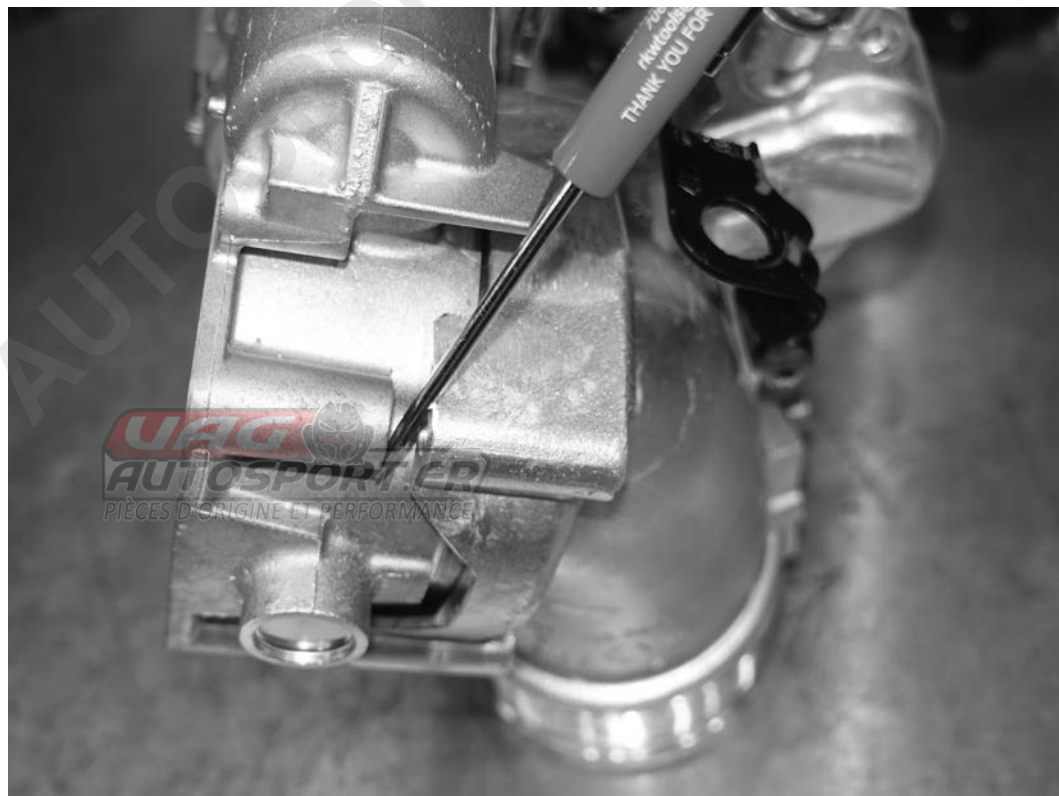

TL100132

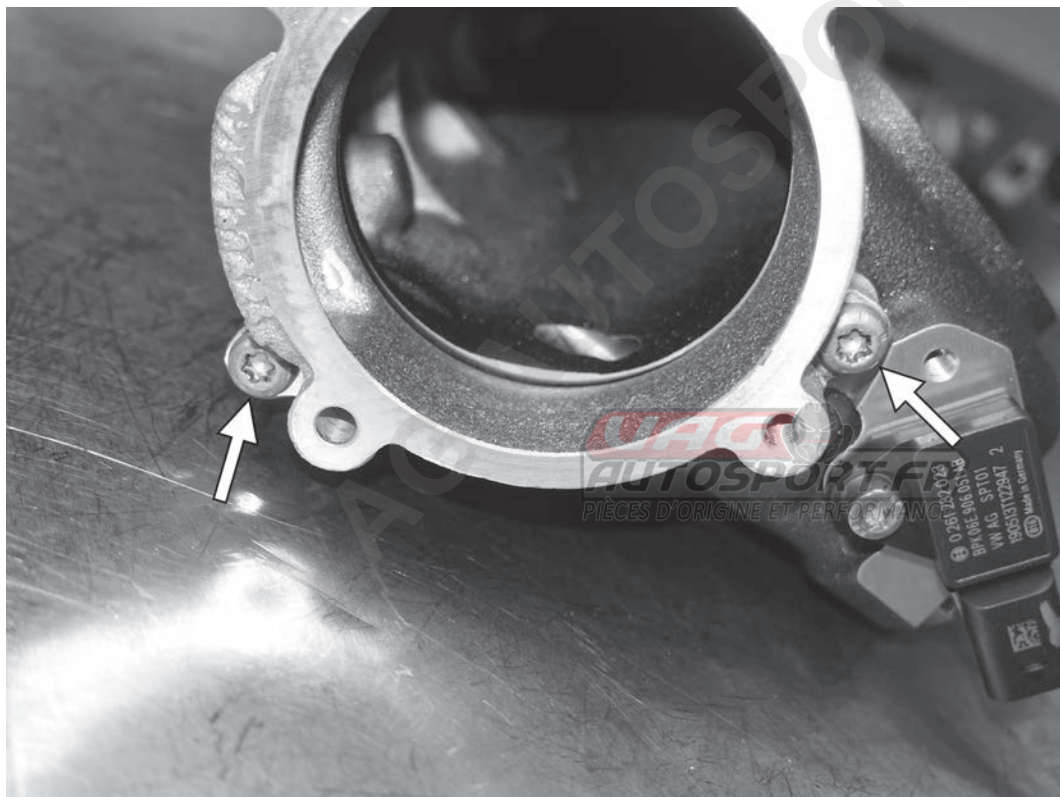

17) As viewed from where the throttle body mounted, remove the two T30 screws that hold the factory spacer to the upper intake manifold.

18) Turning the intake manifold around, remove the other two T30 screws that hold the factory spacer to the intake manifold. Remove the spacer and the old gasket from the upper intake manifold.



TL100132

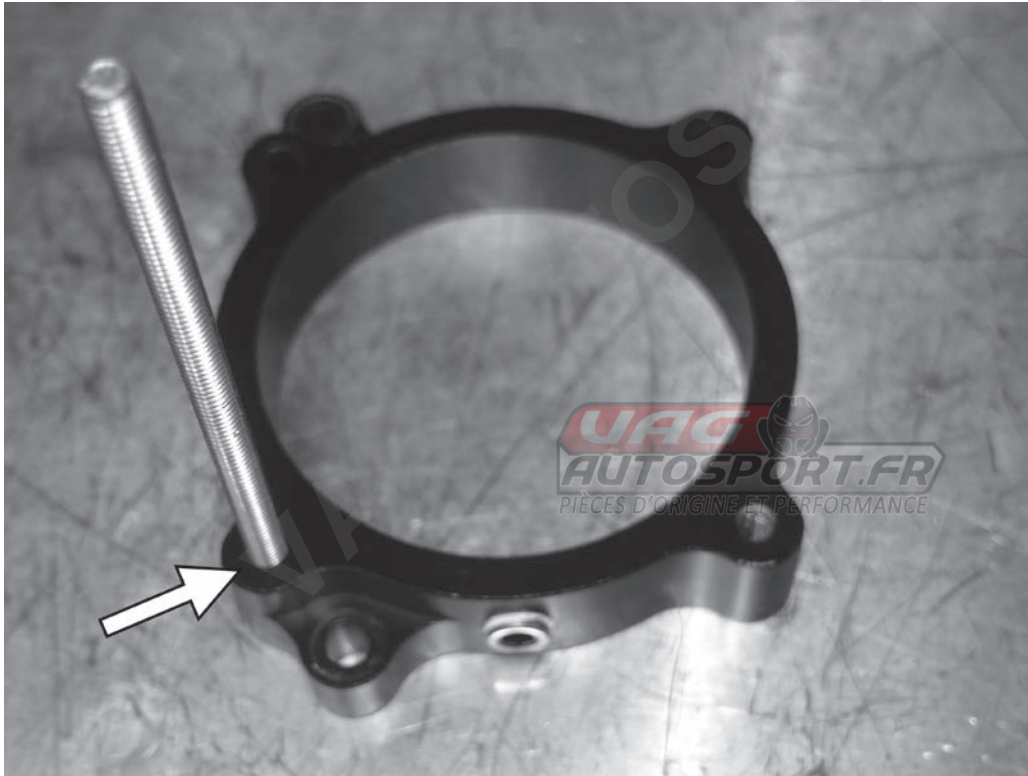

19) Put a little of the supplied Loctite 545 on the end of the supplied stud. Install the stud into the APR spacers as shown. Thread the stud all the way through the APR spacer, but do not allow it to protrude from the back side of the spacer.

**APR**

20) Install one flat washer on each of the three supplied 80mm screws. Install the screws into the three holes on the upper intake manifold with the flat washers on the outside. Finally install one of the new, supplied gaskets on the sealing surface side of the intake manifold.

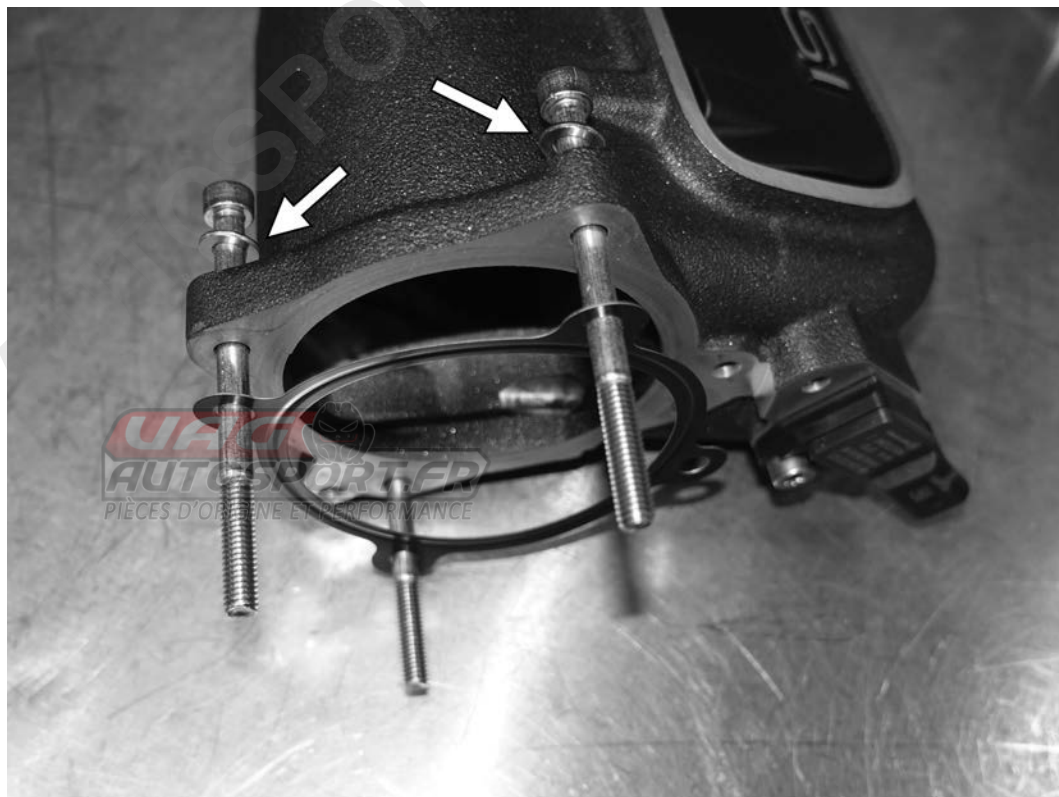

TL100132

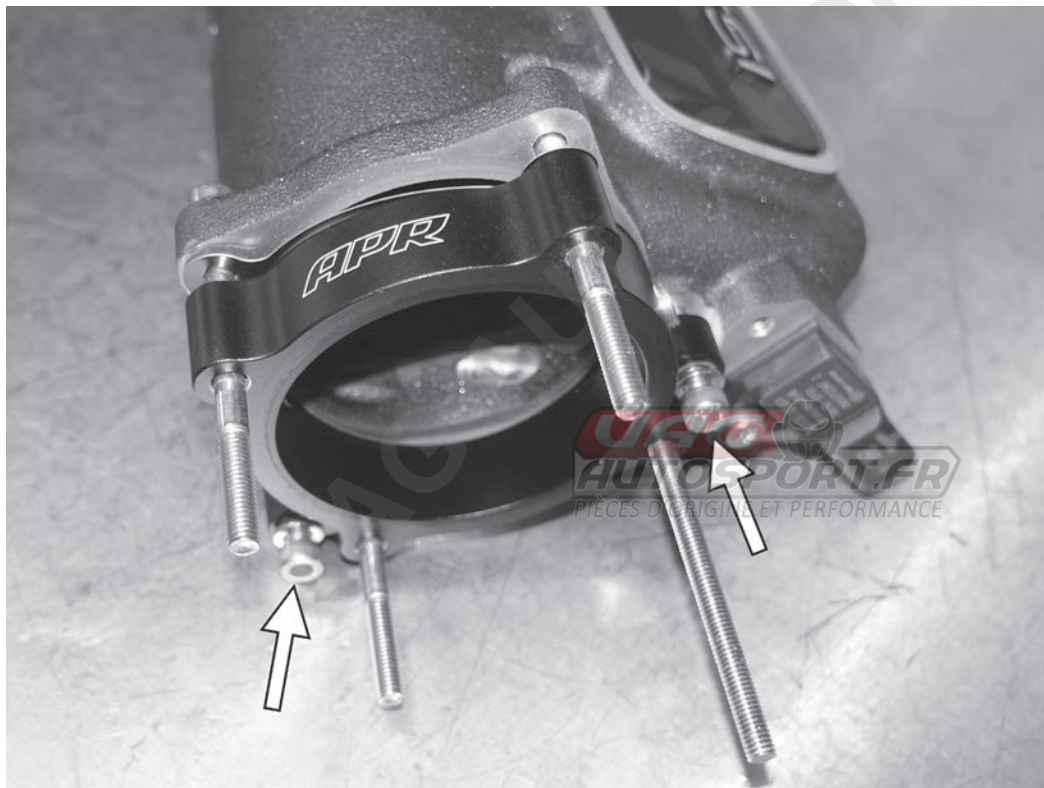

21) Install the APR spacer onto the three screws in the upper intake manifold as shown. Secure the spacer to the manifold with the two supplied 25mm screws with a flat washer on each screw. Torque these two screws to 9Nm (80 in-lbs).

**APR**

22) Install the supplied o-ring into the inside of the APR cast inlet pipe, where it would connect to the throttle body.

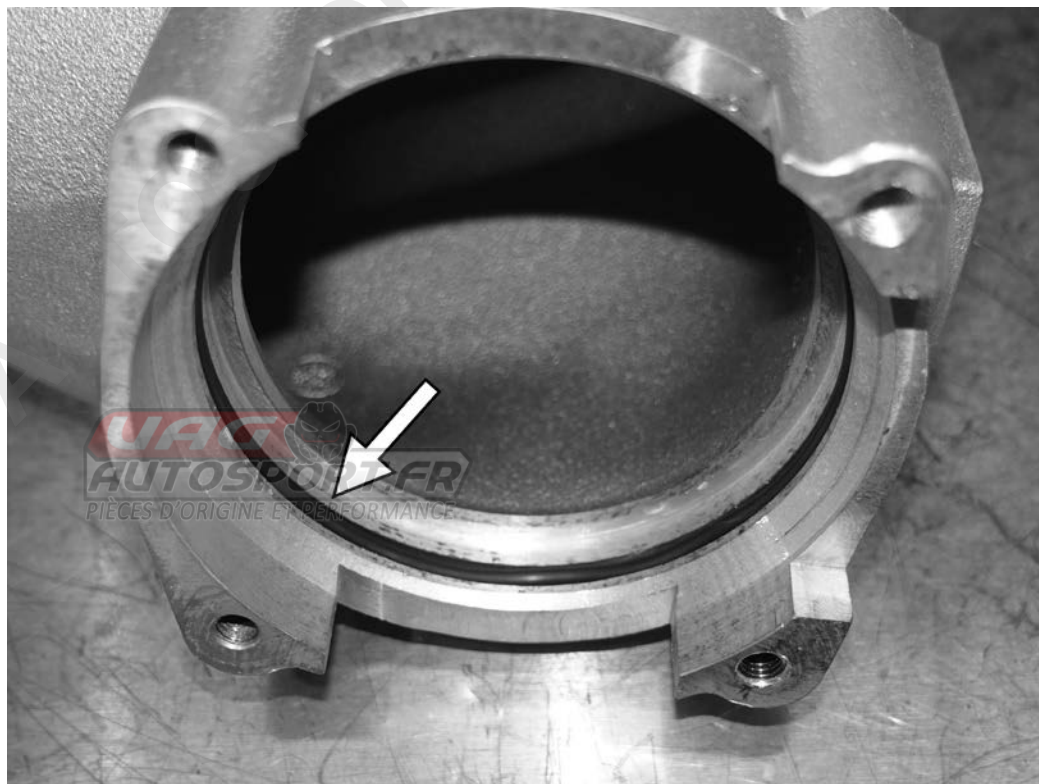

TL100132

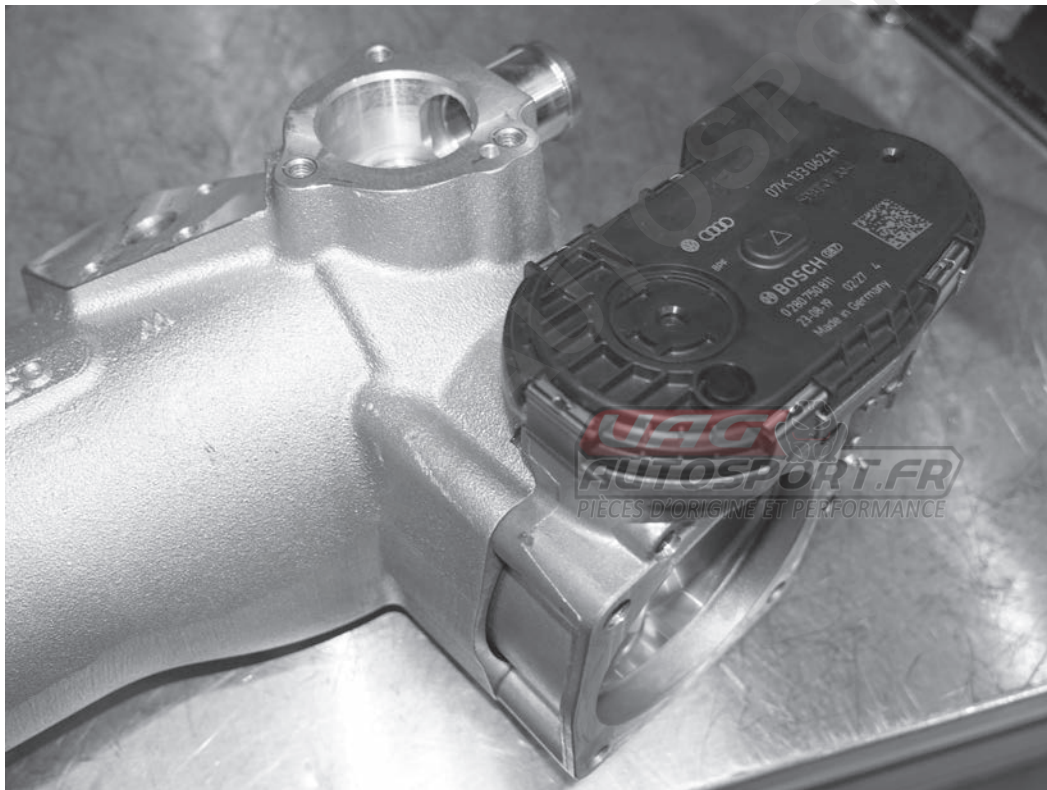

23) After lubricating the o-ring that was just installed, install the throttle body to the APR cast inlet pipe, noting the orientation of the throttle body motor to the diverter valve flange on the casting.

24) Install the MAP sensor into the APR cast inlet pipe in the same orientation as it was on the stock pipe. Secure with the shortest supplied 5mm allen screw and flat washer. Torque the screw to 9Nm (80 in-lb).

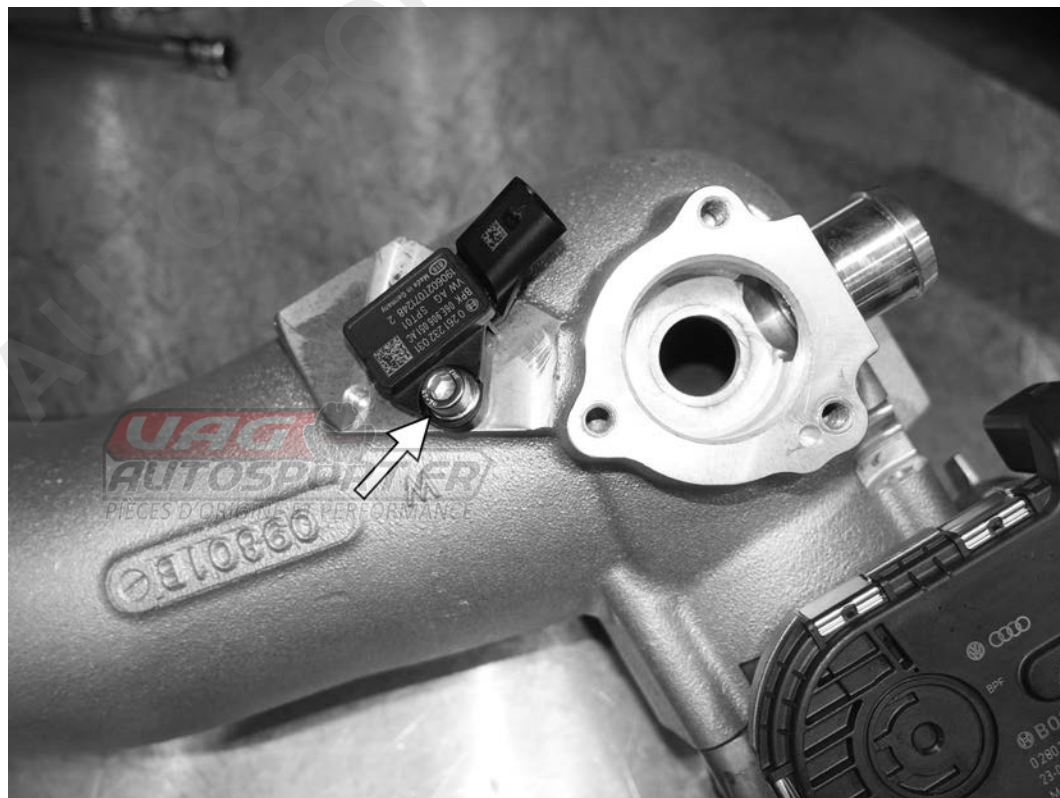

**TL100132**

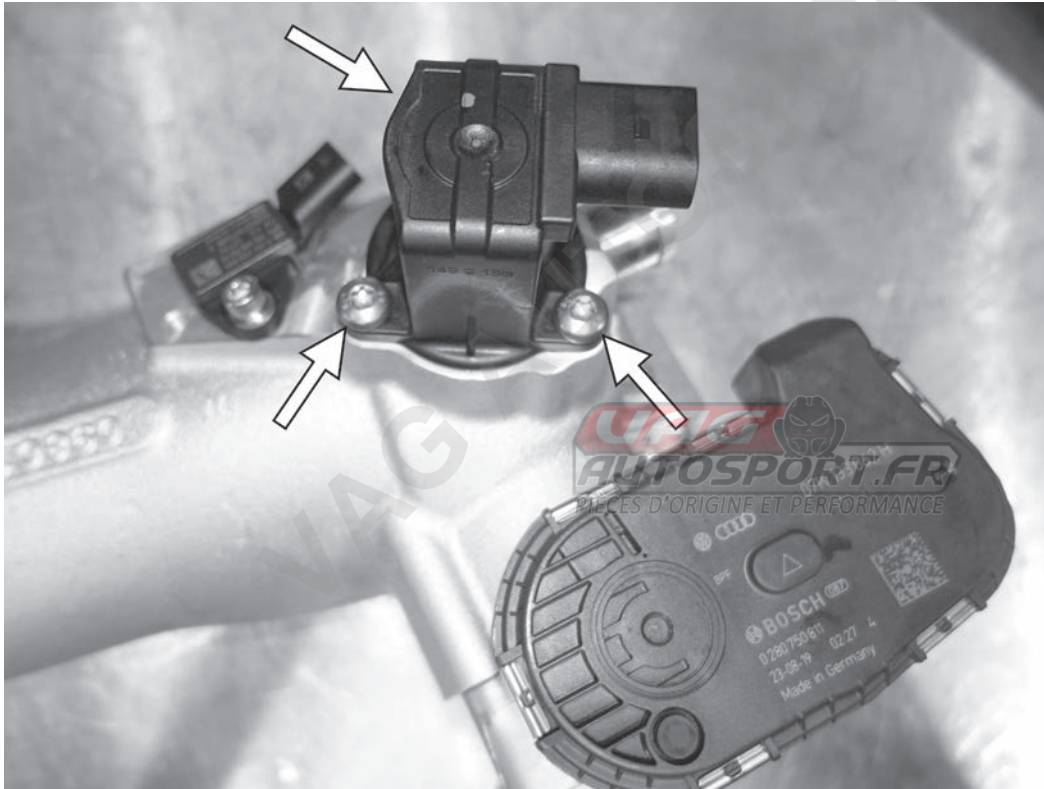

25) Install the diverter valve to the APR cast inlet pipe with the three original T30 screws. Torque the screws to 9Nm (80 in-lb).

**APR**

26) Install the second four hole gasket onto the APR spacer, and then install the throttle body with APR cast inlet pipe assembly onto the spacer. Fully thread all three 80mm screws into the APR cast inlet pipe.



TL100132

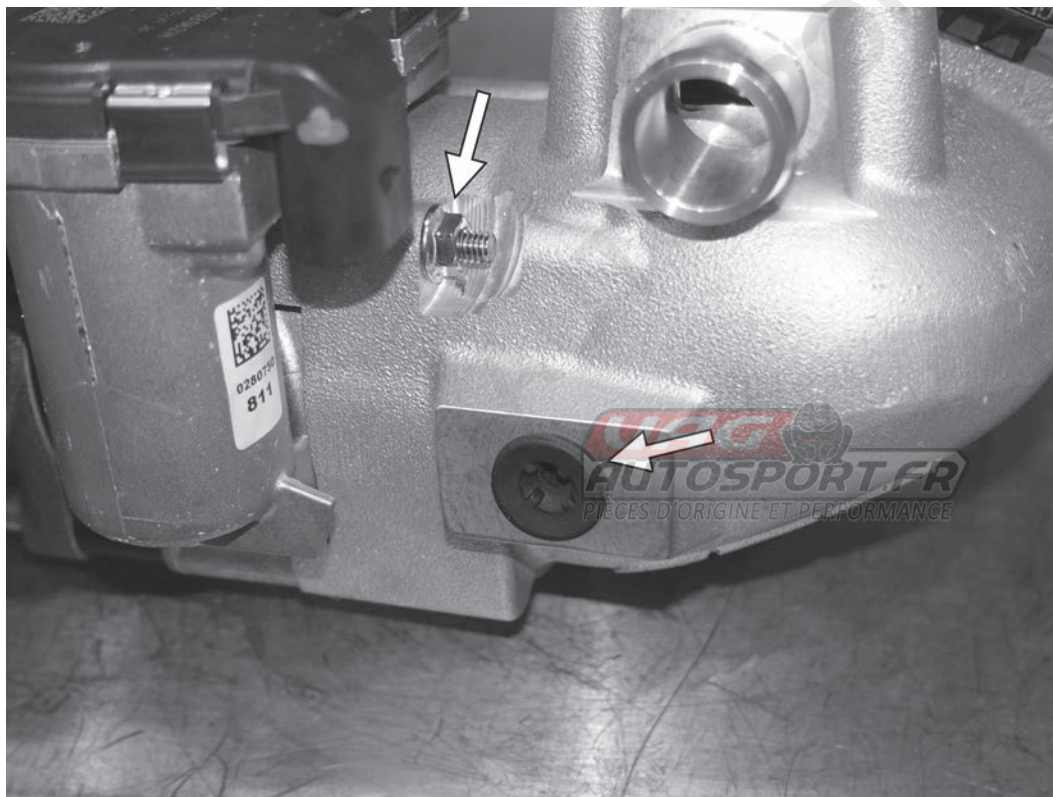

27) Install the supplied flanged nut onto the stud that is connected to the APR spacer. Torque the nut and the three 5mm allen screws to 9Nm (80 in-lb). Install the rubber engine cover mounting grommet into the top of the APR cast inlet pipe.

**APR**

28) Install the new, supplied gasket onto the lower portion of the intake manifold. Note the rubber mount for the N80 valve, that was removed in step 7.





29) Carefully place the intake manifold with APR cast inlet pipe in the car. Ensure that no wires or hoses are pinched when reinstalling, especially under the upper intake manifold.

**APR**

30) Install the five new, supplied 10mm screws along the top of the intake manifold. Torque the screws in the sequence shown to 9Nm (80 in-lb). Repeat the torquing process two more times (three times total) to complete the tightening process.



TL100132

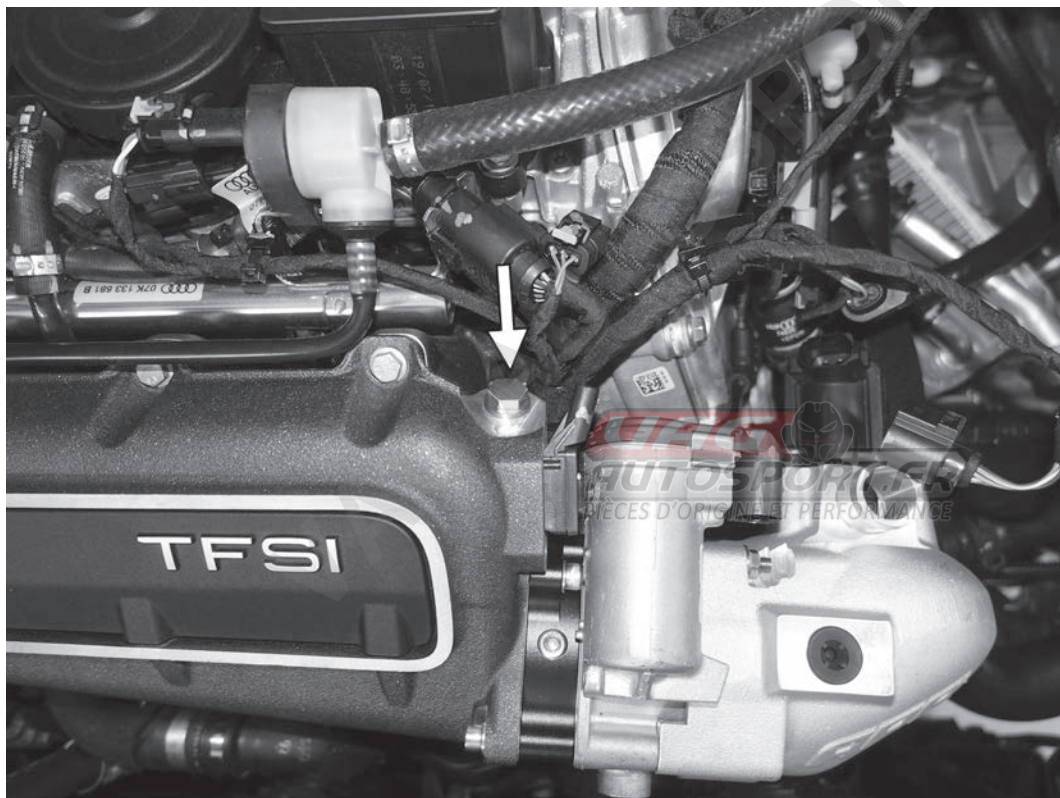

31) If installing the APR cast inlet pipe on a later car, install the supplied 13mm plug with crush washer. Torque the plug to 32Nm (24 ft-lbs).

**APR**

32) Connect the rubber mounting bracket from the N80 valve, as seen on step 28, onto the mounting bracket on the bottom of the intake manifold.



TL100132

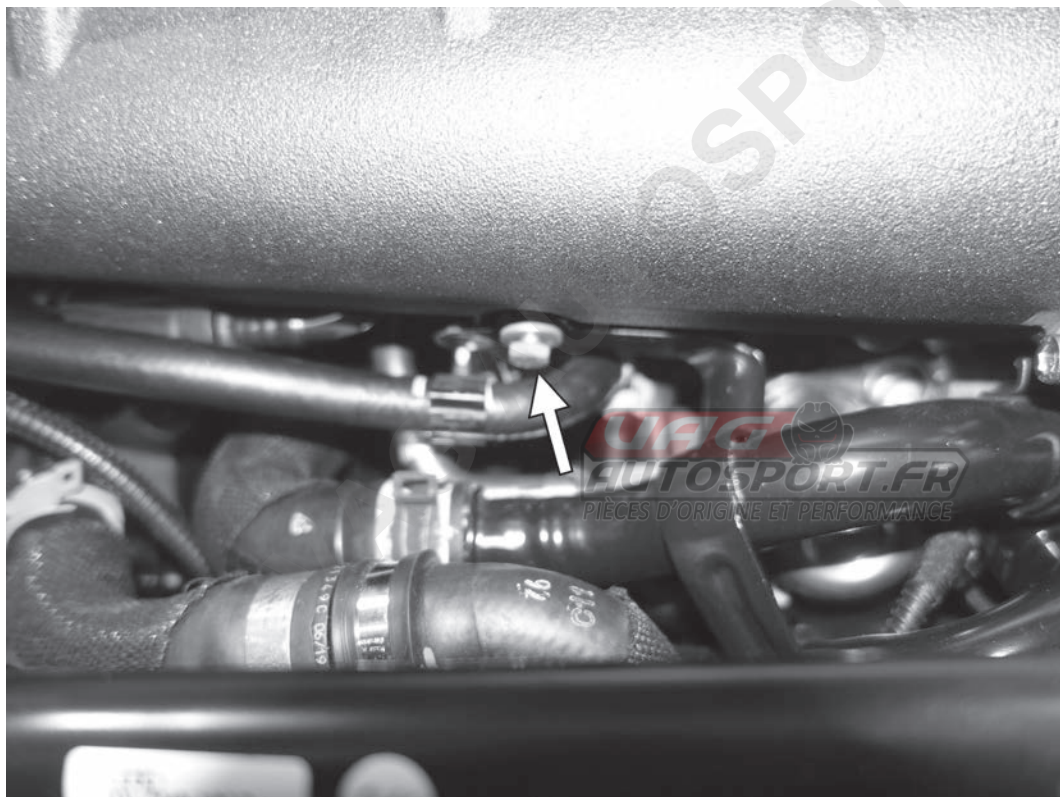

33) Reinstall the 10mm screw that holds the coolant pipe mounting bracket on the bottom of the intake manifold. Torque the screw to 9Nm (80 in-lbs)

**APR**

34) Reconnect the four electrical connectors, one for the pre-throttle body MAP sensor, one for the post-throttle body MAP sensor, the throttle body, and the diverter valve.

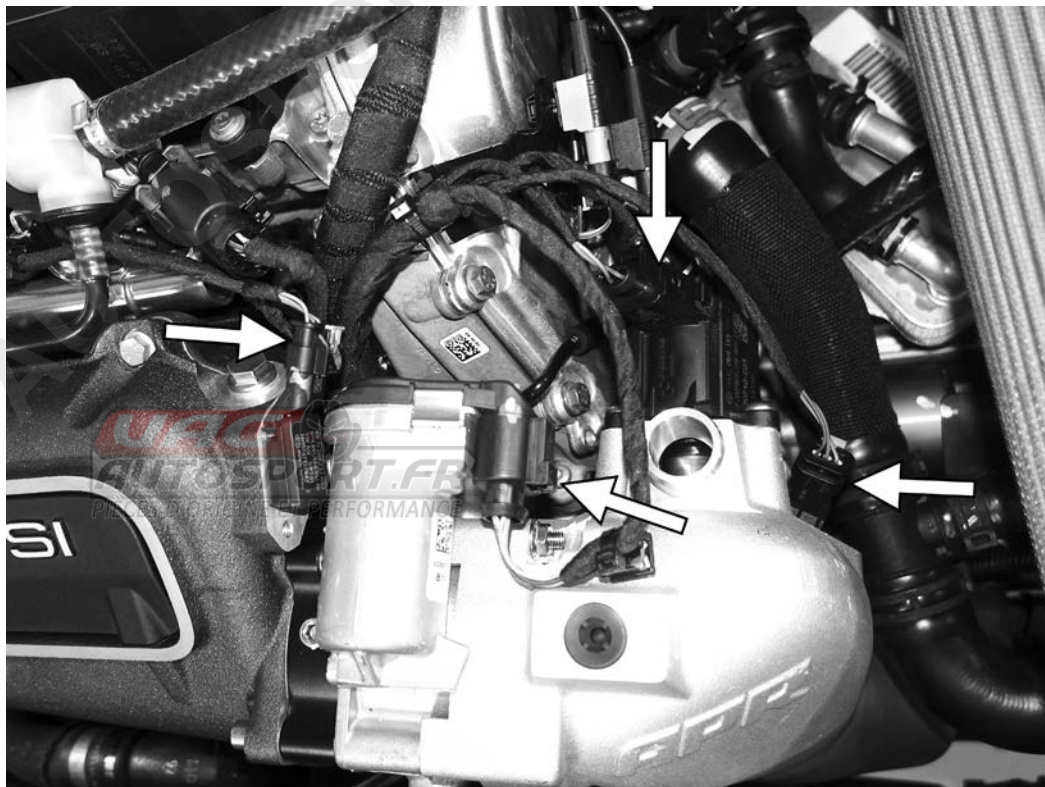

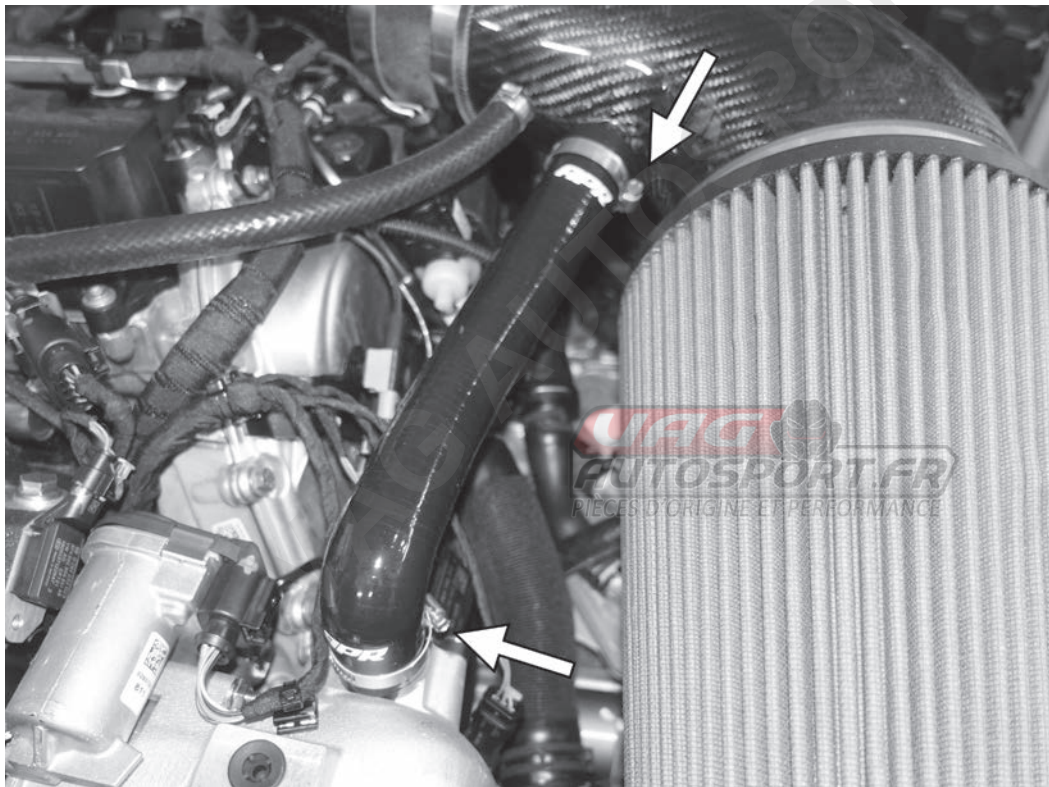

35) If the car has an APR intake, install the supplied hose between the DV outlet and the port on the APR intake. Secure the hose with the two supplied hose clamps.

**APR**

36) If the car does not have an APR intake, install the adapter port to the back of the factory airbox, and connect the hose from the the previous step between the DV and the stock airbox. Secure the hose with the two supplied hose clamps.



TL100132

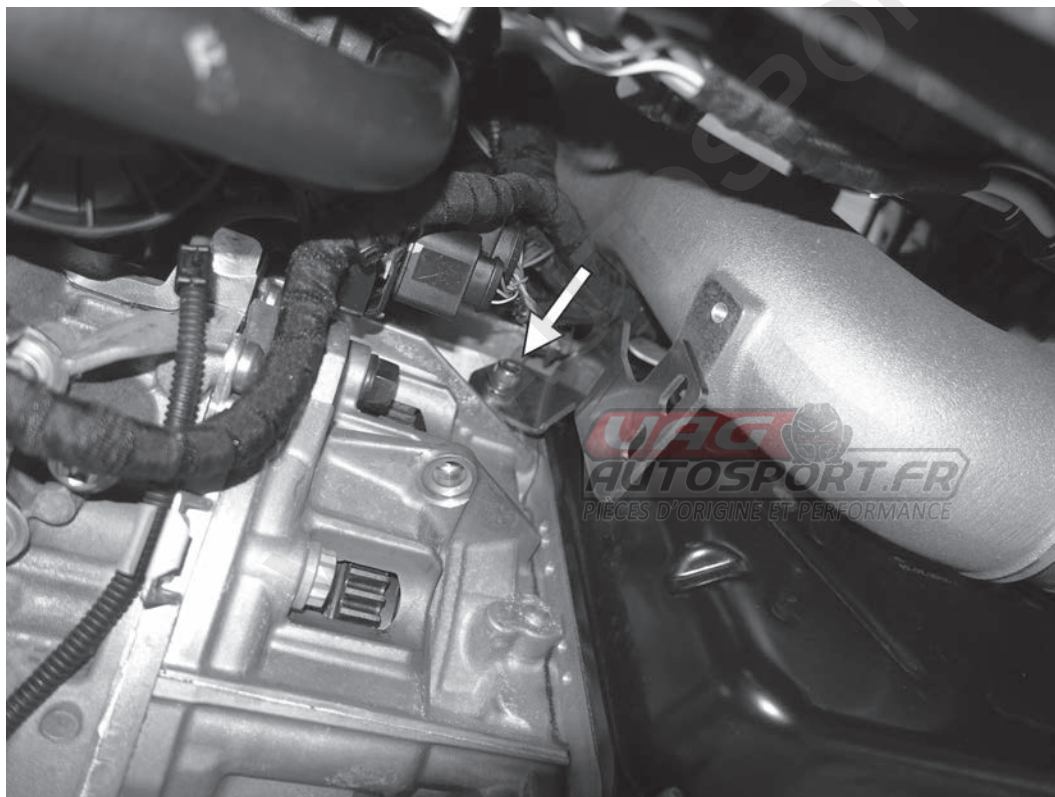

37) From underneath the car, locate the unused, tapped hole on the side of the transmission. Loosely install the APR bracket using the supplied 5mm allen screw with flat washer.

**APR**

38) Install the two supplied 5mm allen screws with flat washers to the APR cast inlet pipe. Torque all three screws holding the support bracket to 9Nm (80 in-lbs).



TL100132

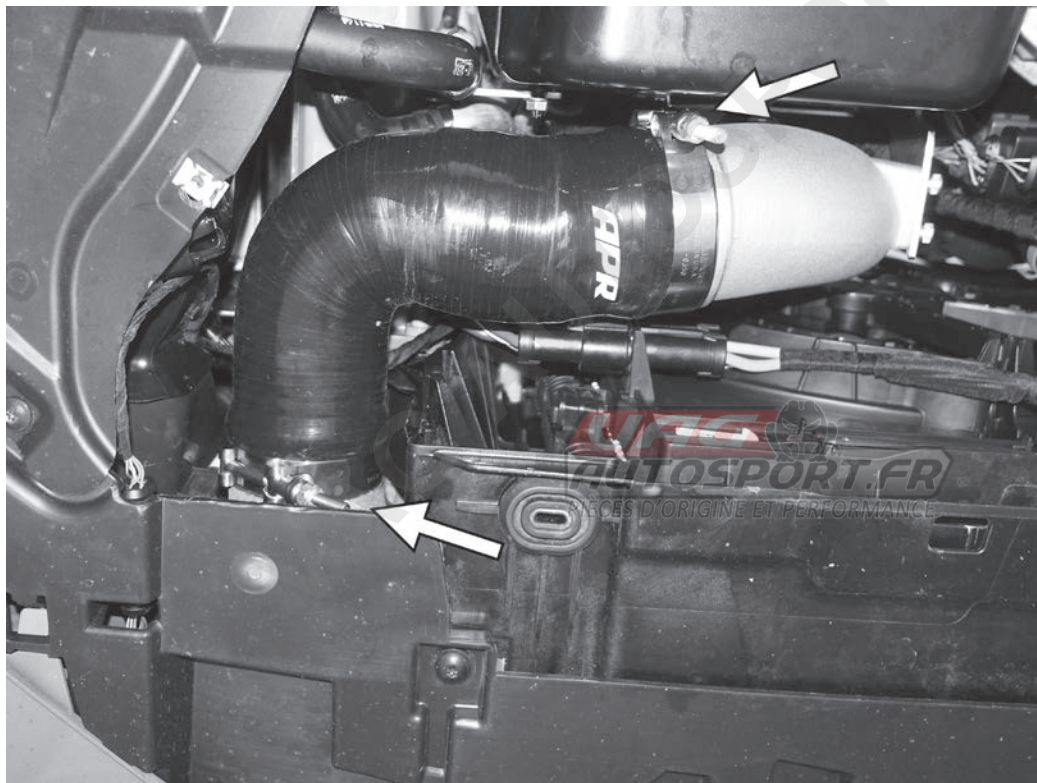

39) Install the APR lower silicone hose between the intercooler and the APR cast inlet pipe. Secure the side of the hose to the intercooler with the 3" (-0300) T-bolt clamp, and secure the side to the APR cast inlet pipe with the 3.5" (-0350) T-bolt clamp. Torque both clamps to 5.7Nm (50 in-lbs).

**APR**

40) Reinstall the belly pan on the car, making sure the front of the belly pan attaches correctly to the bottom of the bumper cover. Reinstall the three T45 screws holding the back of the belly pan. Reinstall the seven T25 screws on the sides and front of the belly pan.

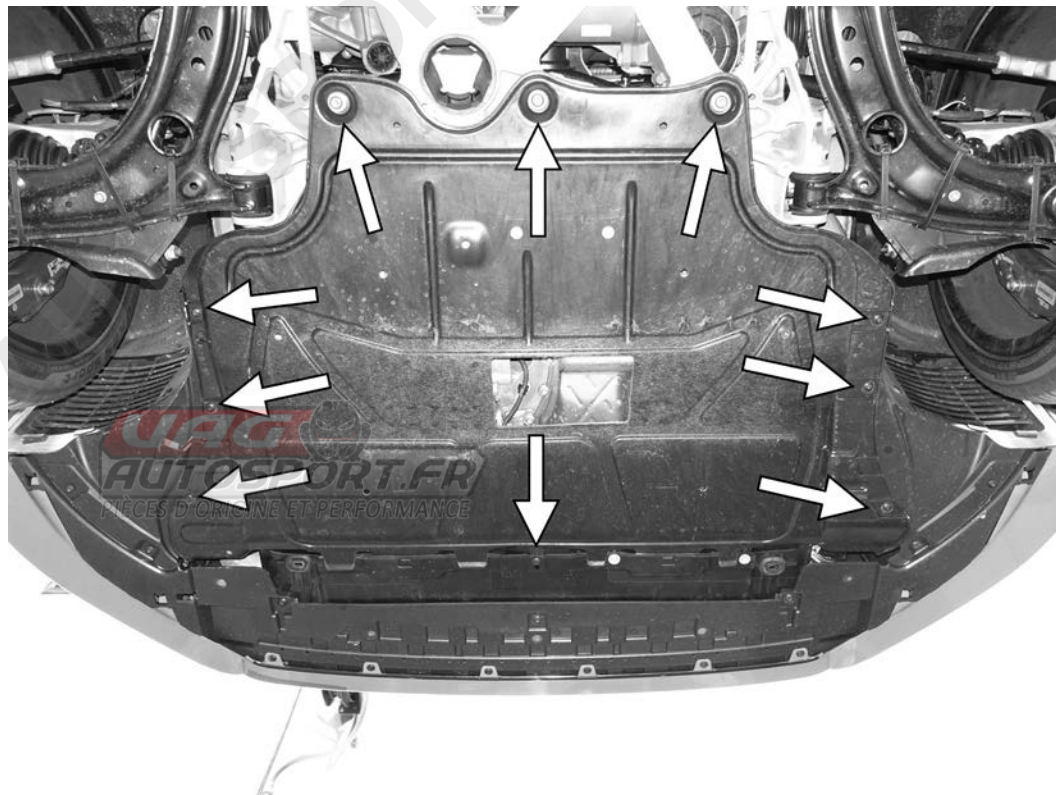

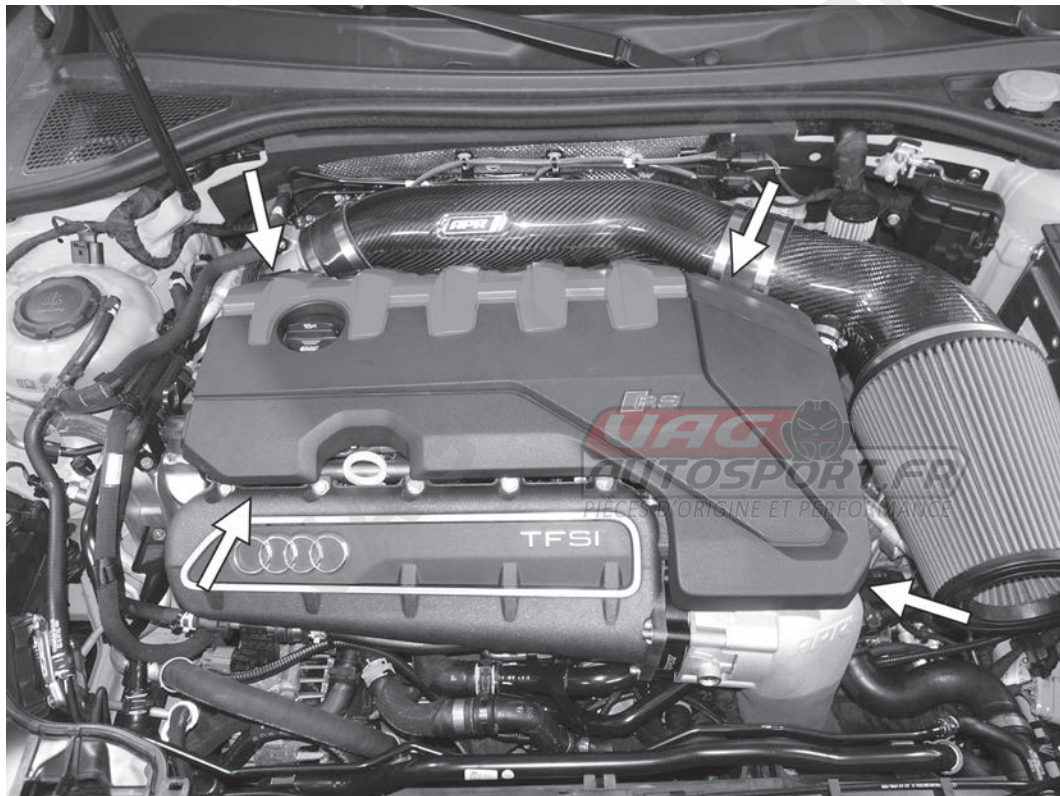

41) Reinstall the engine cover by pressing the cover down onto the four mounting posts on the engine.

VAG AUTOSPORT



TL100132

#TL100132

VAG AUTOSPORT



***GO APR.COM***