



VAG
AUTOSPORT.FR
PIÈCES D'ORIGINE ET PERFORMANCE

RS4 SUPERCHARGER INSTALLATION INSTRUCTIONS

APR, LLC

4800 U.S. HWY 280 West Opelika Alabama 36801



professional

download the free trial online at nitropdf.com/professional

VAG AUTOSPORT - vag-autosport



APR, LLC
Alabama 36801
4800 US HWY 280 West Opelika

Created with



download the free trial online at nitropdf.com/professional

Notes:

These instructions were written on a 2008 RS4, but there are minor variations throughout the model run of the RS4.

When disassembling the car, be sure to keep and mark all fasteners so they can be reused. It is recommended that you get some kind of compartmented tray to organize the fasteners, such as a fishing tackle box or several large ice cube trays. Fasteners that are not reused for reinstallation are noted in the instructions.

These instructions assume that you have moderate mechanical skills and several varieties of the tools listed in order to install the kit. If you have any questions about the install, feel free to contact your APR representative.

Created with



nitro PDF[®]

download the free trial online at nitropdf.com/professional

APR, LLC

4800 US HWY 280 West Opelika Alabama 36801

1) Remove the three T30 screws from the upper part of the front bumper.

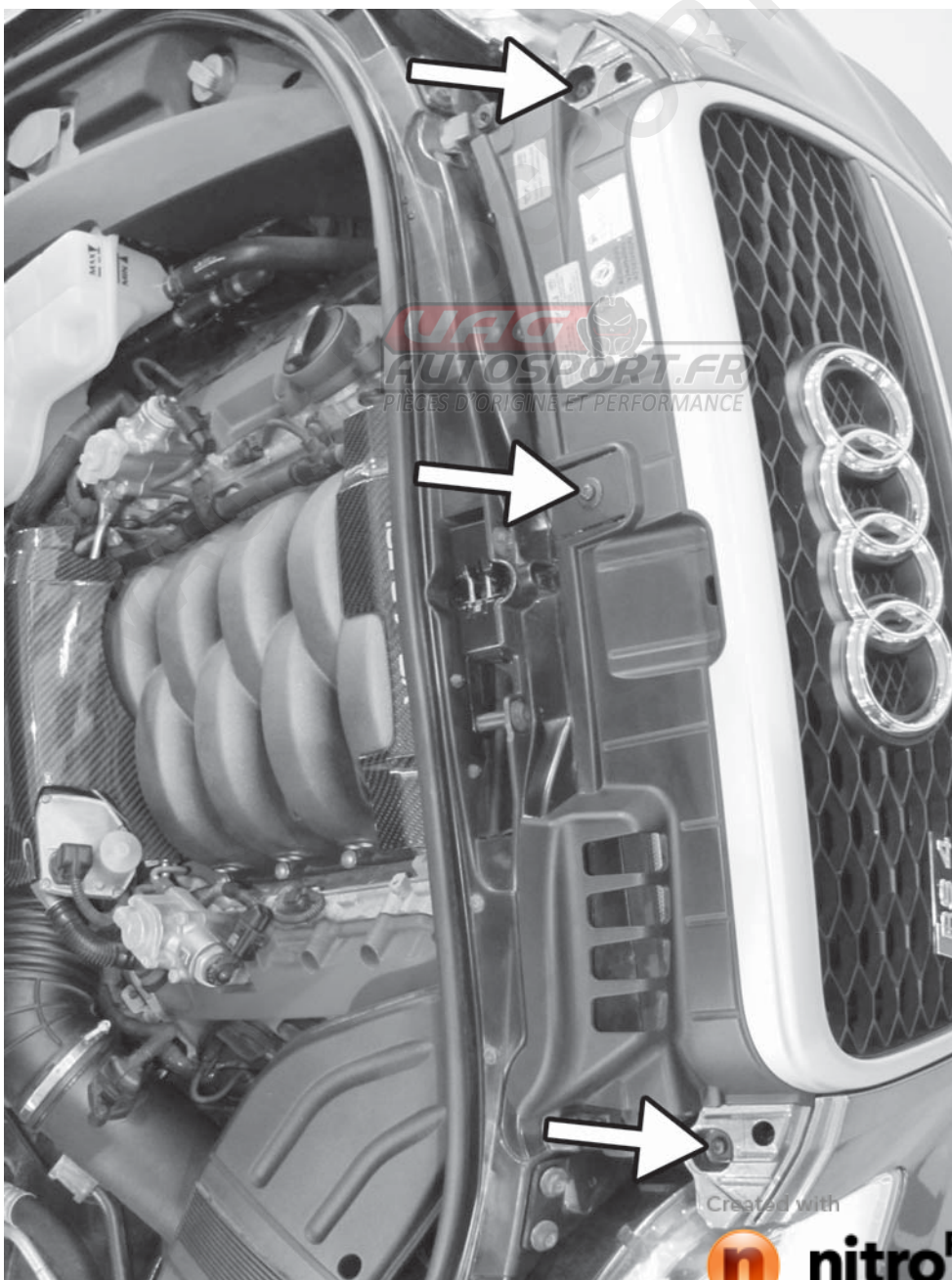

APR, LLC
4800 US HWY 280 West Opelika Alabama 36801

2) Remove the front wheels. Disconnect the fourteen (seven on each side) T25 Torx screws and four (two on each side) push tabs that hold the front half of fender liner to the car. Also remove the six (three on each side) T25 Torx screws that connect the brake cooling duct to the fender liner. Carefully bend the liner back behind the brake rotor so that it is out of the way.

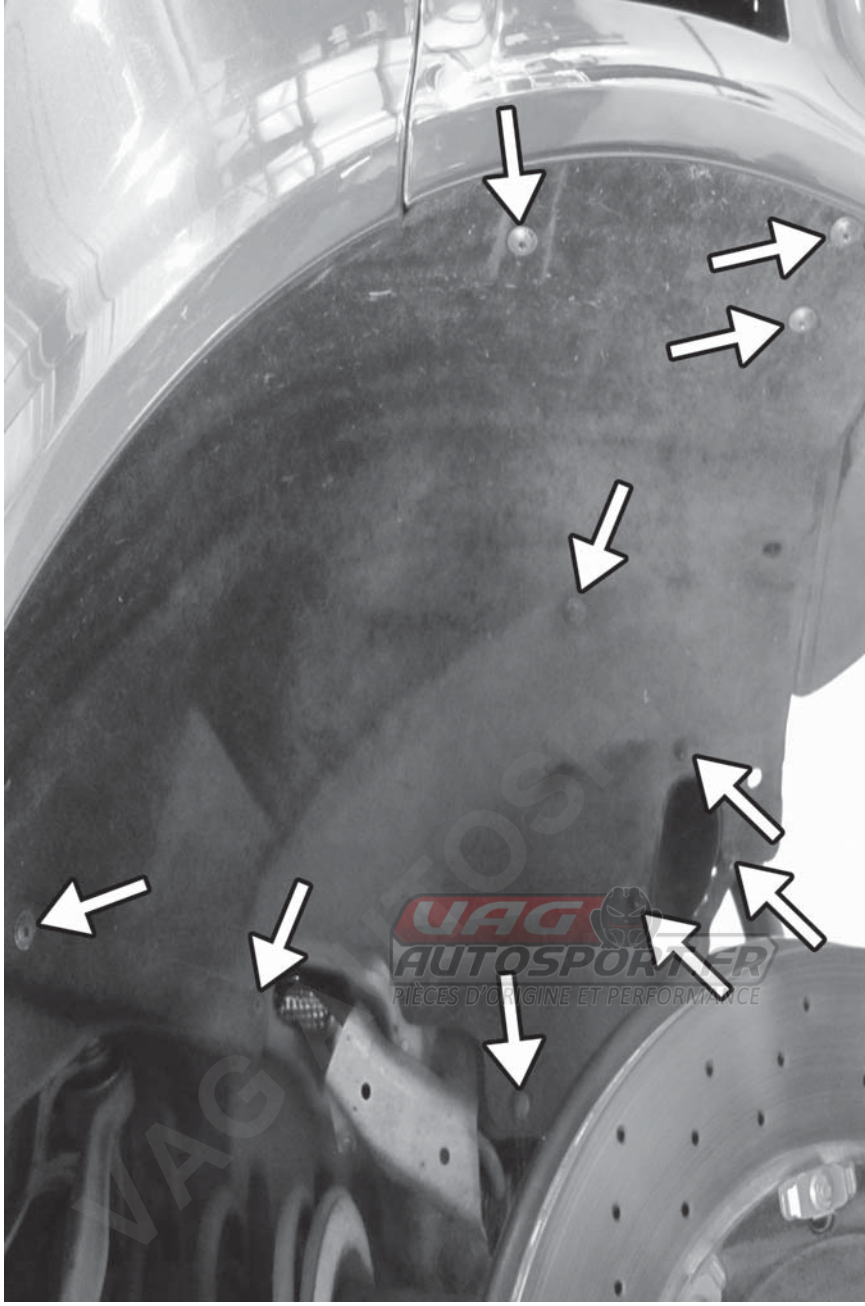

Created with



nitroPDF[®]

professional

download the free trial online at nitropdf.com/professional

APR, LLC
4800 US HWY 280 West Opelika Alabama 36801

3) Remove the screws and quick release fasteners that hold the belly pan in place. The brake cooling ducts are removed with the belly pan.

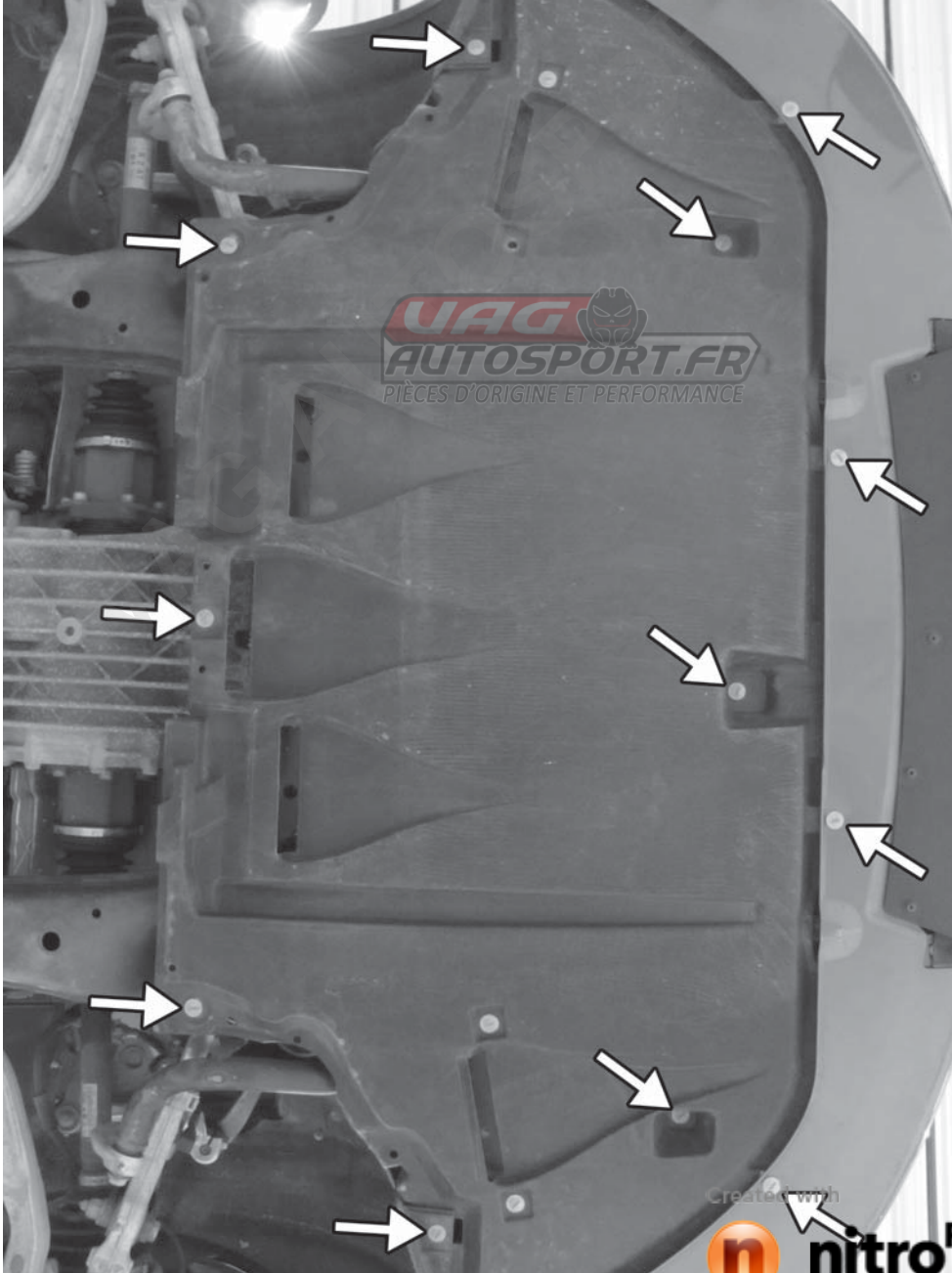

APR, LLC
Alabama 36801
4800 US HWY 280 West Opelika

4) Remove the four (two on each side) T25 Torx screws that connect the fender with the bumper cover and the bumper cover with the support brace.

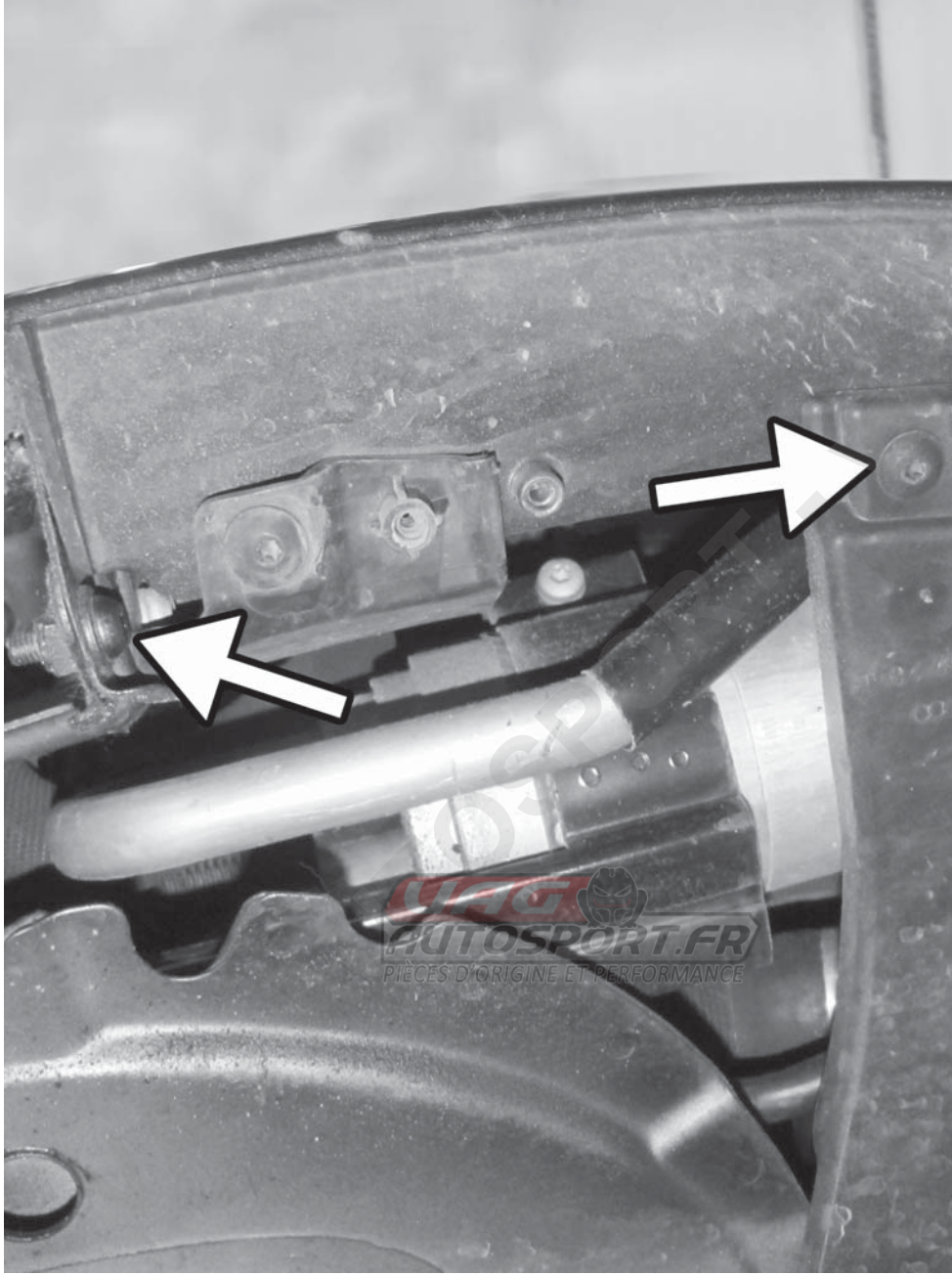

Created with

 **nitro** PDF[®] professional

download the free trial online at nitropdf.com/professional

APR, LLC
4800 US HWY 280 West Opelika Alabama 36801

5) Remove the four (two on each side) 10MM nuts that connect the fender to the front bumper cover.

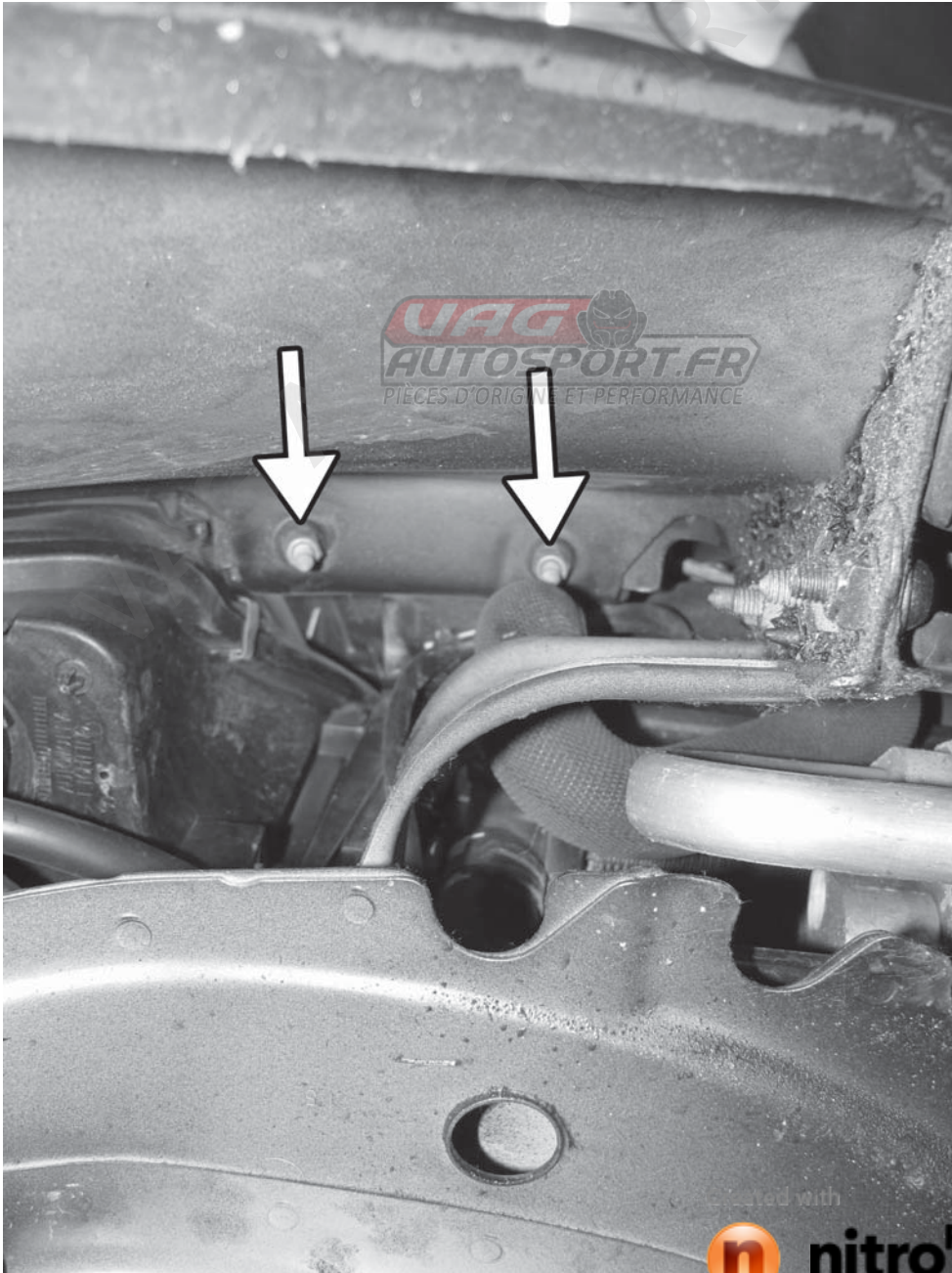

APR, LLC
Alabama 36801
4800 US HWY 280 West Opelika

6) Remove the two T30 Torx Screws that connect the bumper cover to the bumper crash beam. They are accessed through the holes in the top of the bumper cover.

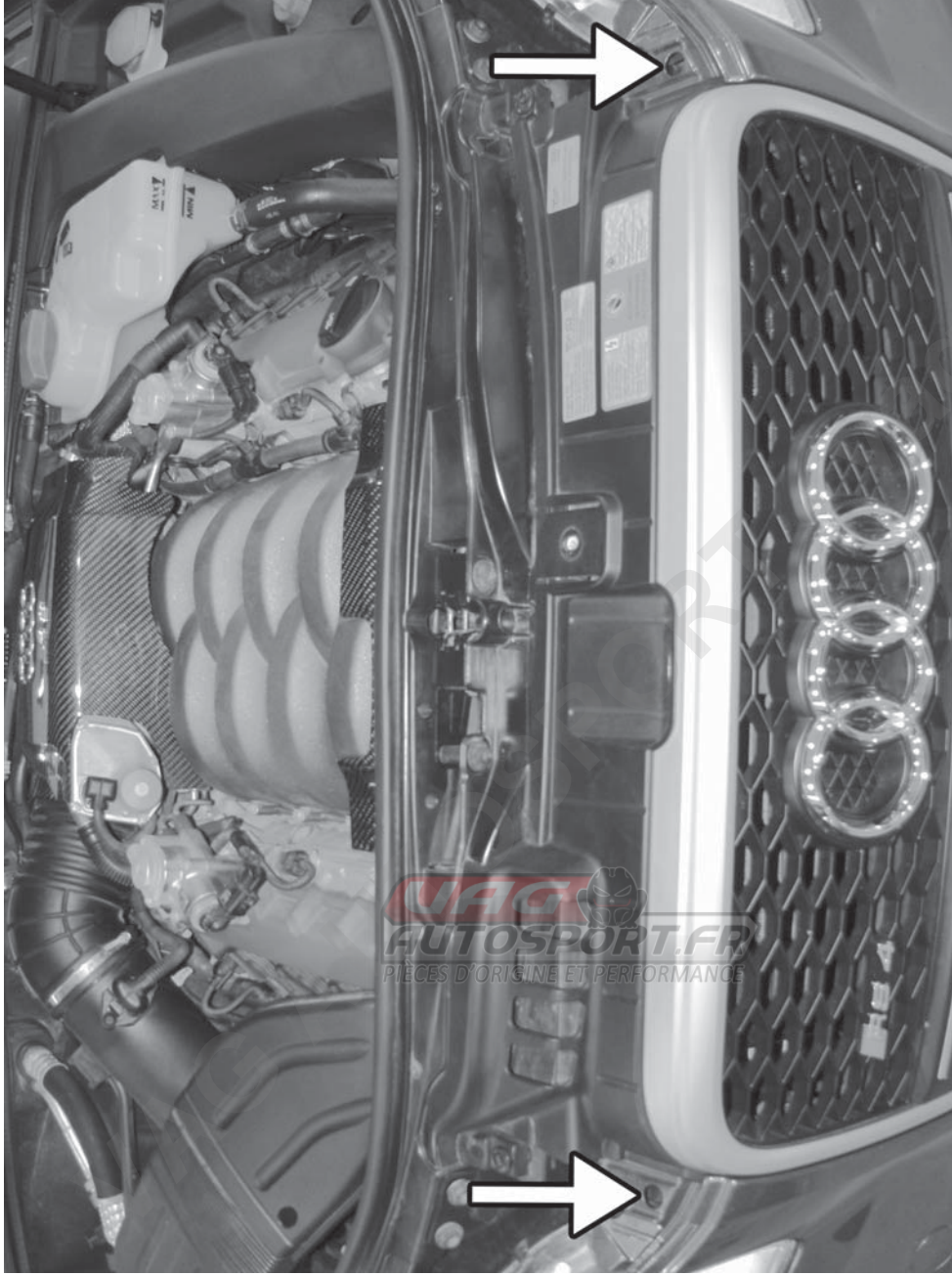

Created with



nitroPDF[®]

professional

download the free trial online at nitropdf.com/professional

APR, LLC
4800 US HWY 280 West Opelika Alabama 36801

7) With an assistant, carefully pull the bumper cover towards the front of the car. Be sure not to scratch the paint with the mounting screws or the cover itself. Pull the cover forward approximately 12 inches in order to access the electrical connector and headlight washer hose on the left side.



APR, LLC
Alabama 36801
4800 US HWY 280 West Opelika

Created with



nitro PDF

professional

download the free trial online at nitropdf.com/professional

8) Disconnect the three electrical connections on the left side of the bumper cover.

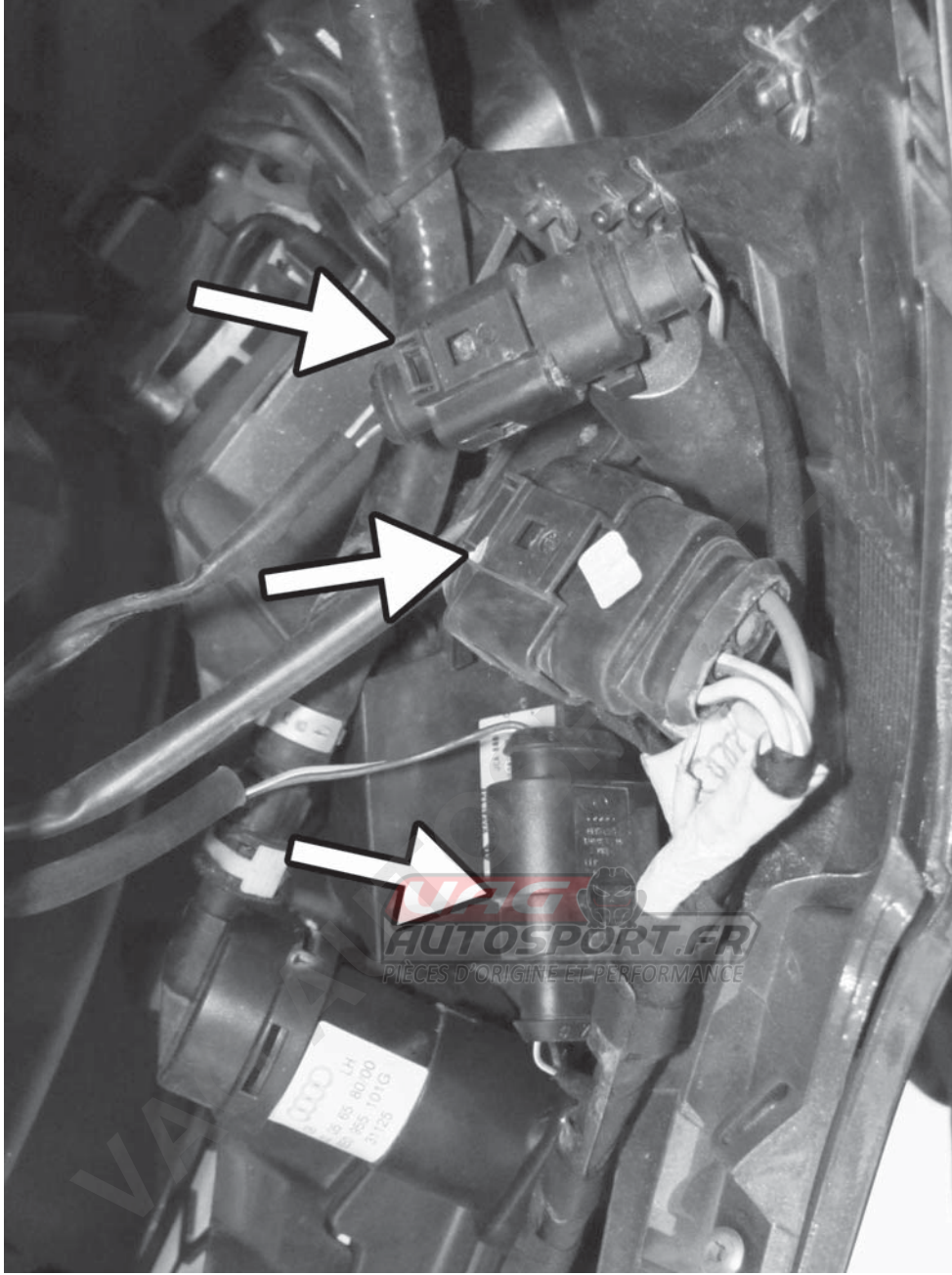

Created with



nitro PDF[®]

professional

download the free trial online at nitropdf.com/professional

APR, LLC
4800 US HWY 280 West Opelika Alabama 36801

9) Using a bucket or drain pan, disconnect the headlight washer hose with the quick disconnect clip. Most all of the fluid in the windshield/headlight washer tank will drain. This can be saved and reused or discarded. Remove the bumper cover and set aside in a safe location.

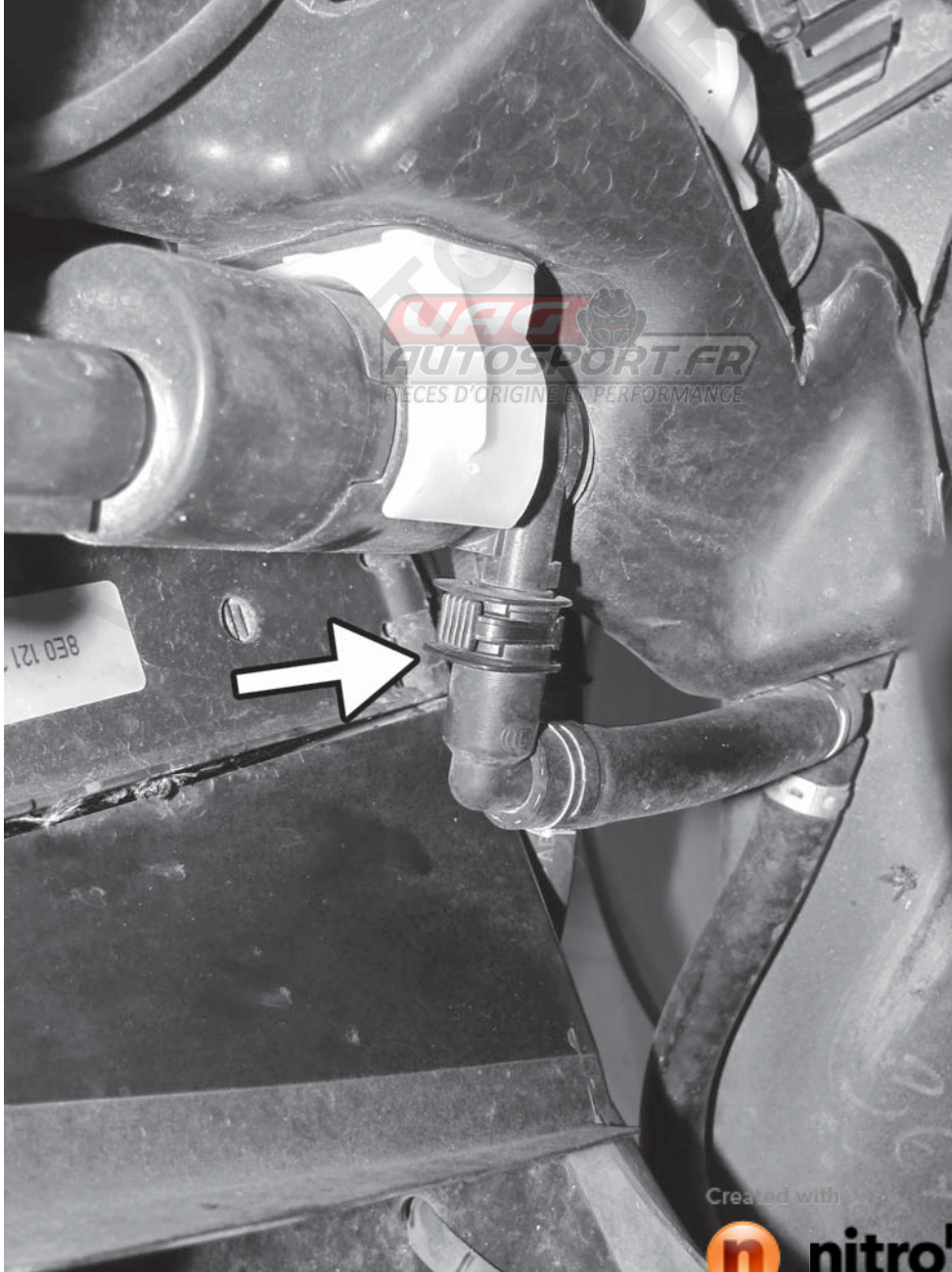

APR, LLC
Alabama 36801
4800 US HWY 280 West Opelika

Created with



nitro PDF

professional

download the free trial online at nitropdf.com/professional

10) Remove the two phillips screws that connect the air intake guide to the radiator core support. Remove the intake guide from the car.

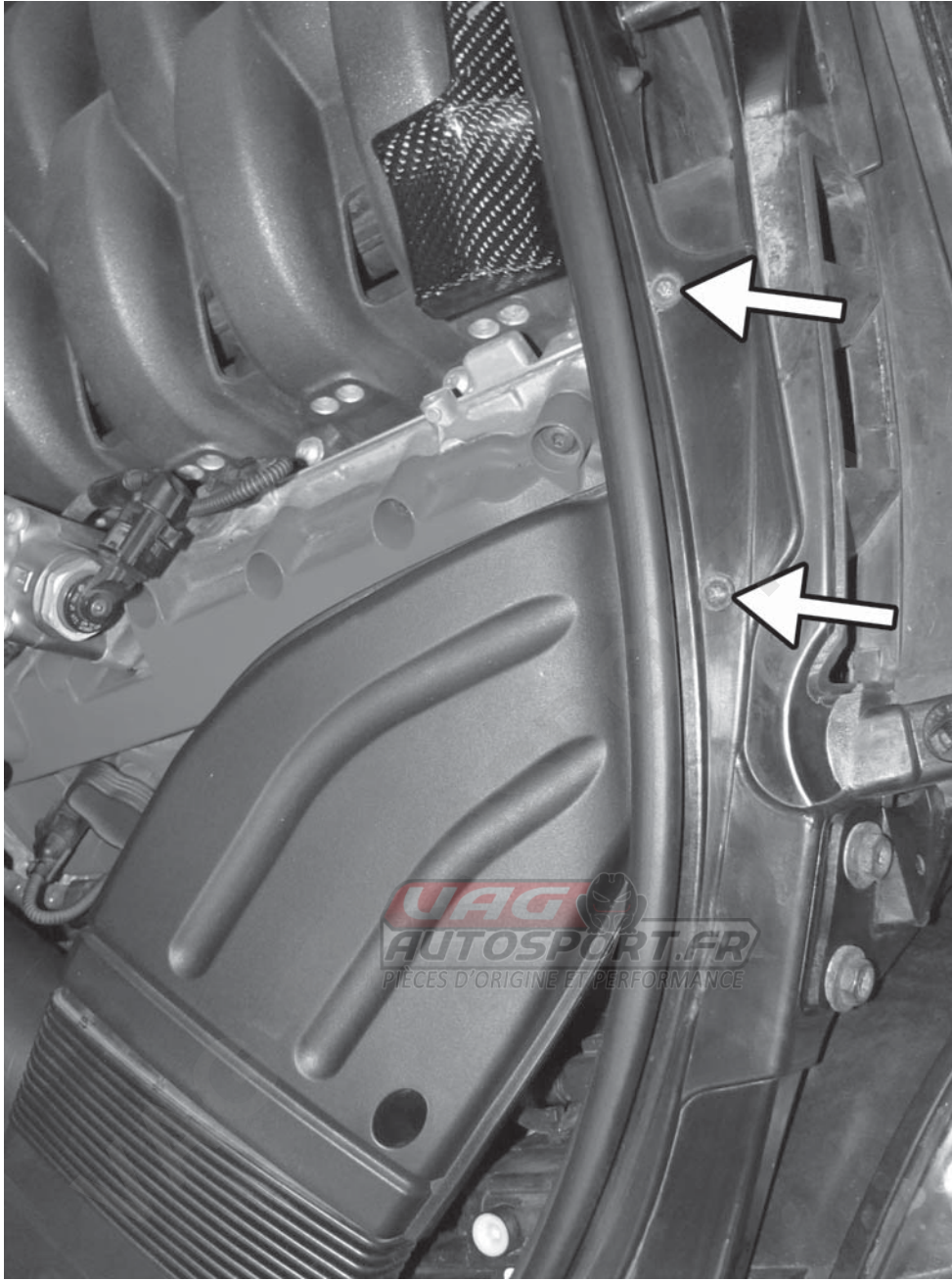

Created with

 **nitro** PDF[®] professional

download the free trial online at nitropdf.com/professional

APR, LLC
4800 US HWY 280 West Opelika Alabama 36801

11) Remove the T30 Torx screw on the front of the left side engine bay cover and then remove the cover. Remove the weather stripping from the front and back of the engine bay.



APR, LLC
Alabama 36801
West Opelika
4800 US HWY 280

Created with



nitro PDF

professional

download the free trial online at nitropdf.com/professional

12) Unplug the three electrical connections on the fan control module. Unclip the fan wiring harness from the support tabs on the bumper beam. Also unplug the electrical connectors from the horns, located on either side of the bumper beam.

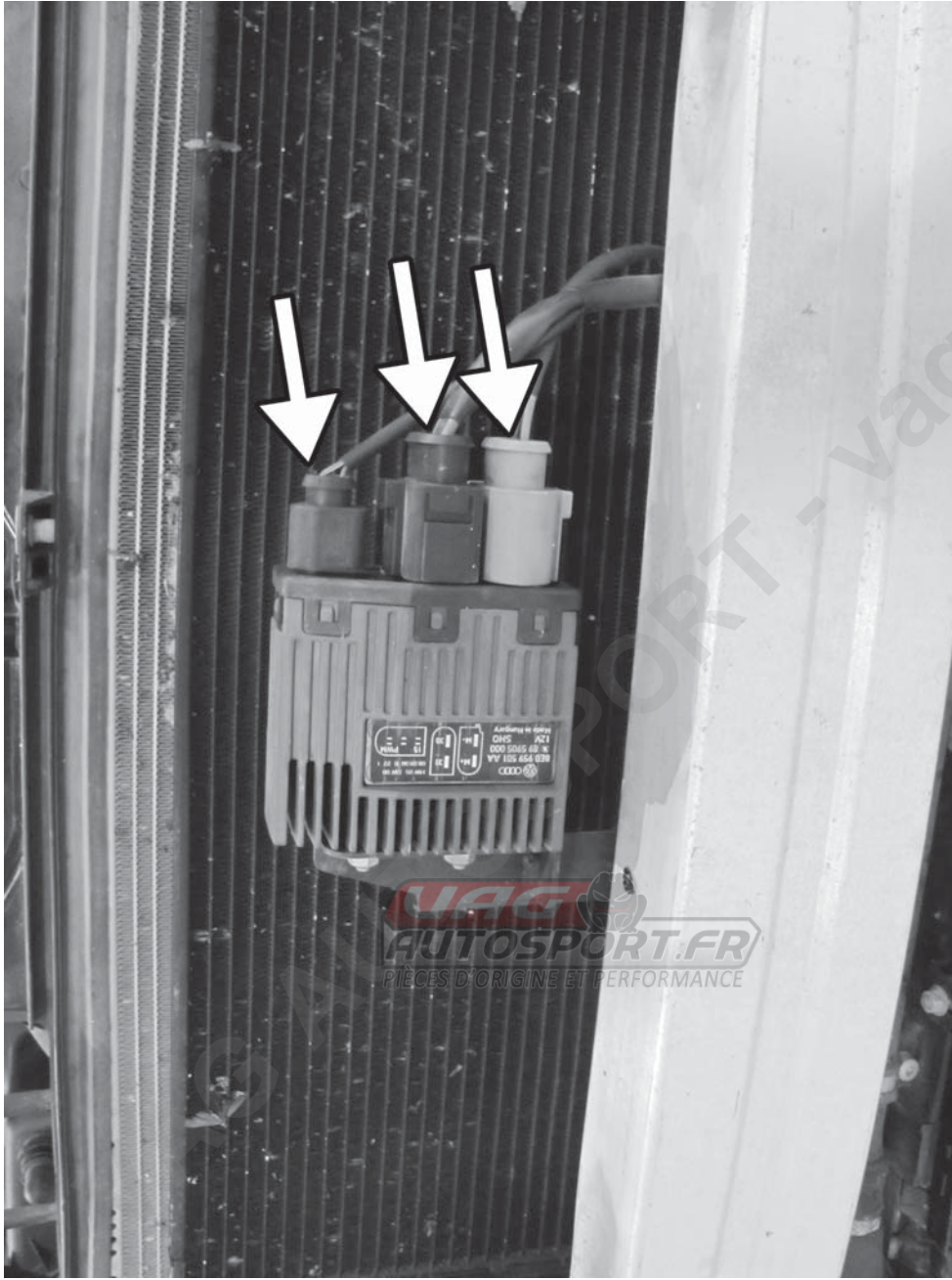

Created with

 **nitro** PDF[®] professional

download the free trial online at nitropdf.com/professional

APR, LLC
4800 US HWY 280 West Opelika Alabama 36801

13) Remove the two 10MM triple square screws from the bottom of the bumper crash beam and remove the bumper crash beam and remove the beam from the car.

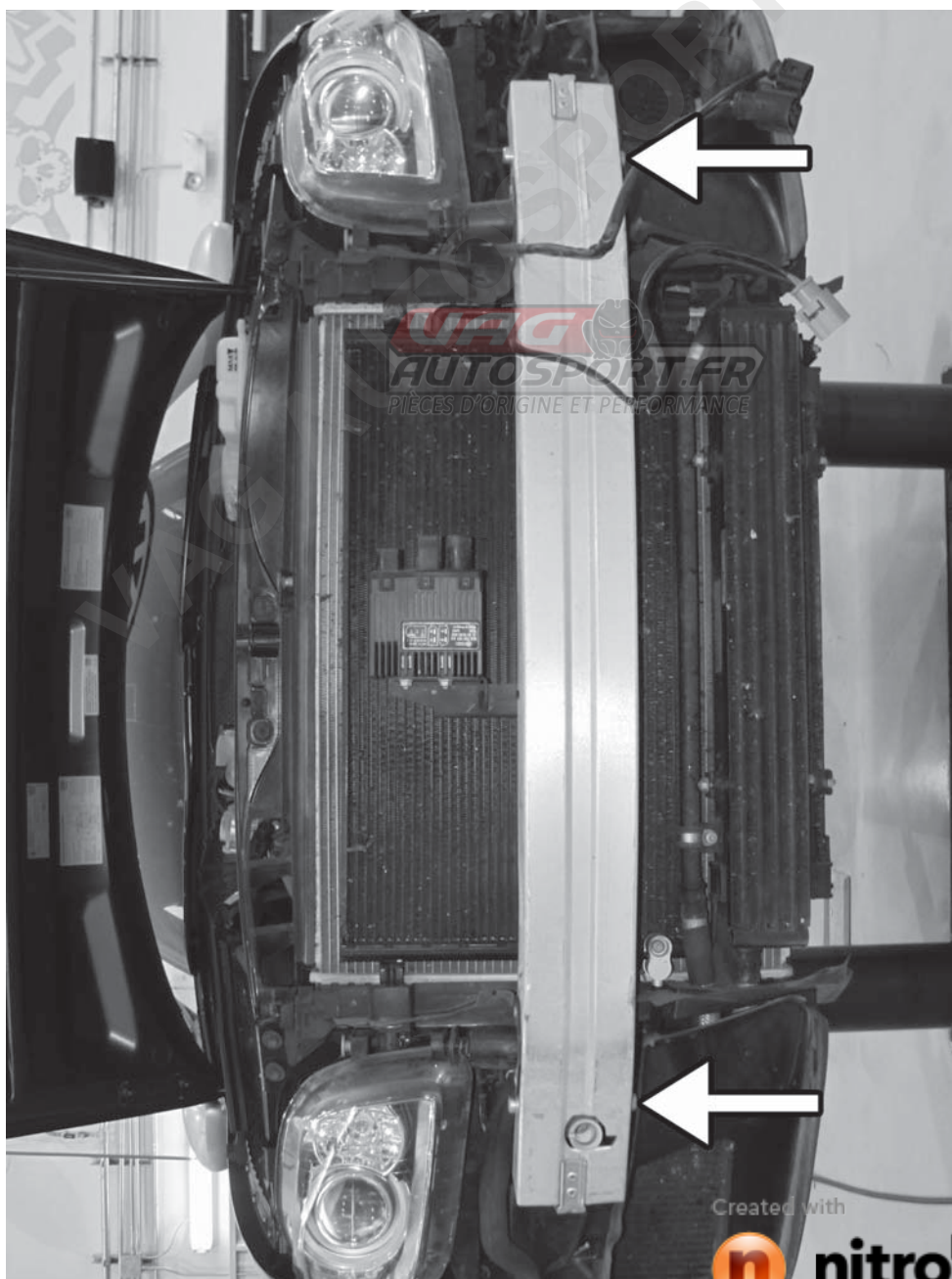

APR, LLC
4800 US HWY 280 West Opelika Alabama 36801

Created with



nitroPDF[®]

professional

download the free trial online at nitropdf.com/professional

14) Remove the four (two on each side) T30 Torx Screws that hold the radiator air ducts to each side radiator. Remove the ducting from the car.

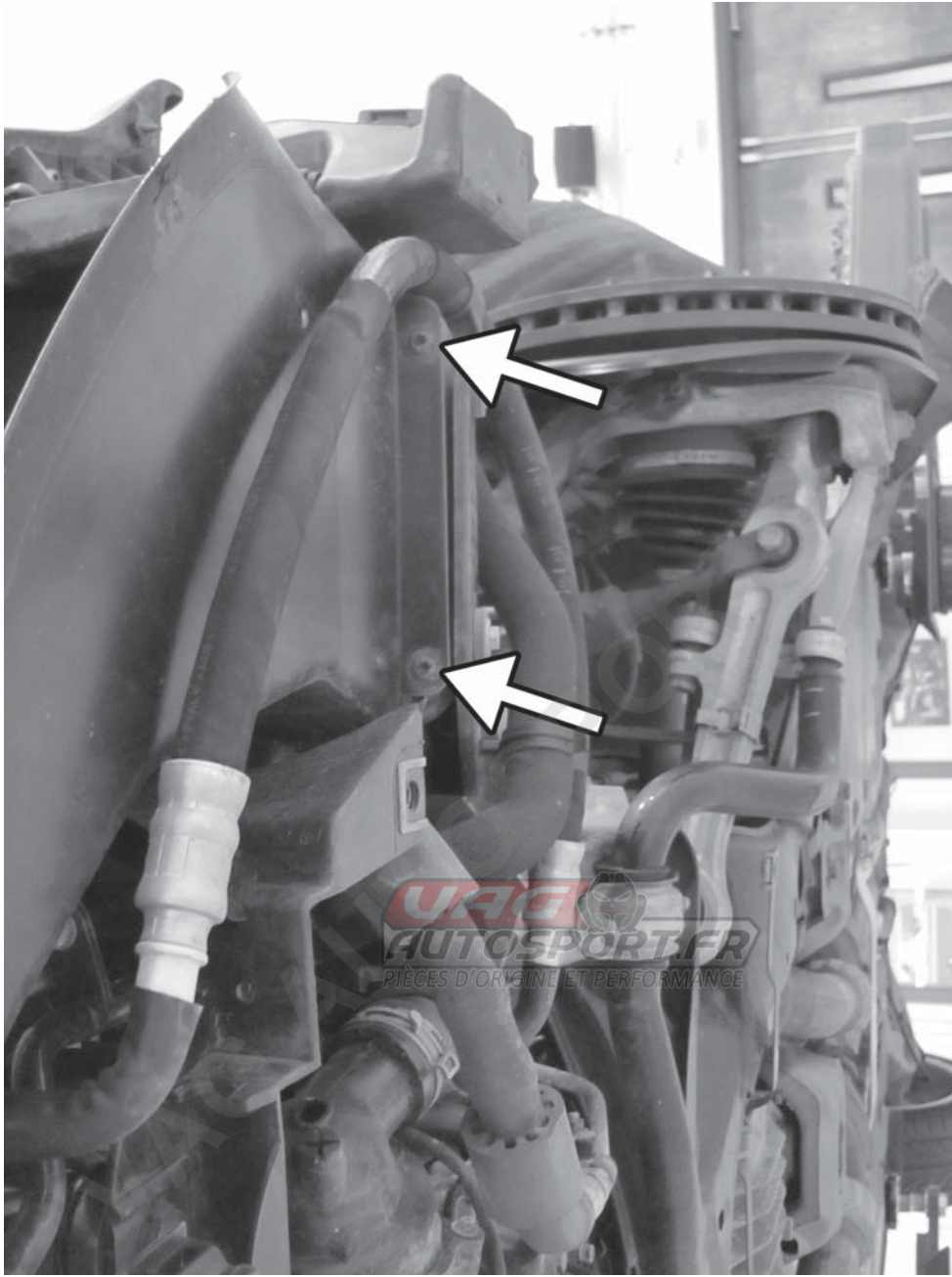

Created with



nitro PDF[®]

professional

download the free trial online at nitropdf.com/professional

APR, LLC
4800 US HWY 280 West Opelika Alabama 36801

15) Remove the two (one from either side) 13MM screws from the lower outer bumper shock mounting bracket.

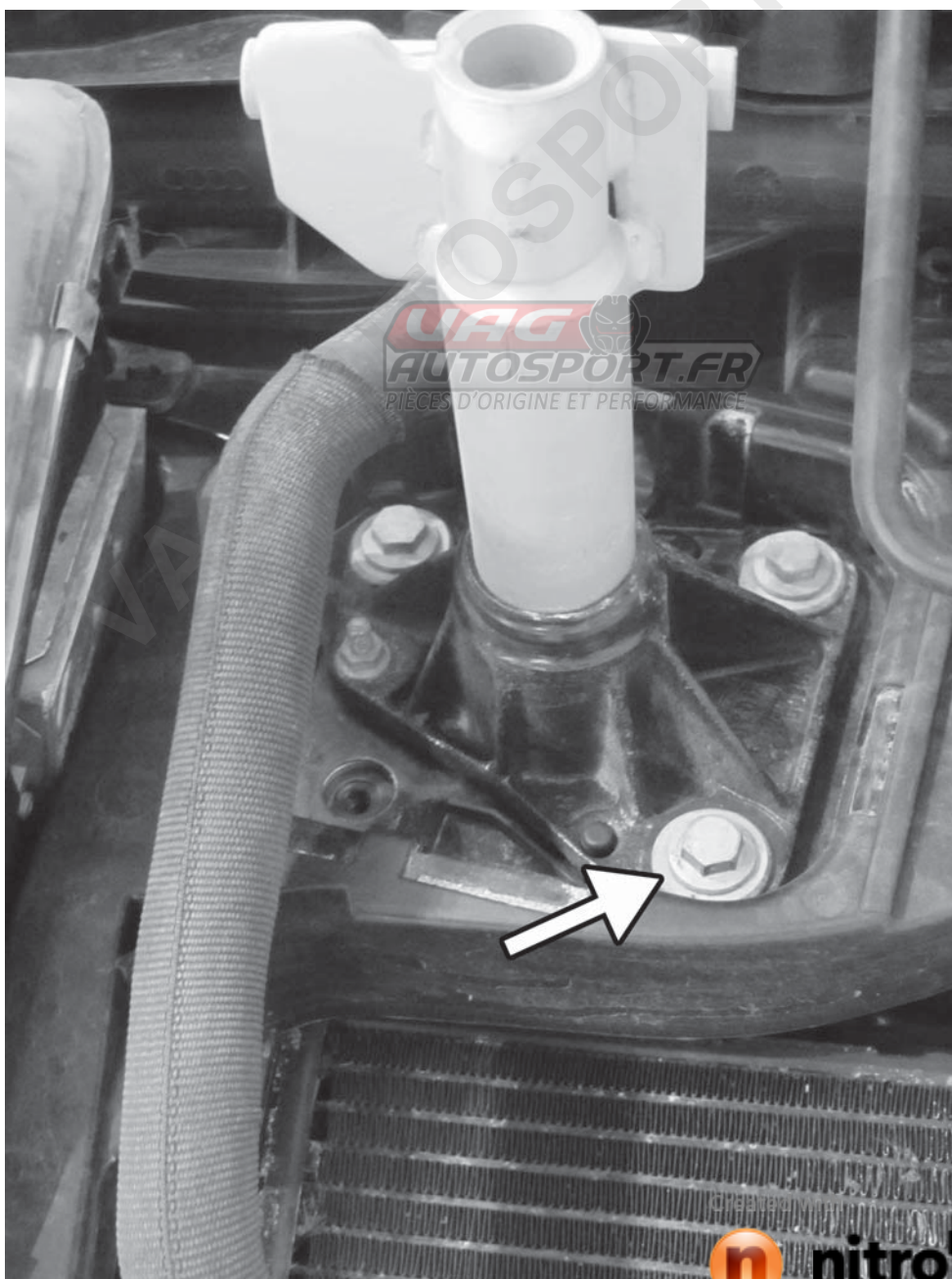

APR, LLC
Alabama 36801
4800 US HWY 280 West Opelika

16) In place of the bolt that was removed, install the two supplied 200mm bolts. The radiator core support will sit on these bolts when it is slid forward.

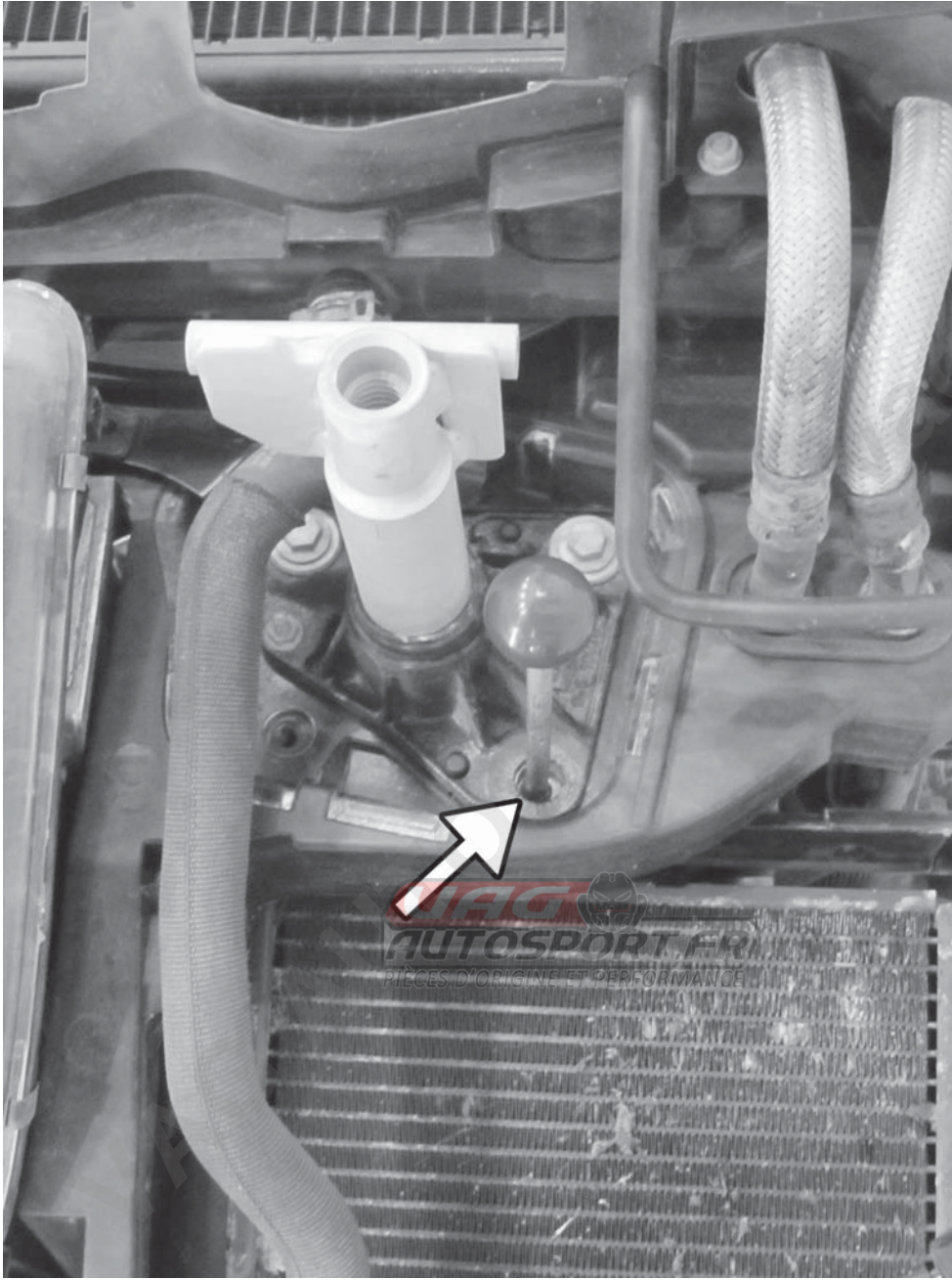

Created with



nitroPDF[®]

professional

download the free trial online at nitropdf.com/professional

APR, LLC
4800 US HWY 280 West Opelika Alabama 36801

17) Remove the four (two on each side) T30 Torx screws that connect the upper portion of the radiator core support to the front fender.

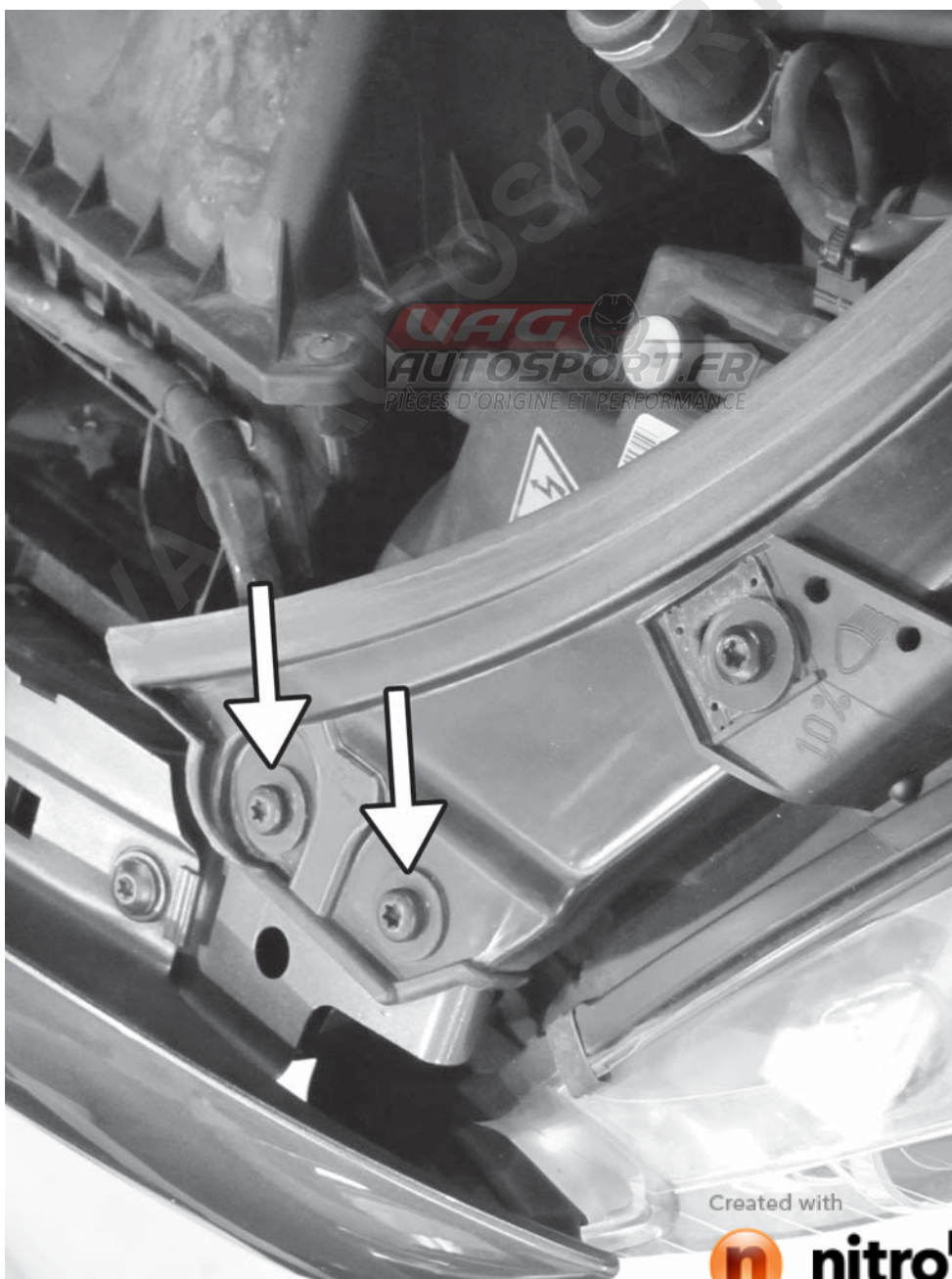

APR, LLC
Alabama 36801
4800 US HWY 280 West Opelika

18) Remove the two (one on each side) T30 Torx screws that connect the side of the radiator core support with the fender of the car.

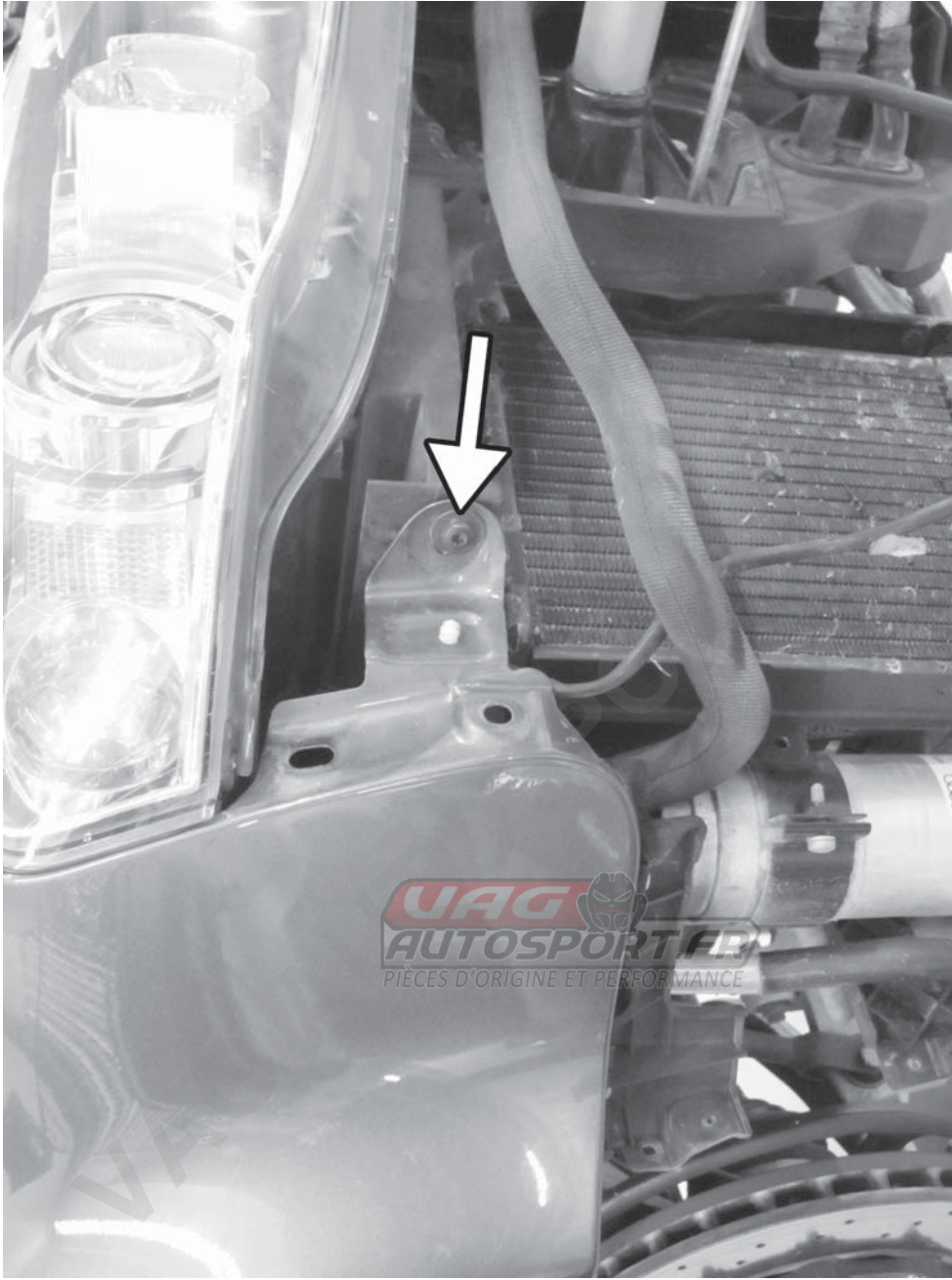

Created with



nitro PDF[®]

professional

download the free trial online at nitropdf.com/professional

APR, LLC
4800 US HWY 280 West Opelika Alabama 36801

19) On the left side radiator, remove the 10MM screw that holds the side radiator mounting tab to the radiator core support.

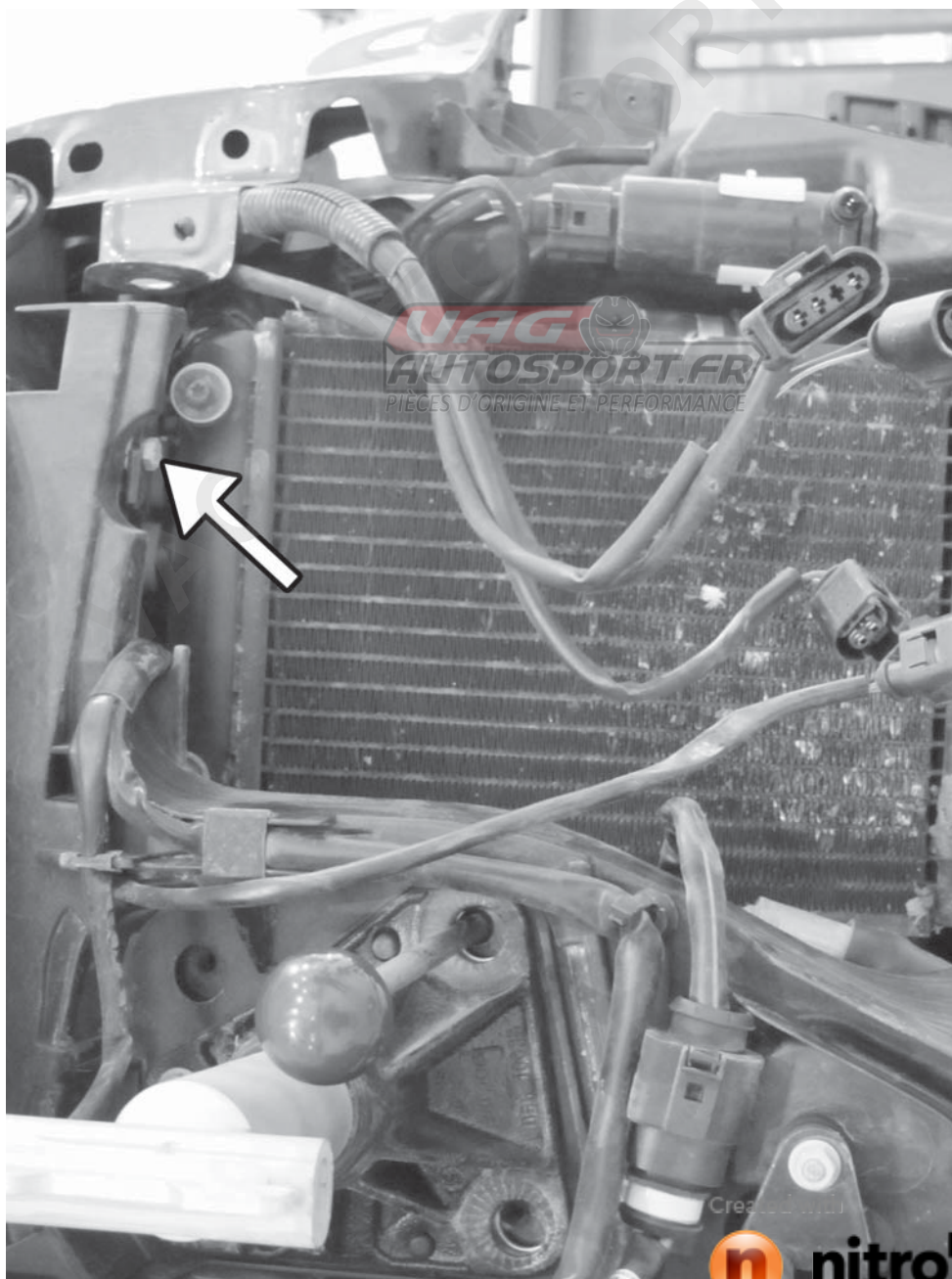

APR, LLC
Alabama 36801
4800 US HWY 280 West Opelika

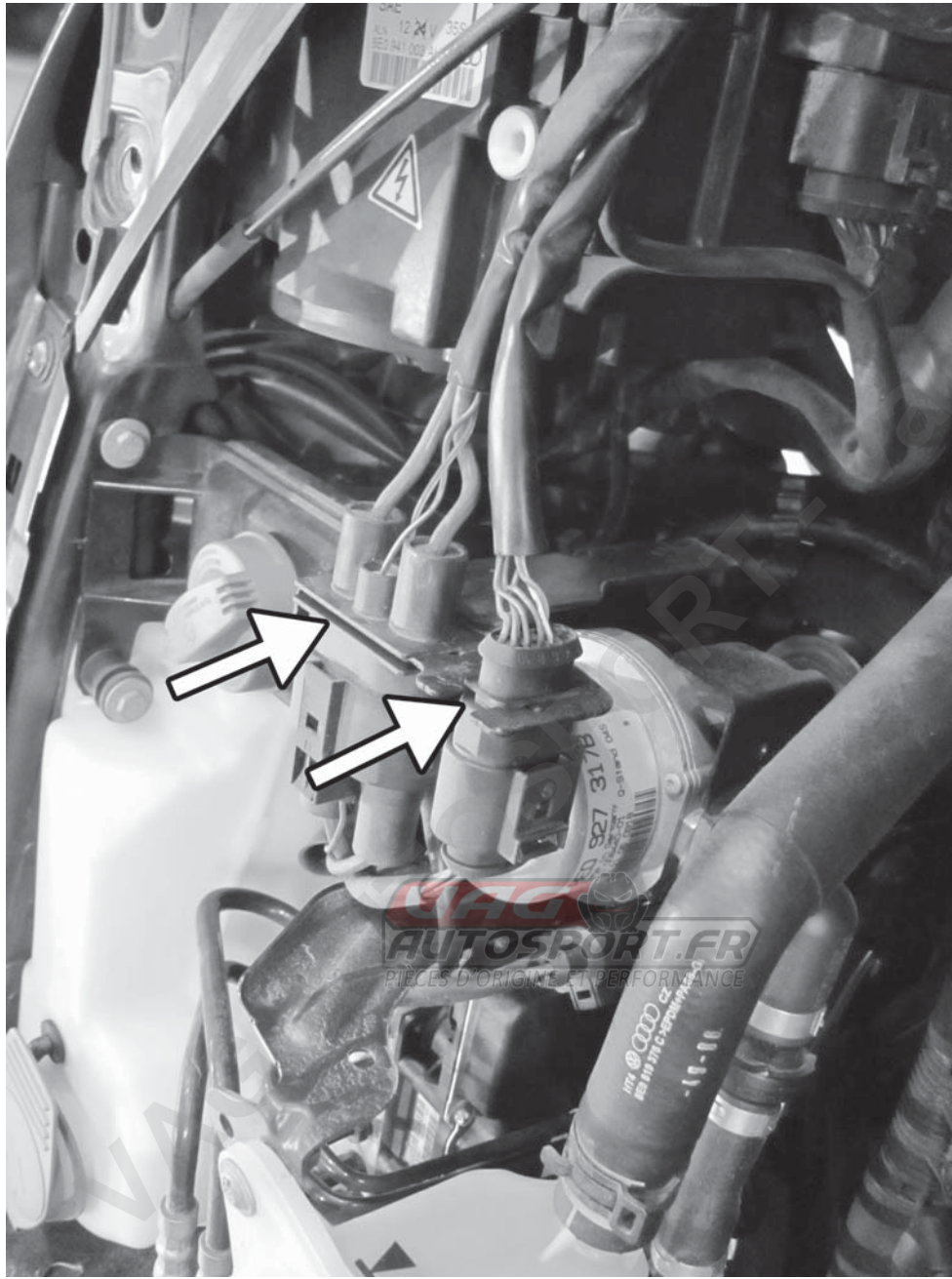

20) On the left side behind the headlight, unclip and disconnect the two electrical connectors to the radiator fans. The radiator core support can now be carefully pulled forward approximately six inches in order to access the front of the engine.

Created with



nitro PDF[®]

professional

download the free trial online at nitropdf.com/professional

APR, LLC
4800 US HWY 280 West Opelika Alabama 36801

21) Loosen the cap to the coolant expansion tank.

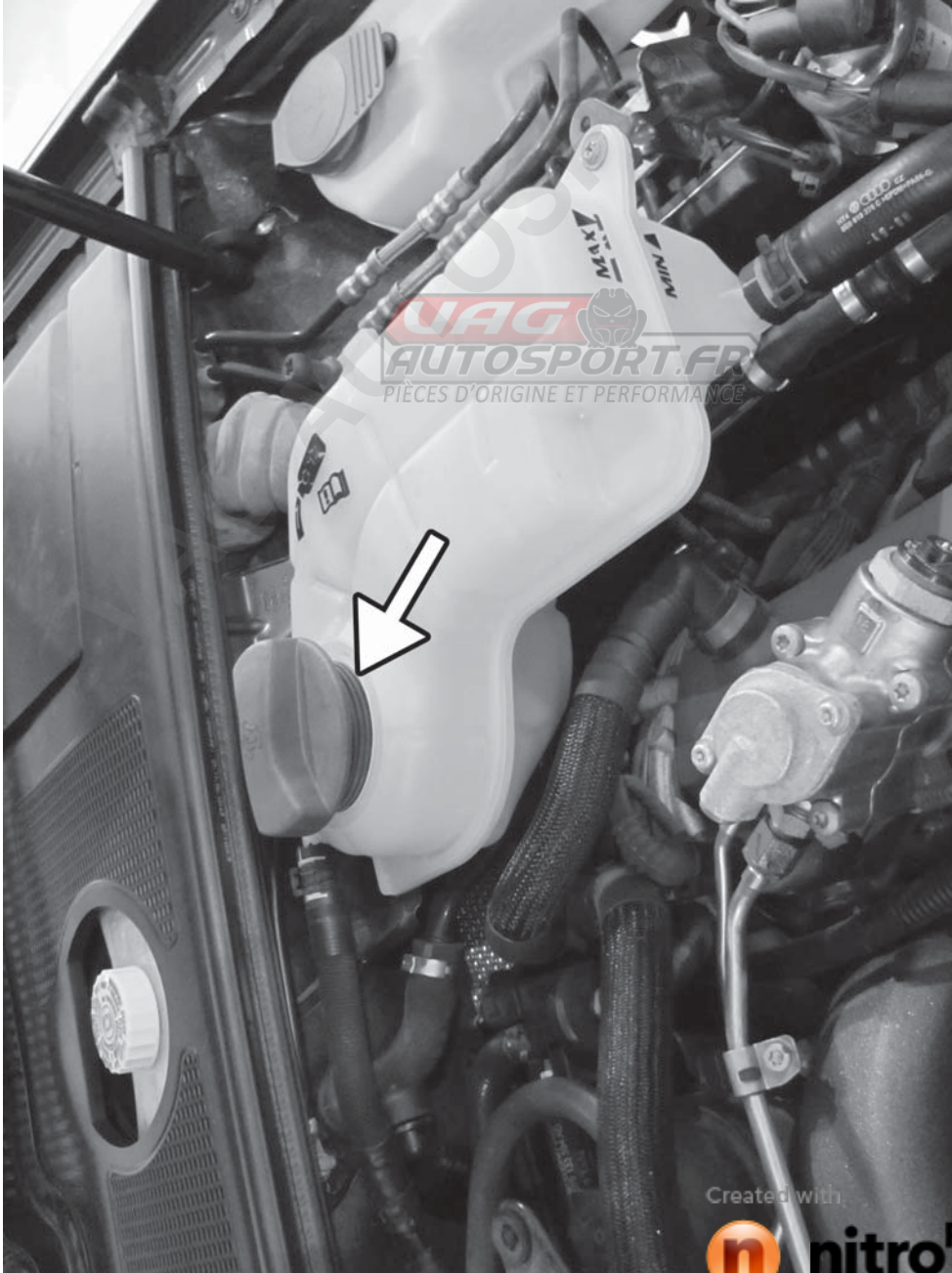

APR, LLC
Alabama 36801
4800 US HWY 280 West Opelika

22) With a large drain pan, loosen and remove the 5MM allen drain plug for the coolant system.

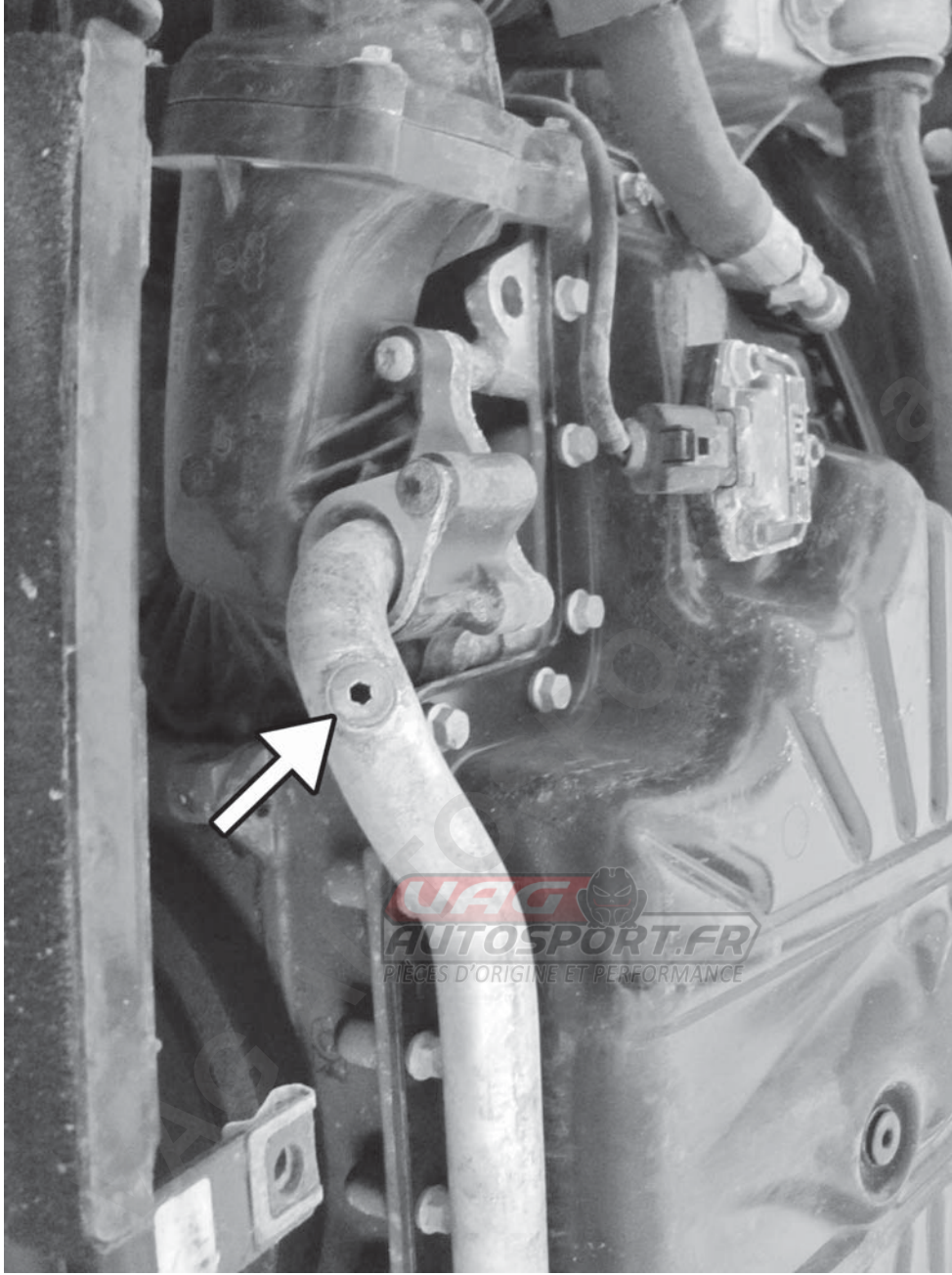

Created with



nitro PDF[®]

professional

download the free trial online at nitropdf.com/professional

APR, LLC
4800 US HWY 280 West Opelika Alabama 36801

23) Remove the front engine cover from the car.

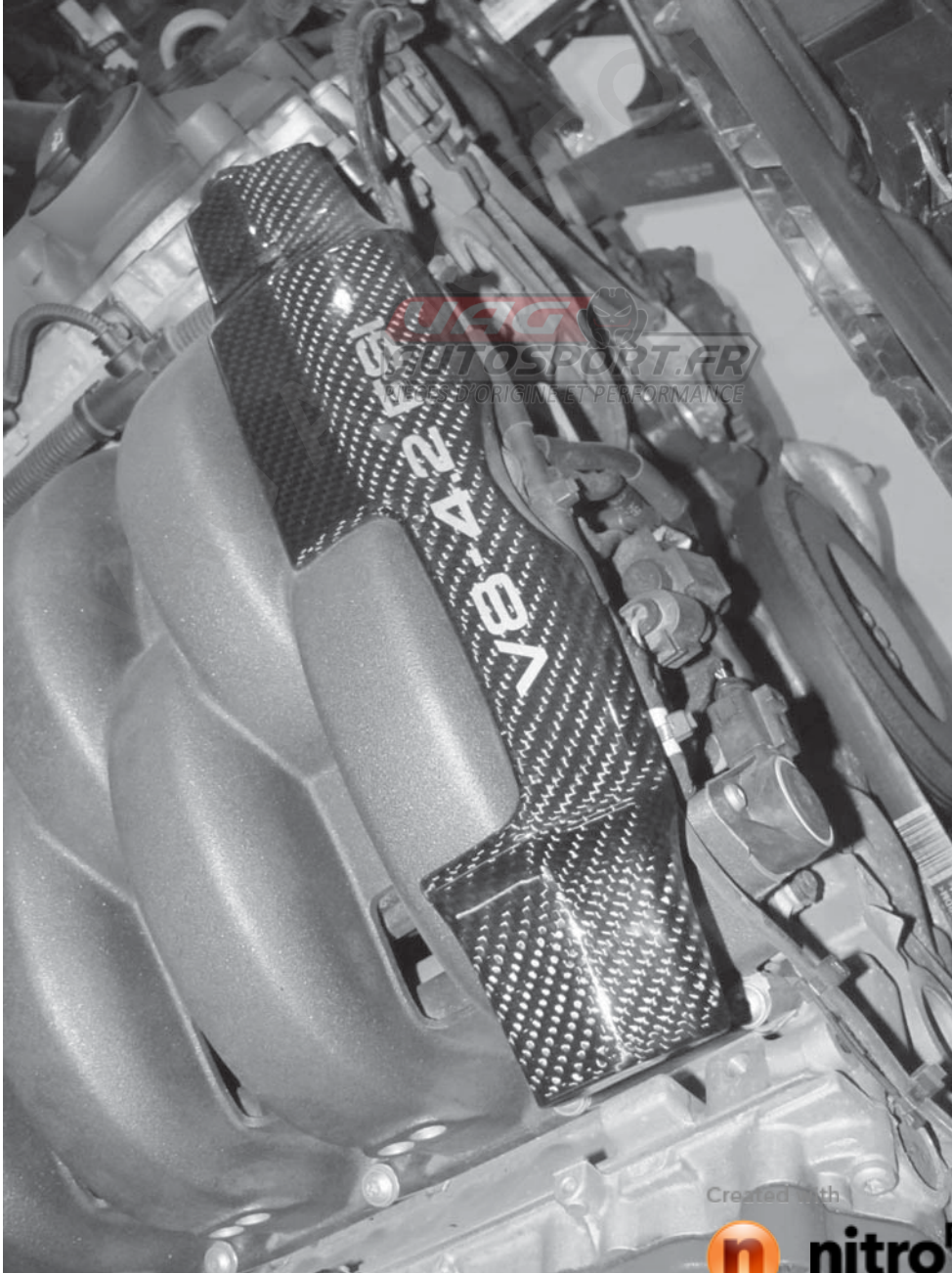

APR, LLC
4800 US HWY 280 West Opelika Alabama 36801

Created with



nitro PDF

professional

download the free trial online at nitropdf.com/professional

24) Remove the rear engine cover from the engine.



Created with



nitro PDF[®]

professional

download the free trial online at nitropdf.com/professional

APR, LLC
4800 US HWY 280 West Opelika Alabama 36801

g-autosport

25) Disconnect the two coolant lines that connect to the coolant expansion tank. Also remove the phillips screw that holds the front of the tank.

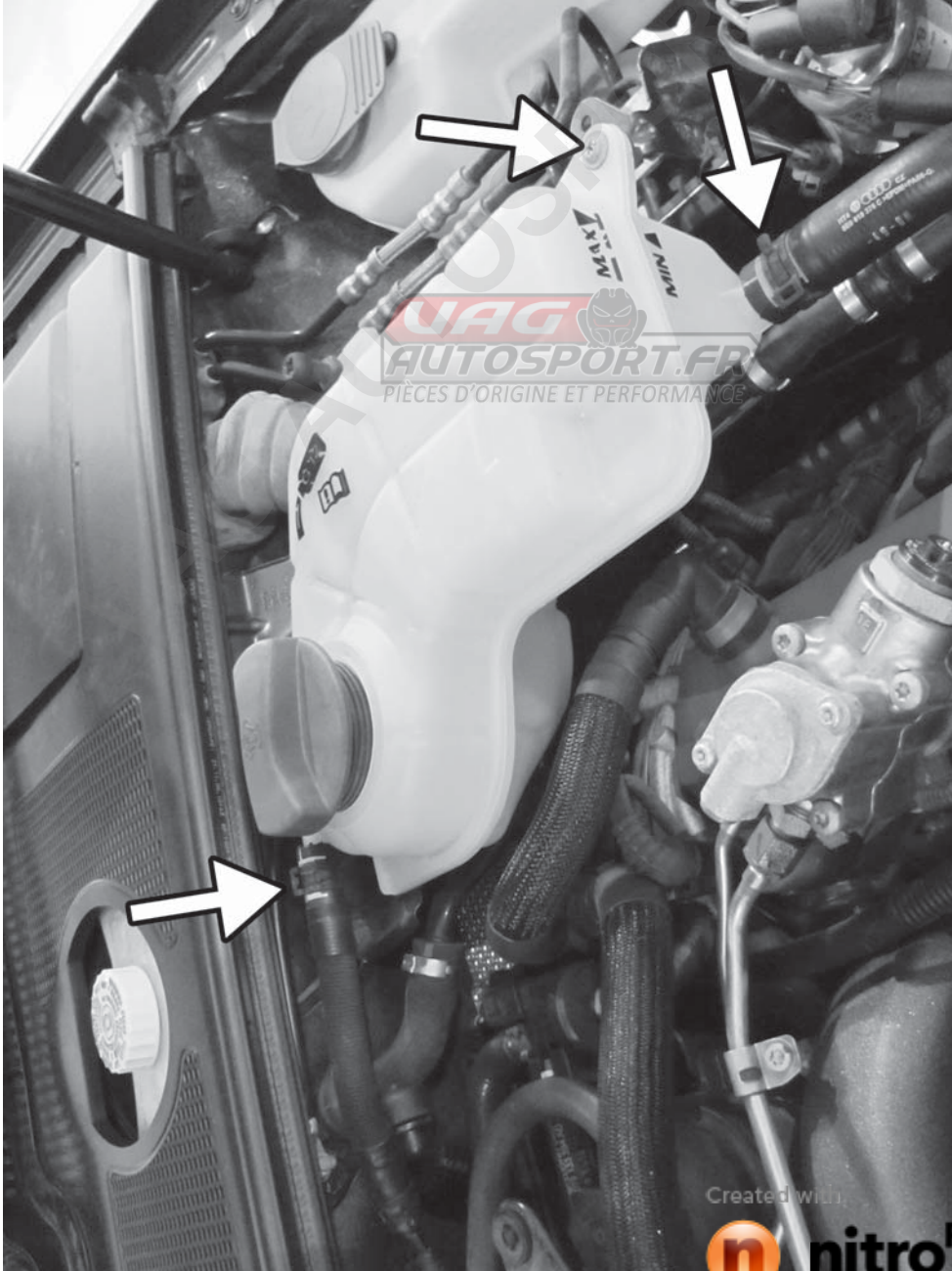

APR, LLC
Alabama 36801
4800 US HWY 280 West Opelika

26) Remove the tank from the car, remembering to disconnect the level sensor from the bottom of the tank.



Created with



nitro PDF[®]

professional

download the free trial online at nitropdf.com/professional

APR, LLC
4800 US HWY 280 West Opelika Alabama 36801

27) Loosen the two hose clamps on the MAF throttle body hose. Disconnect the top vacuum hose by cutting the hose clamp from the throttle body hose. Disconnect the crankcase vent hose from the throttle body hose as well. Remove the hose from the car.

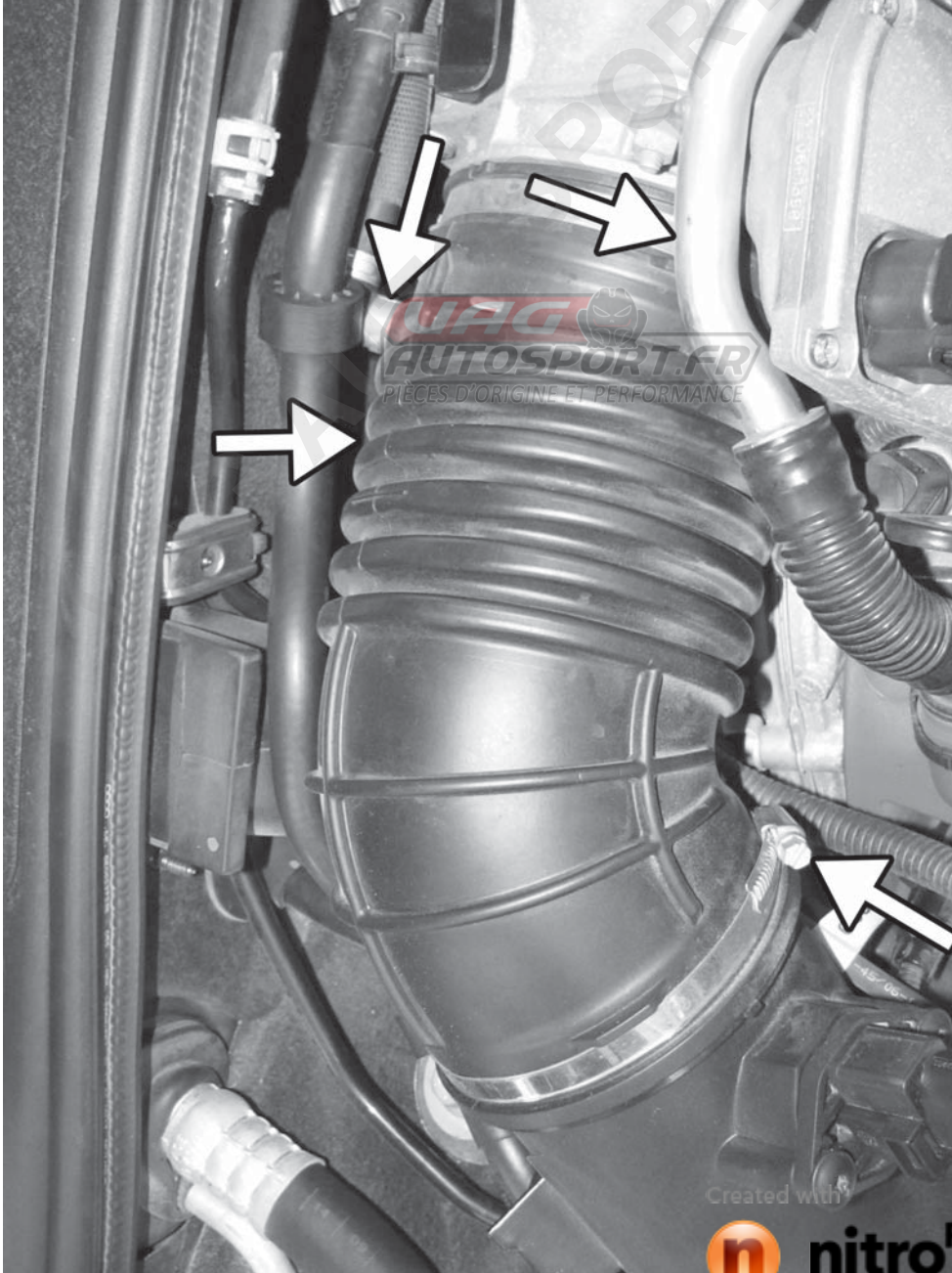

APR, LLC
Alabama 36801
4800 US HWY 280 West Opelika

28) Remove the two 10MM screws from the rear engine cover support bracket. Also remove the clip that holds the hose on the back of the bracket.

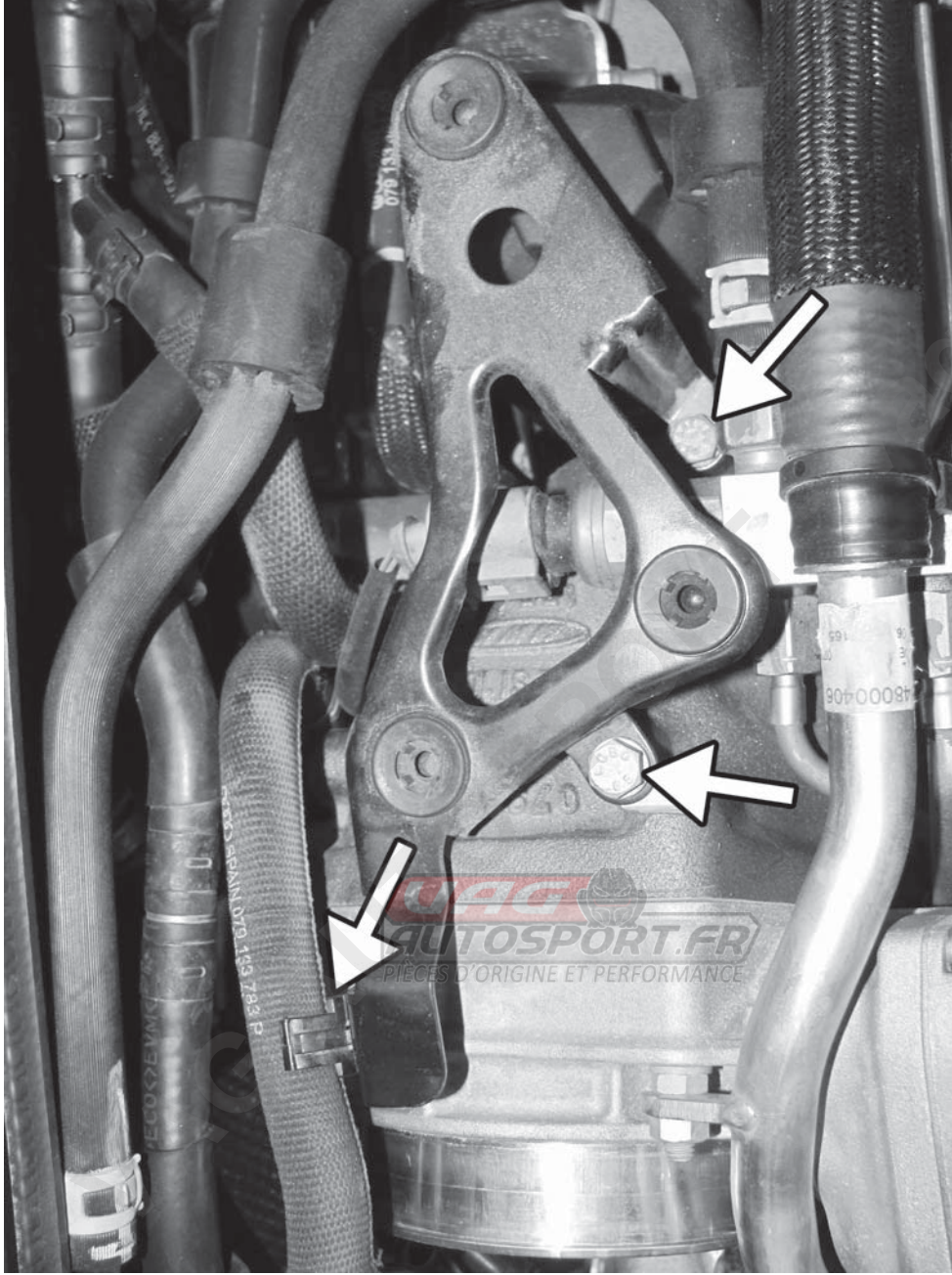

Created with

 **nitro** PDF[®] professional

download the free trial online at nitropdf.com/professional

APR, LLC
4800 US HWY 280 West Opelika Alabama 36801

29) Remove the upper right 10MM hex nut from the throttle body. Cut the cable tie that connects the PCV hose to the factory fuel distribution block. Disconnect the PCV hose assembly that connects to each valve cover and the oil separator and remove the assembly from the car.

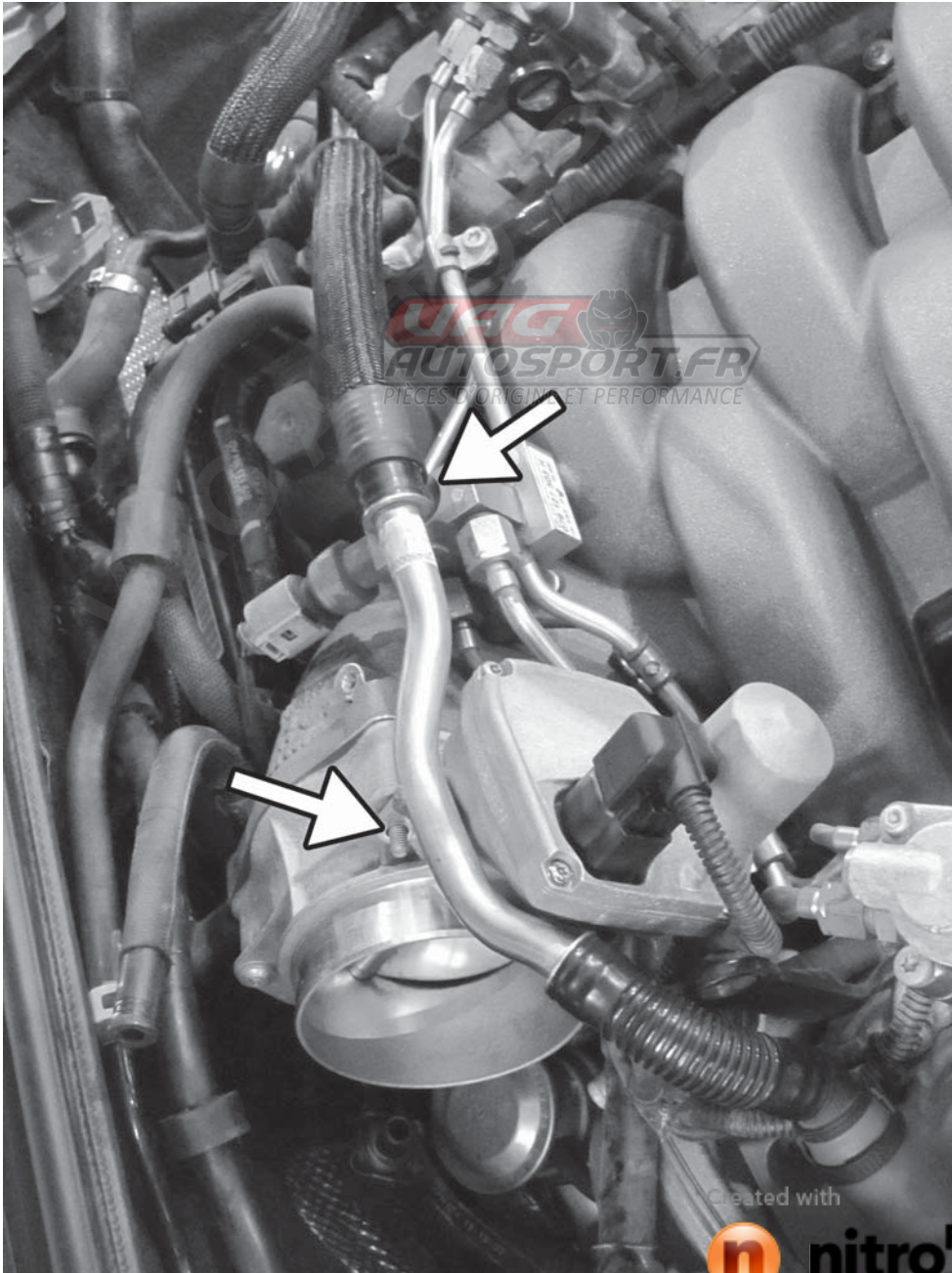

APR, LLC
Alabama 36801
4800 US HWY 280 West Opelika

30) Disconnect the electrical connector from the throttle body and remove the remaining three T30 Torx screws on the throttle body. Remove the throttle body and throttle body gasket from the car.

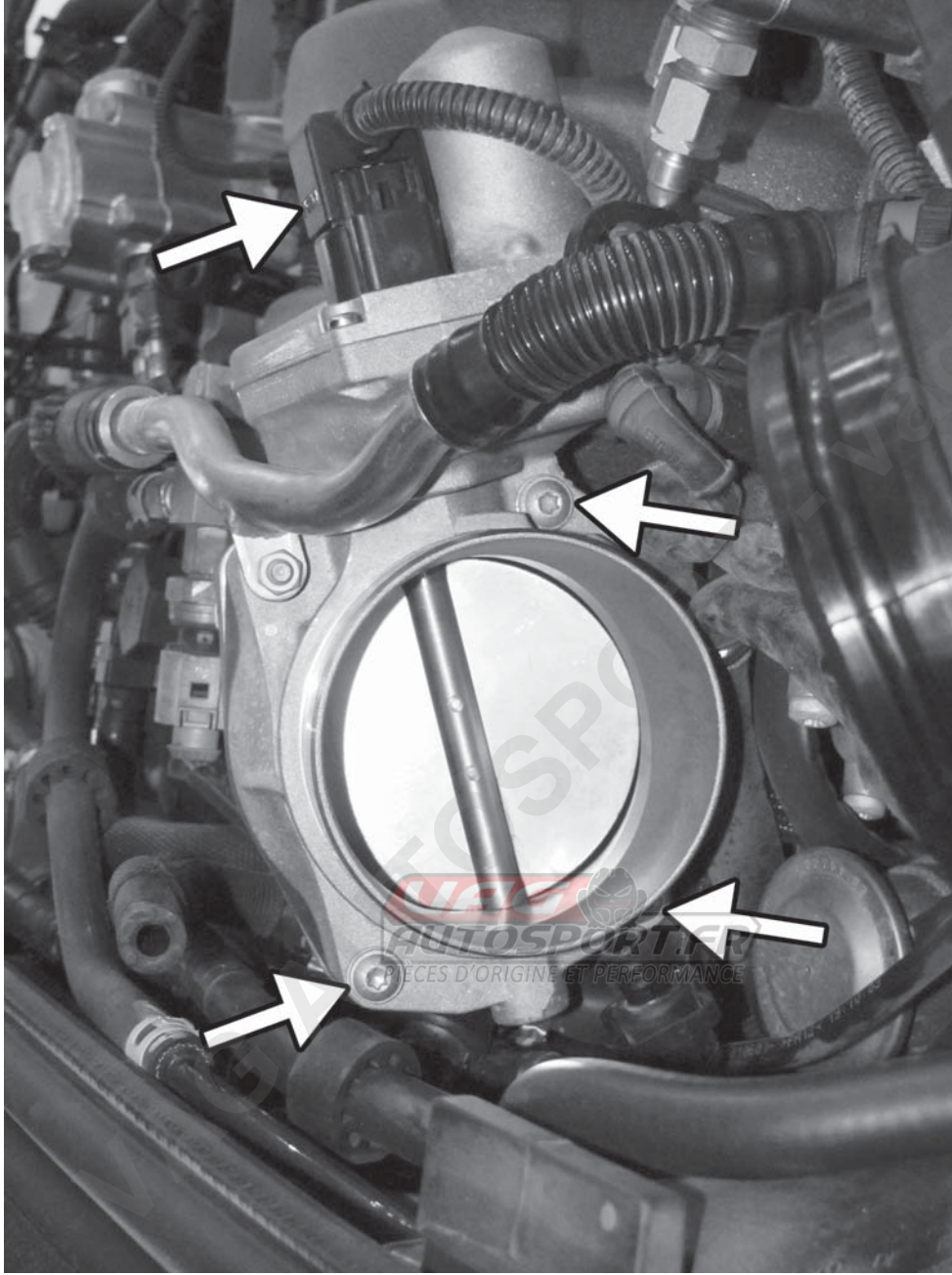

Created with



nitro PDF[®]

professional

download the free trial online at nitropdf.com/professional

APR, LLC
4800 US HWY 280 West Opelika Alabama 36801

31) Disconnect the electrical connector to the low pressure fuel sensor located on the back of the high pressure fuel distribution block.

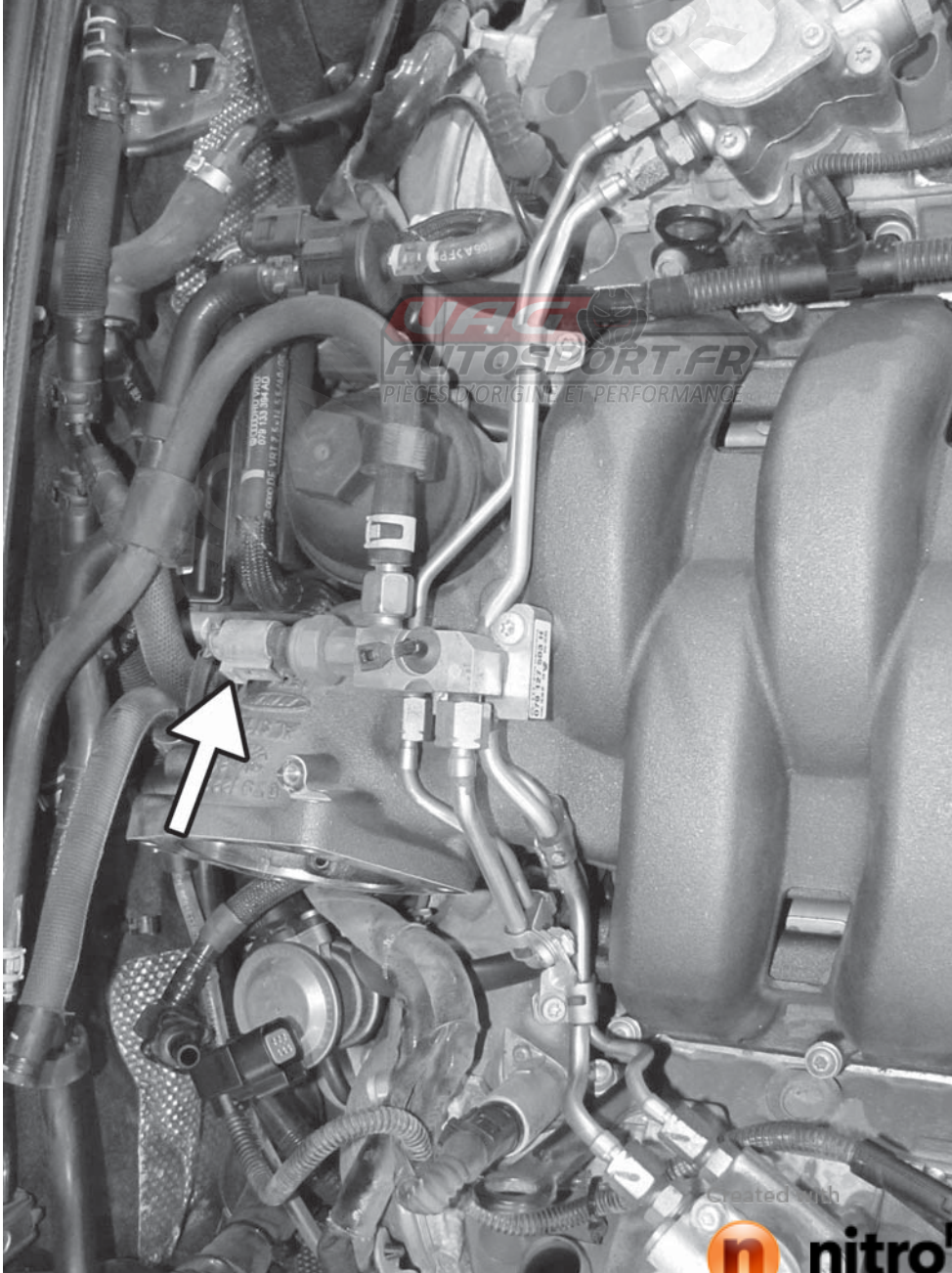

APR, LLC
Alabama 36801
4800 US HWY 280 West Opelika

32) Using a 17MM flare wrench, loosen and remove the low pressure fuel supply line to the fuel distribution block. A rag will be needed as residual fuel will leak from the line.

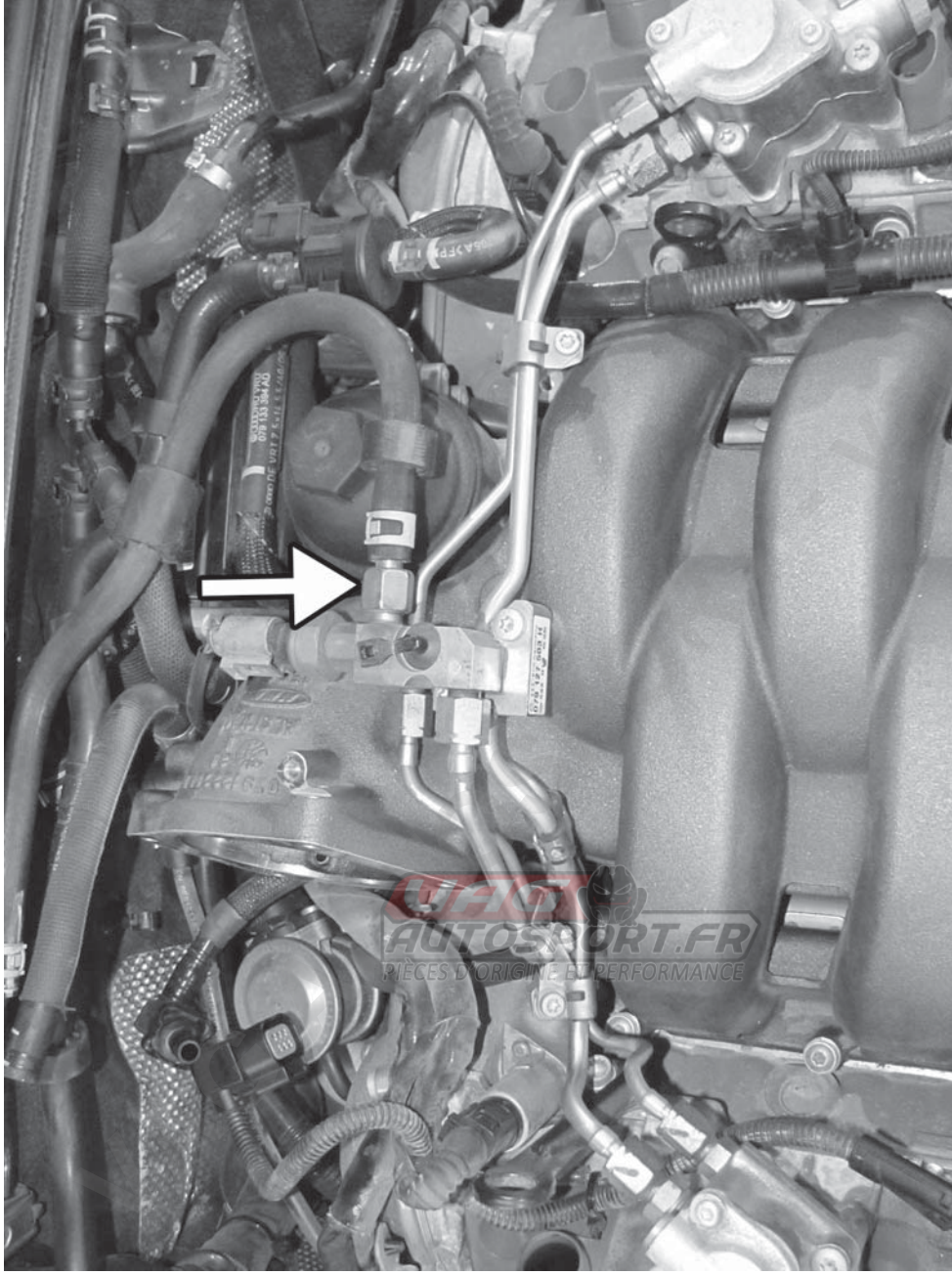

Created with



nitro PDF[®]

professional

download the free trial online at nitropdf.com/professional

APR, LLC
4800 US HWY 280 West Opelika Alabama 36801

33) Using both 17MM and 14MM flare wrenches, loosen all the flare wrenches, loosen all the connections on the fuel distribution block, both at the High Pressure Fuel Pumps (HPFP) and on the distribution block as well.

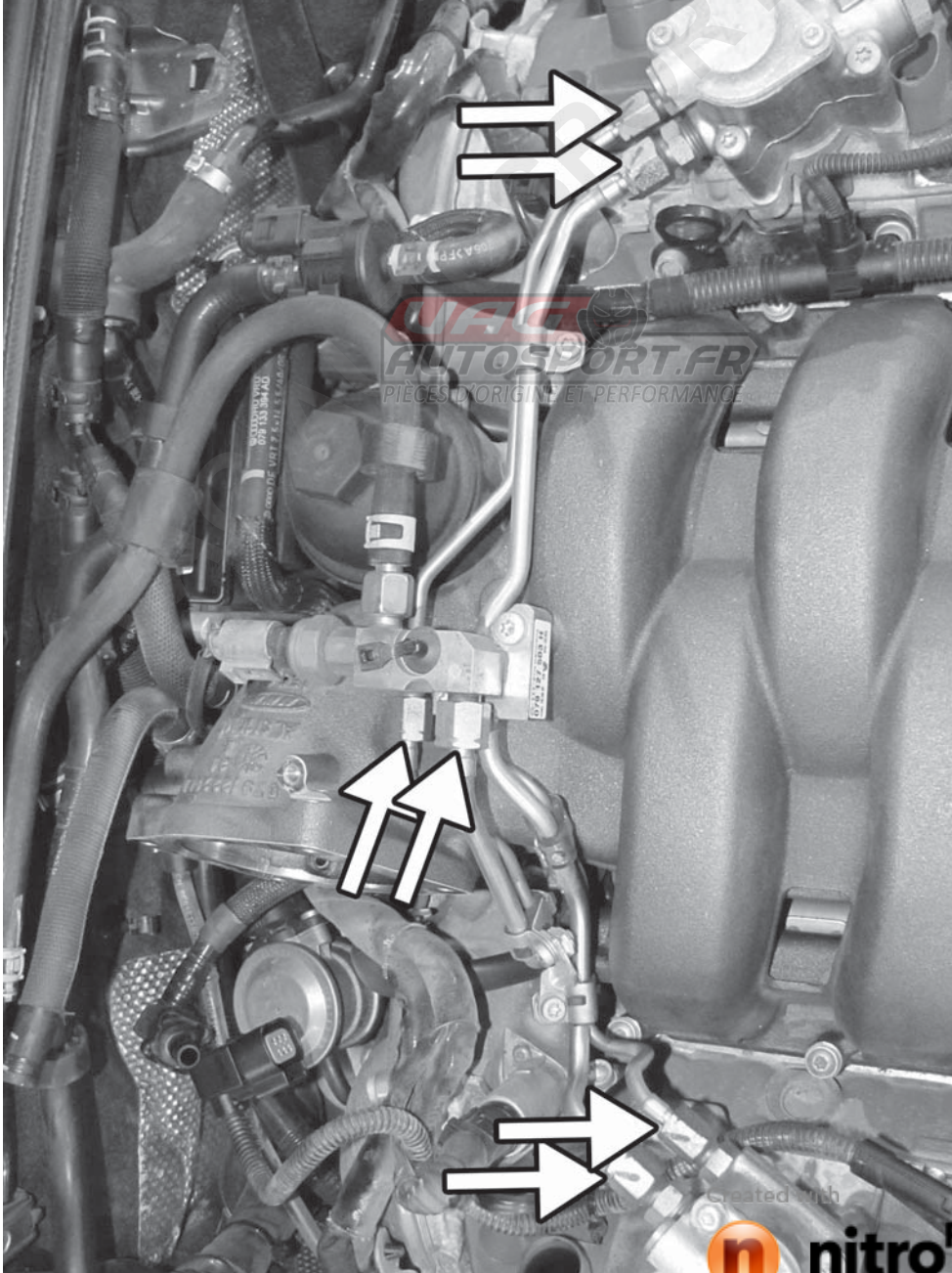

APR, LLC
4800 US HWY 280 West Opelika Alabama 36801

34) Remove the two T30 bolts from the fuel line brackets as well as the T30 bolt that holds the bracket to the intake manifold.

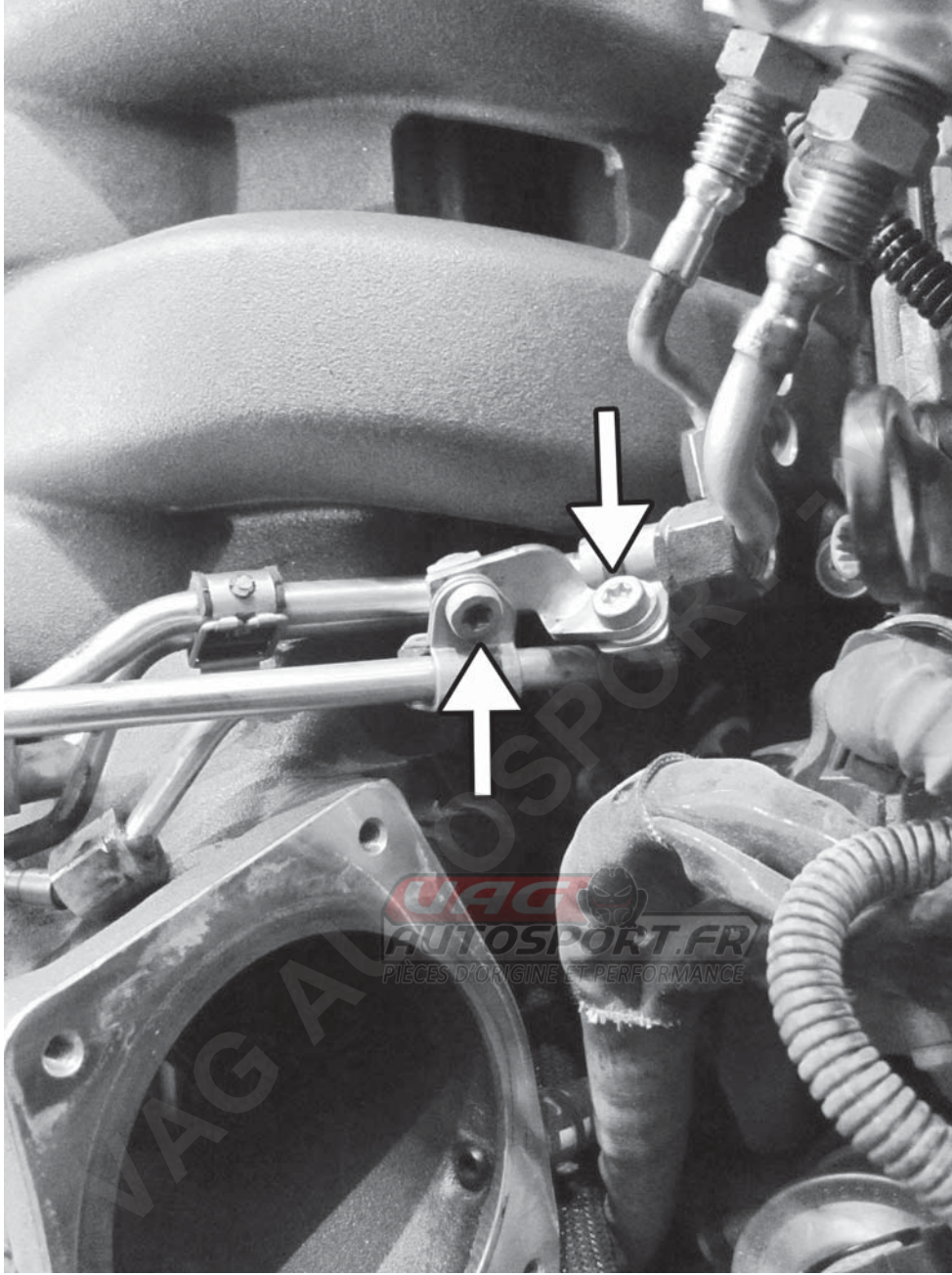

Created with



nitro PDF[®]

professional

download the free trial online at nitropdf.com/professional

APR, LLC
4800 US HWY 280 West Opelika Alabama 36801

35) Remove the two T30 torx bolts that hold the fuel distribution block to the intake manifold. Carefully remove the high pressure fuel line assembly from the car without bending the remaining fuel lines.

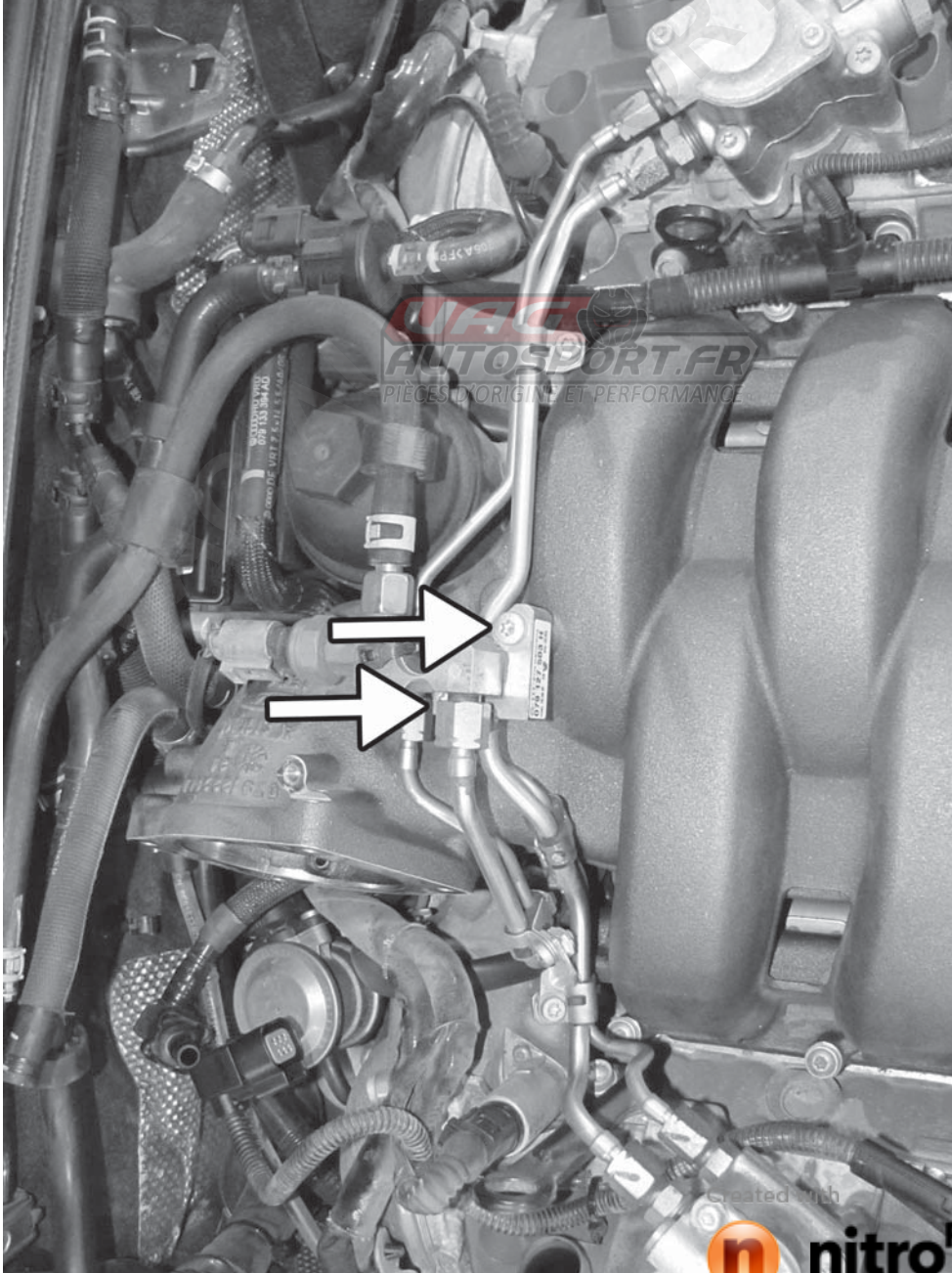

APR, LLC
4800 US HWY 280 West Opelika Alabama 36801

36) Disconnect the electrical connector to the N80 valve. Remove the hose clamps and vacuum lines off from either side of the N80 valve.

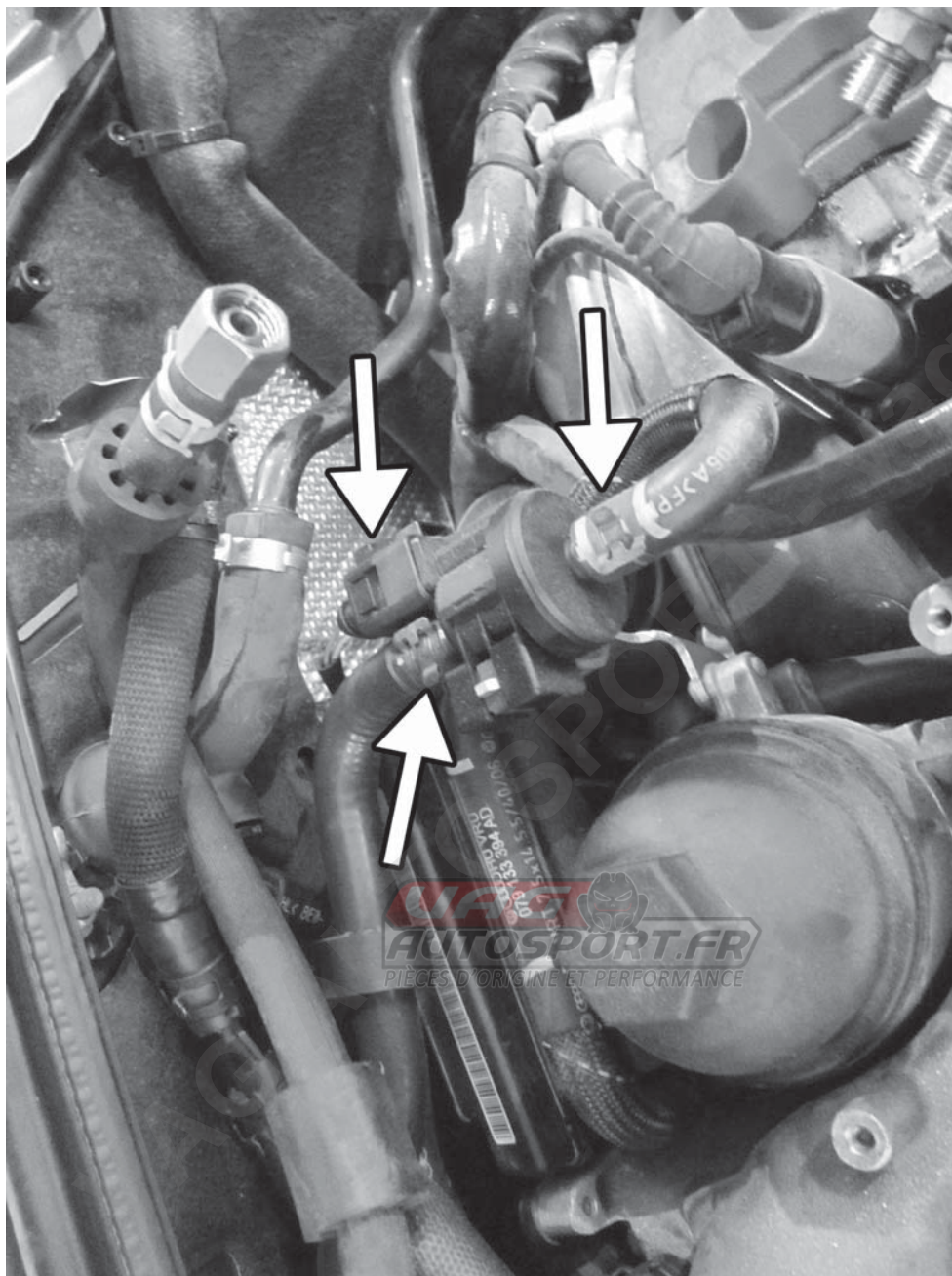

Created with

 **nitro** PDF[®] professional

download the free trial online at nitropdf.com/professional

APR, LLC
4800 US HWY 280 West Opelika Alabama 36801

37) Remove the hose clamp and remove the vacuum line from the other end of the N80 line where it connects next to the factory airbox. Remove the N80 valve and vacuum line from the car.

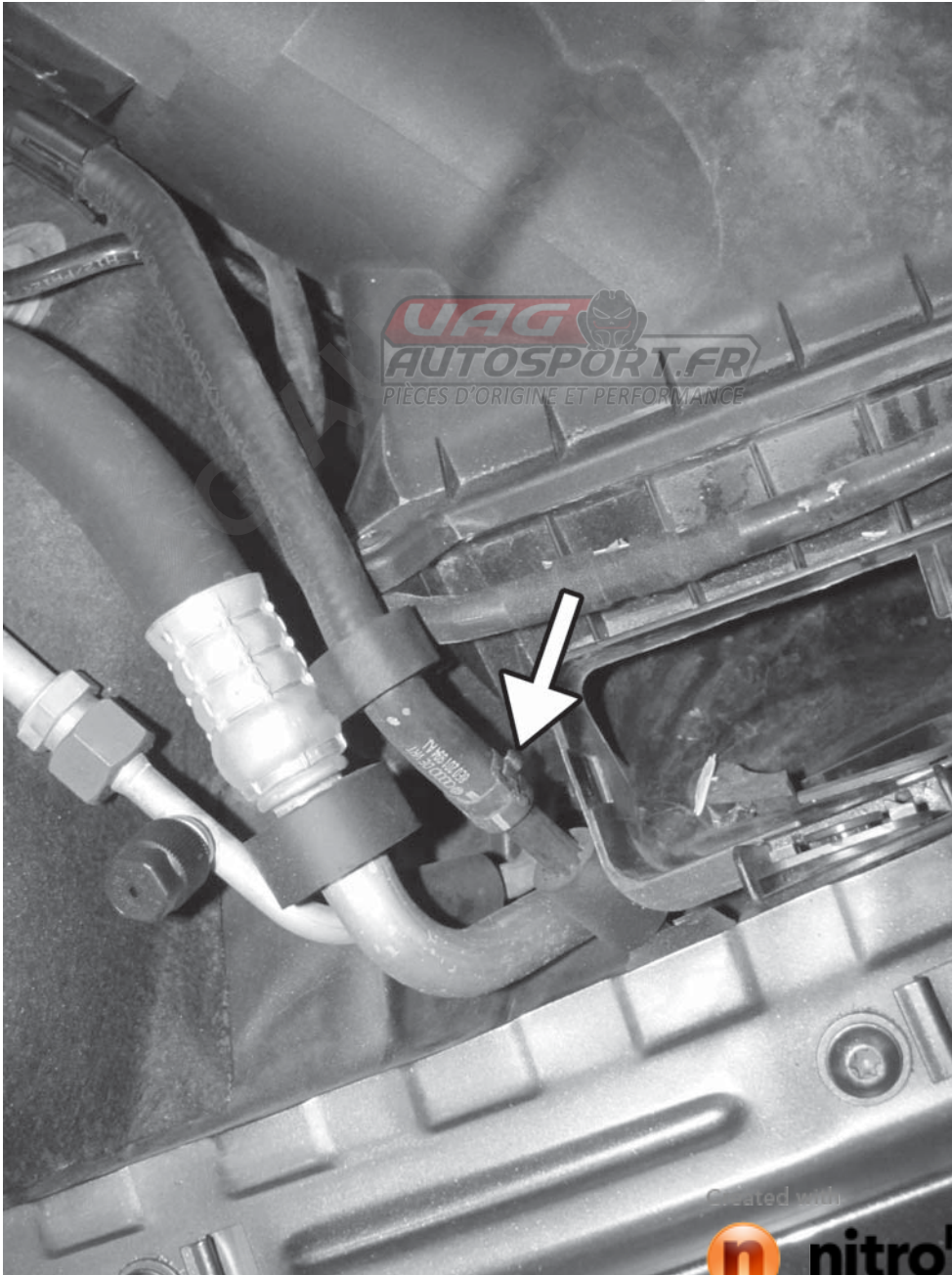

APR, LLC
Alabama 36801
4800 US HWY 280 West Opelika

38) Cut the three cable ties that connect the Intake Manifold Runner Control (IMRC) vacuum lines to the front engine cover bracket on the front of the engine. Remove the three 10MM screws that connect the bracket to the intake manifold and remove the bracket from the car.

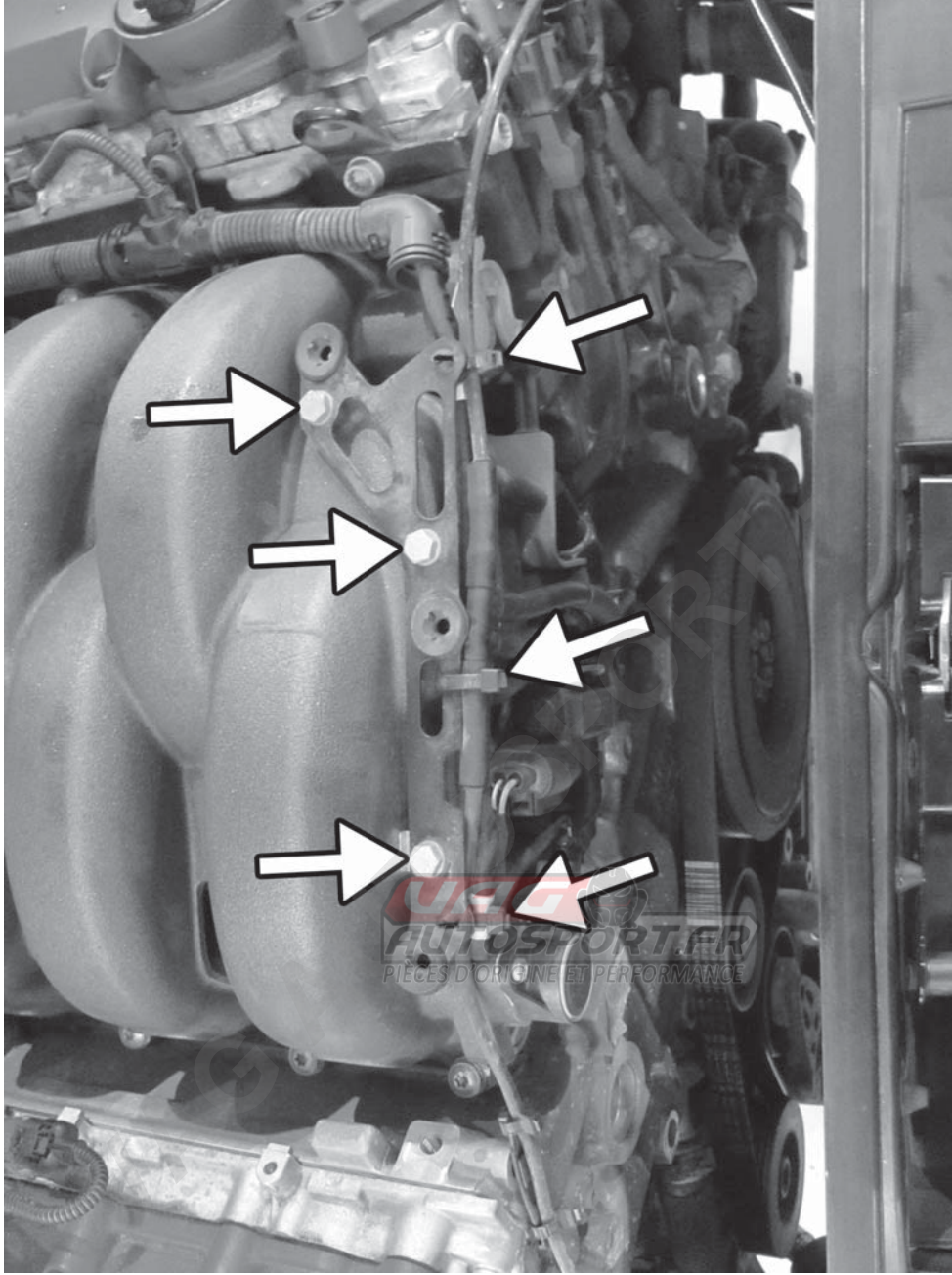

Created with



nitroPDF[®]

professional

download the free trial online at nitropdf.com/professional

APR, LLC
4800 US HWY 280 West Opelika Alabama 36801

39) Disconnect the electrical connector to the IMRC valve and IMRC sensor. Also disconnect the two electrical connectors to the two knock sensors (not shown) that are under the intake manifold.

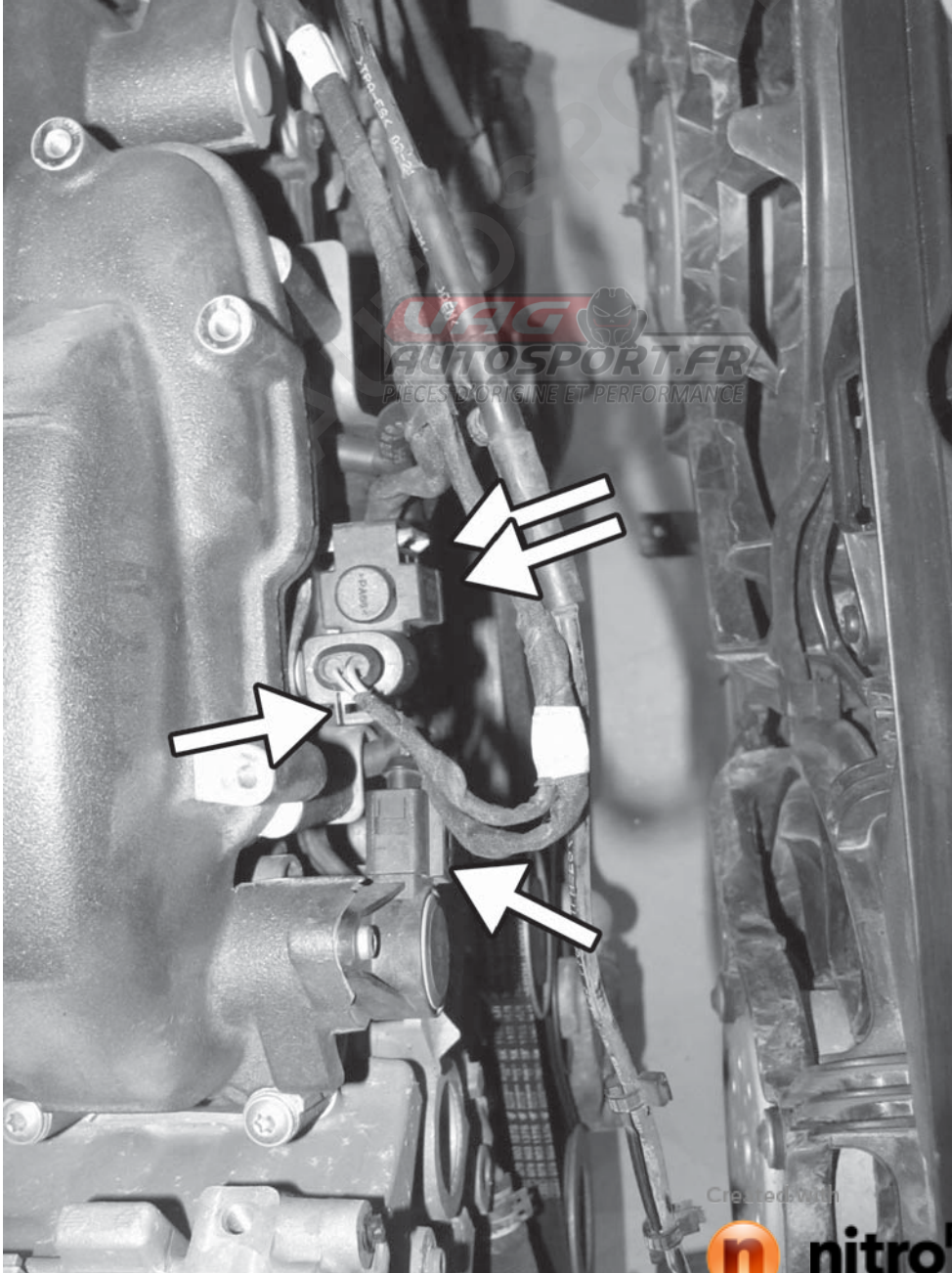

APR, LLC
Alabama 36801
4800 US HWY 280 West Opelika

40) Disconnect the vacuum lines from the double tee fitting to the front of the intake manifold at the tee fitting. Leave the tee fitting in the car for now.

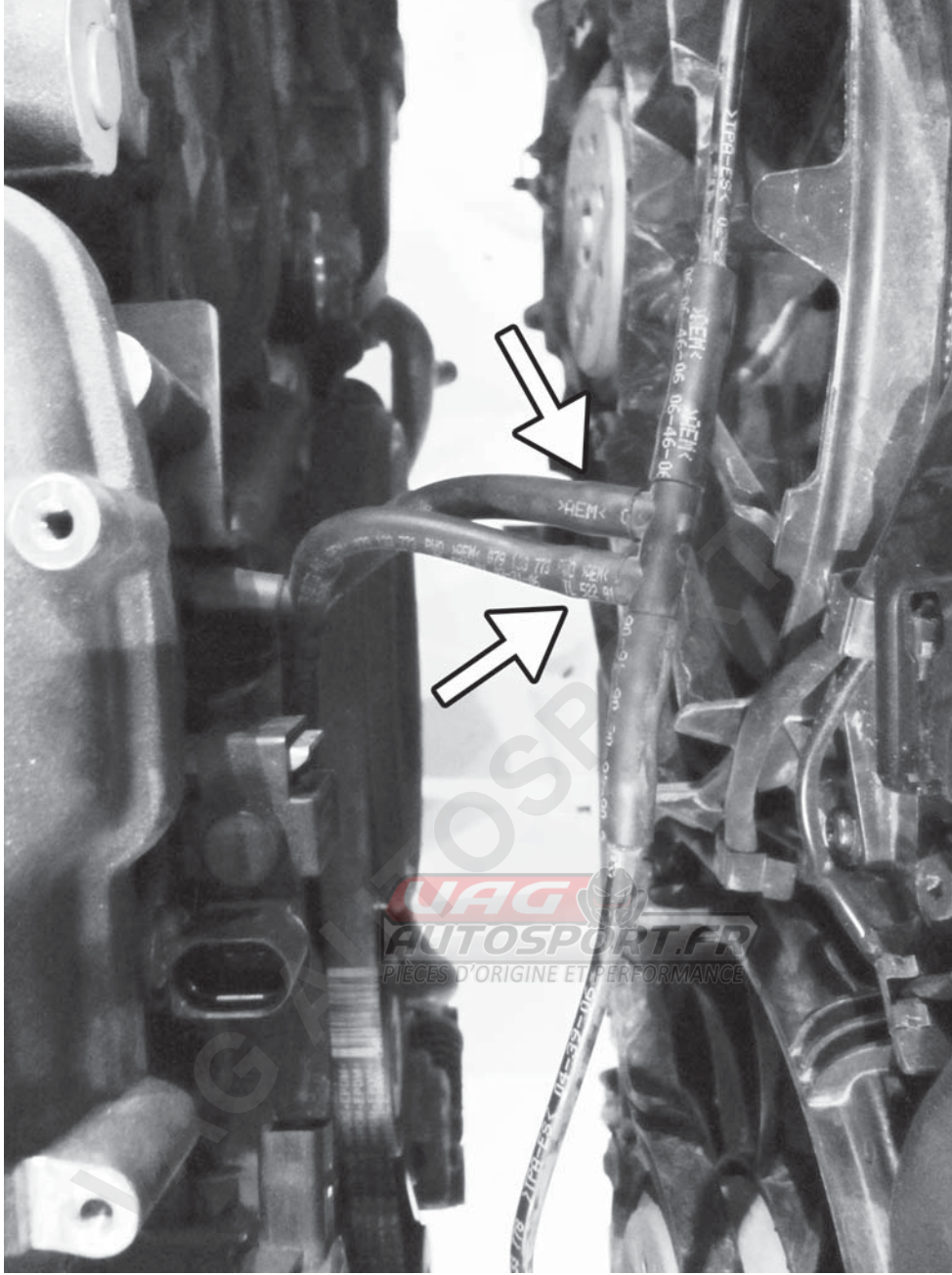

Created with



nitro PDF[®]

professional

download the free trial online at nitropdf.com/professional

APR, LLC
4800 US HWY 280 West Opelika Alabama 36801

41) Remove the one 10MM triple square screw from the right engine lifting eye and remove the bracket from the car.

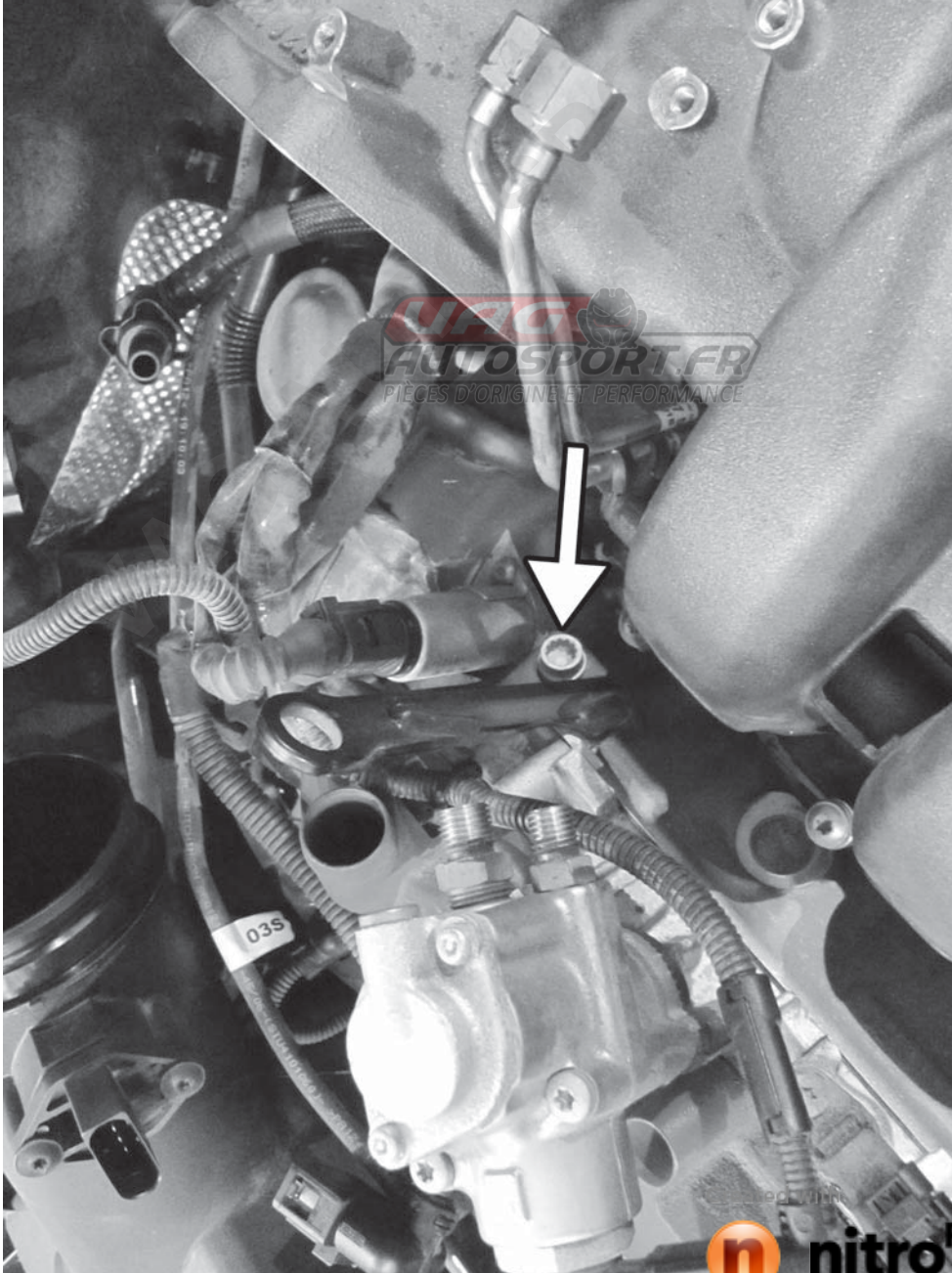

APR, LLC
Alabama 36801
4800 US HWY 280 West Opelika

42) Remove the two 10MM triple square screws from the left engine lifting eye and remove the bracket from the car.

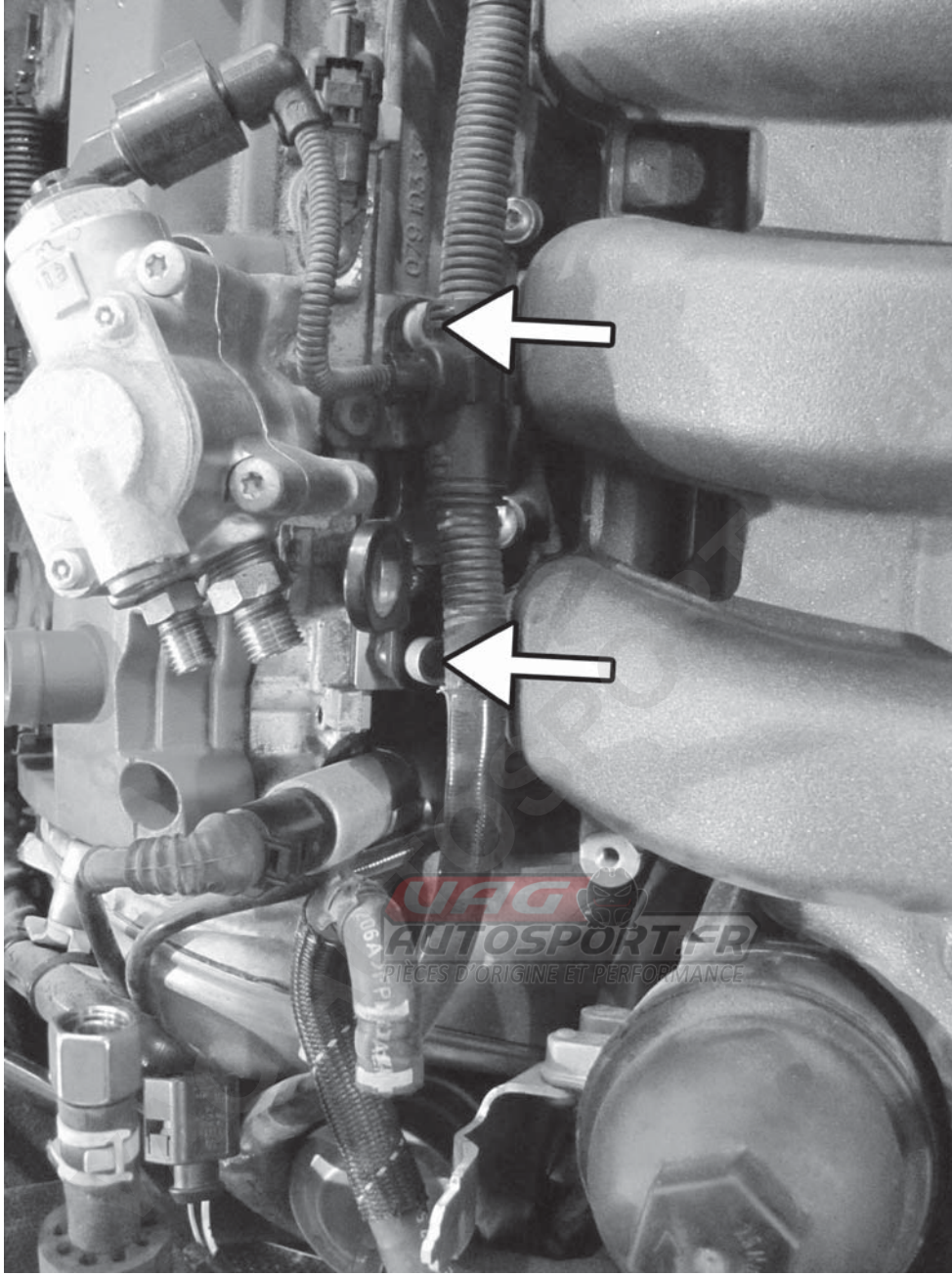

Created with

 **nitro** PDF[®] professional

download the free trial online at nitropdf.com/professional

APR, LLC
4800 US HWY 280 West Opelika Alabama 36801

43) Remove the electrical connections to the left side high pressure fuel pump and the left camshaft position sensor. Remove the two T30 screws holding the wiring harness brackets in place. Lift the harness out of the intake valley and over to the other side of the high pressure fuel pump.

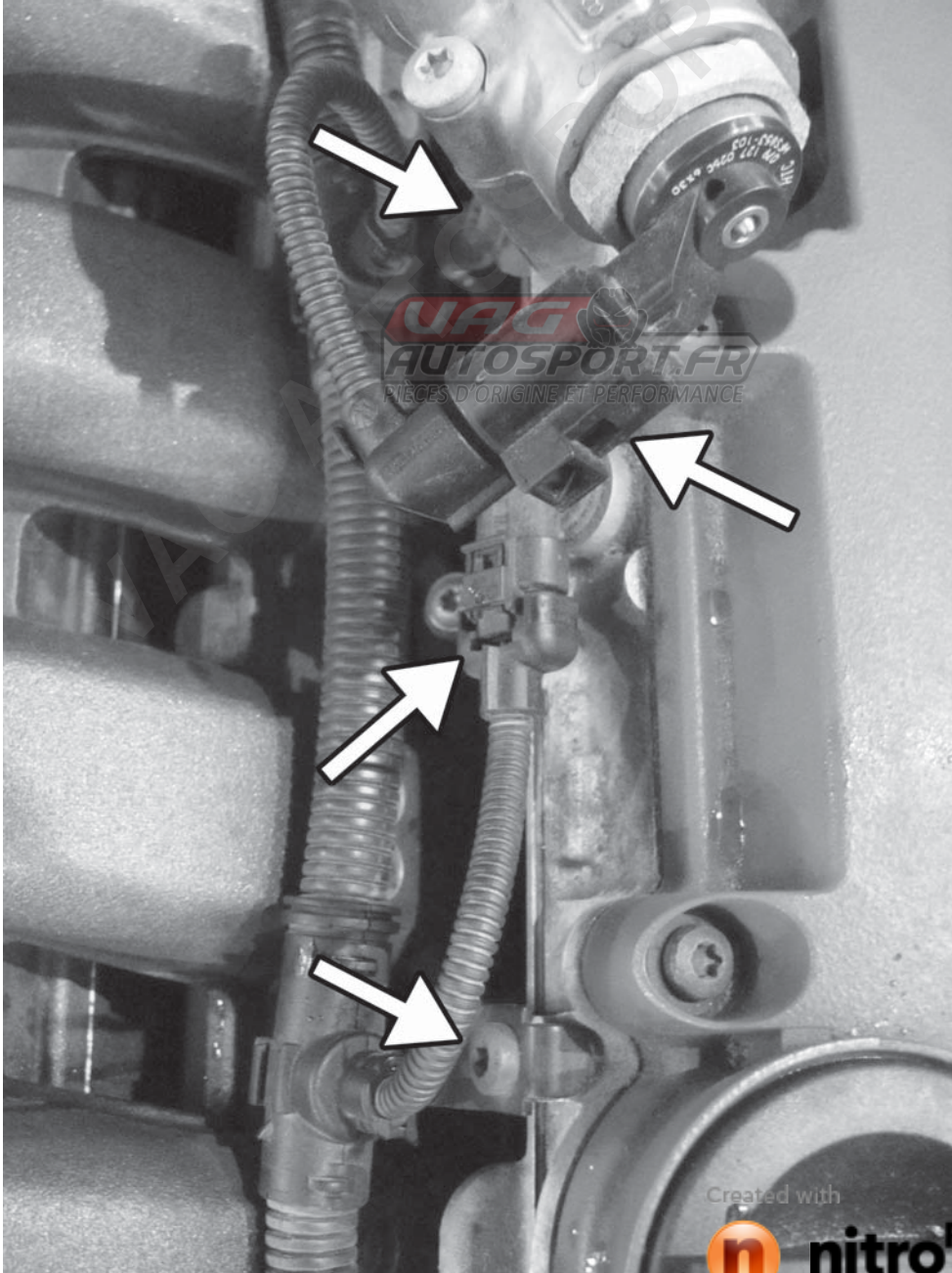

APR, LLC
Alabama 36801
4800 US HWY 280 West Opelika

44) Remove the coolant line from the lower portion of the Y-fitting by the firewall. The remaining line can then be bent back to the right side of the car and out of the way.

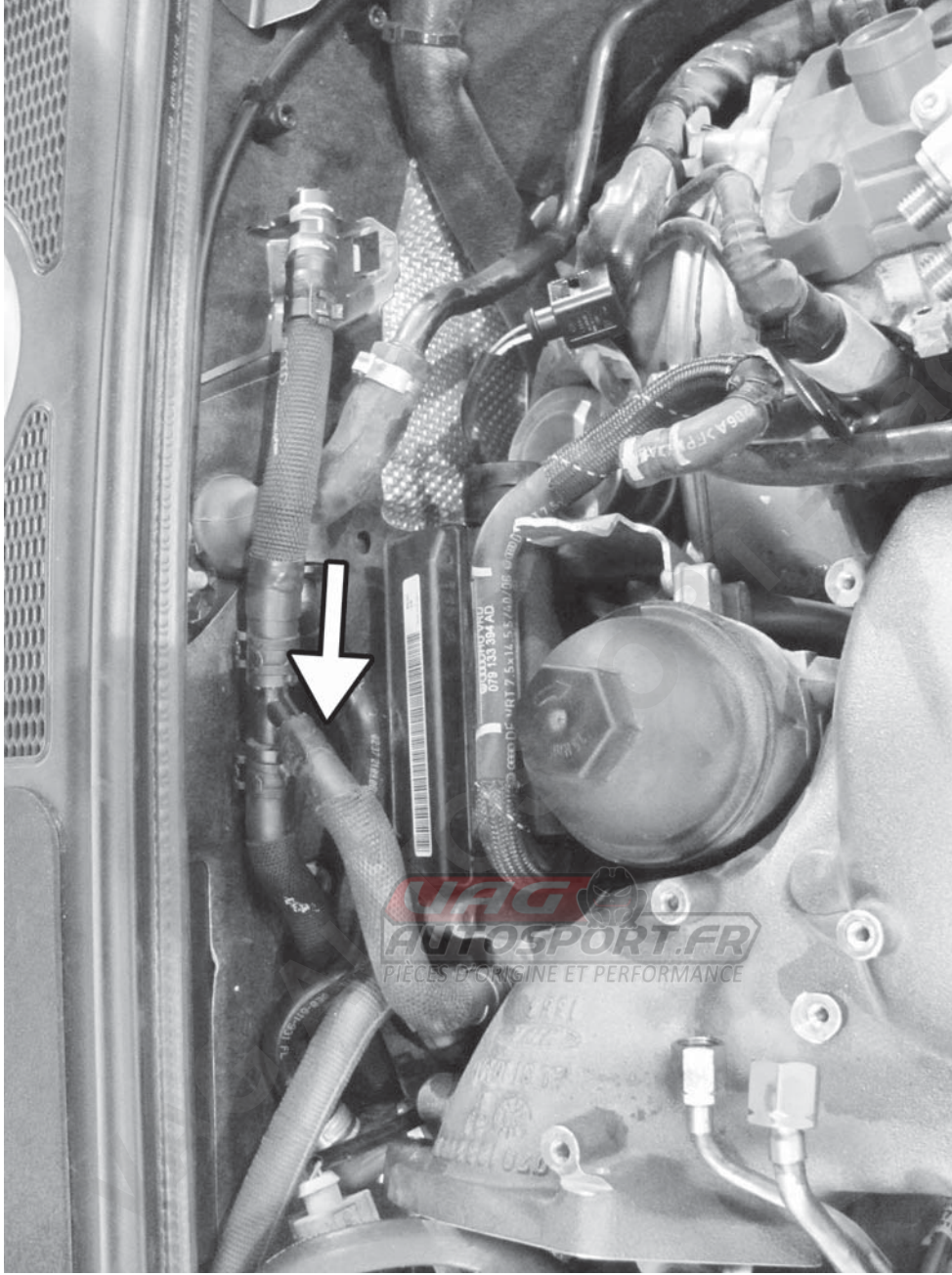

Created with



nitro PDF[®]

professional

download the free trial online at nitropdf.com/professional

APR, LLC
4800 US HWY 280 West Opelika Alabama 36801

45) Disconnect the check valve and hose from the brake booster line located on the firewall.

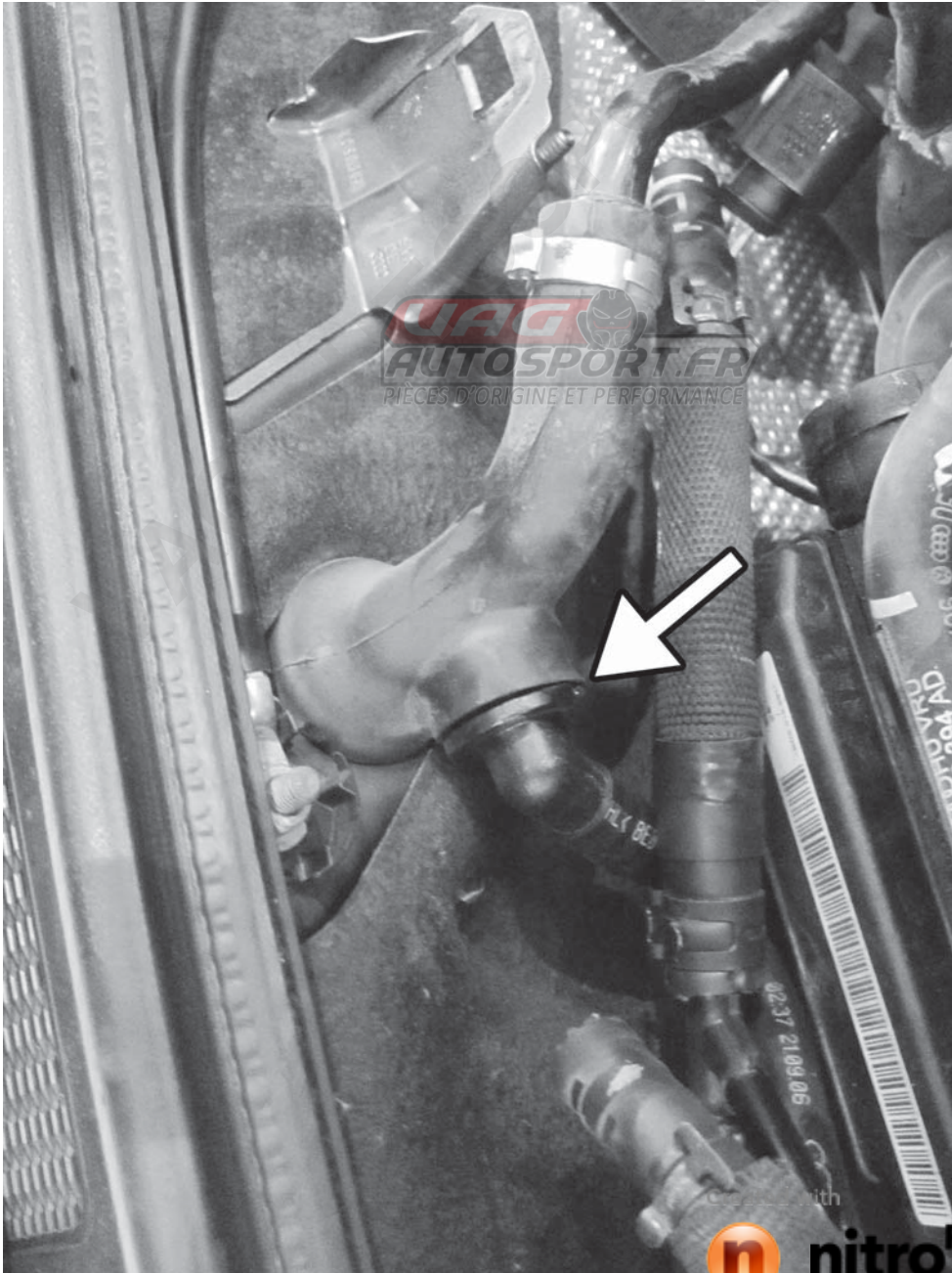

APR, LLC
Alabama 36801
4800 US HWY 280 West Opelika

46) On the rear of the left cylinder head, remove the upper pipe torx screw to the water pipe which also holds the combination valve bracket. Do NOT remove the lower water pipe screw.

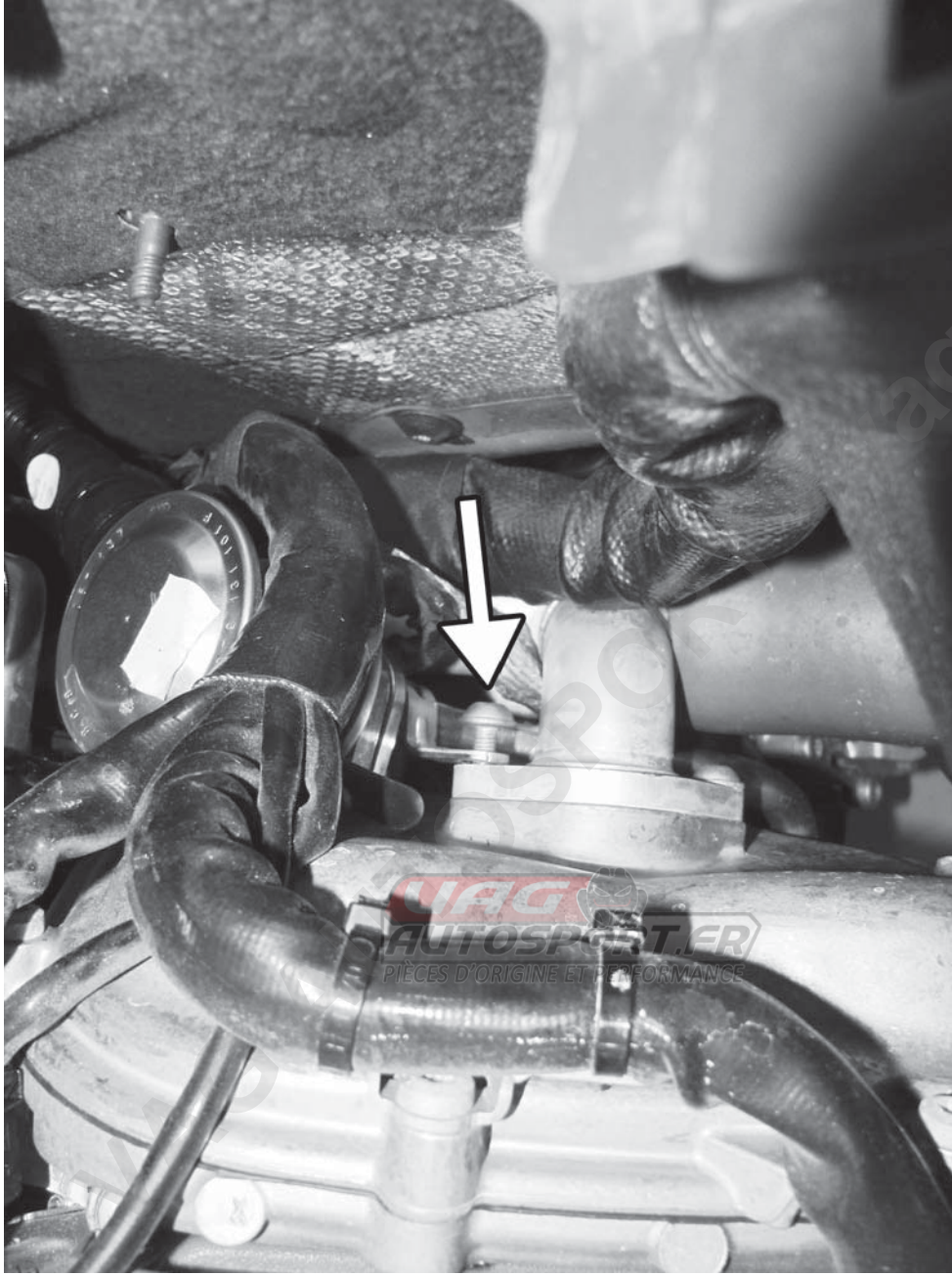

Created with

 **nitro** PDF[®] professional

download the free trial online at nitropdf.com/professional

APR, LLC
4800 US HWY 280 West Opelika Alabama 36801

47) On the rear of the right cylinder head, remove the two T30 screws that hold the secondary air pipe bracket to the water pipe. Do not remove the upper water pipe screw. You may now reinstall the lower water pipe screw once the bracket is removed.

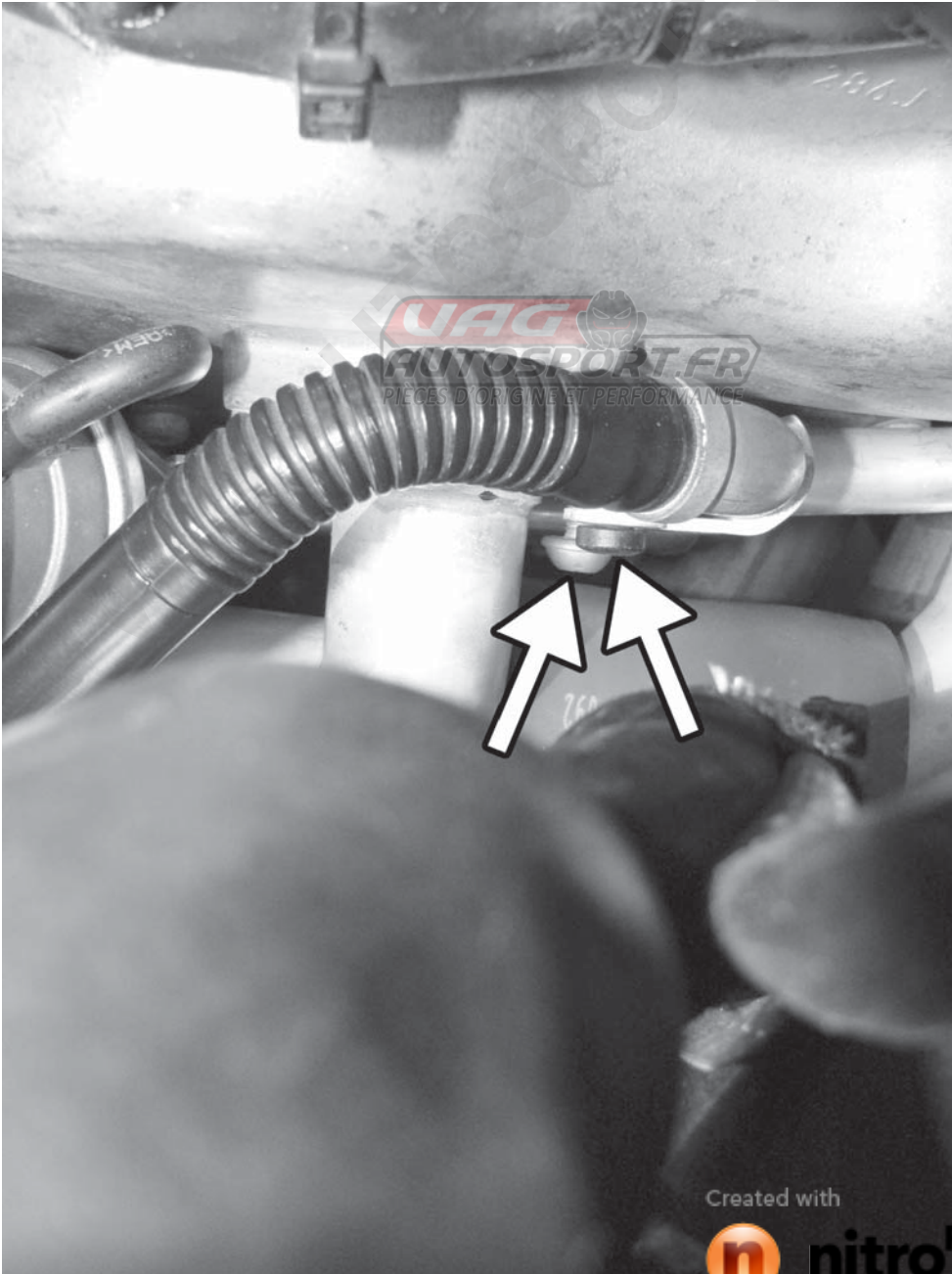

APR, LLC
Alabama 36801
4800 US HWY 280 West Opelika

Created with



nitro PDF

professional

download the free trial online at nitropdf.com/professional

48) Unclip the plastic secondary air tube from the right side combination valve. An angled pick will assist you in removing this clip.

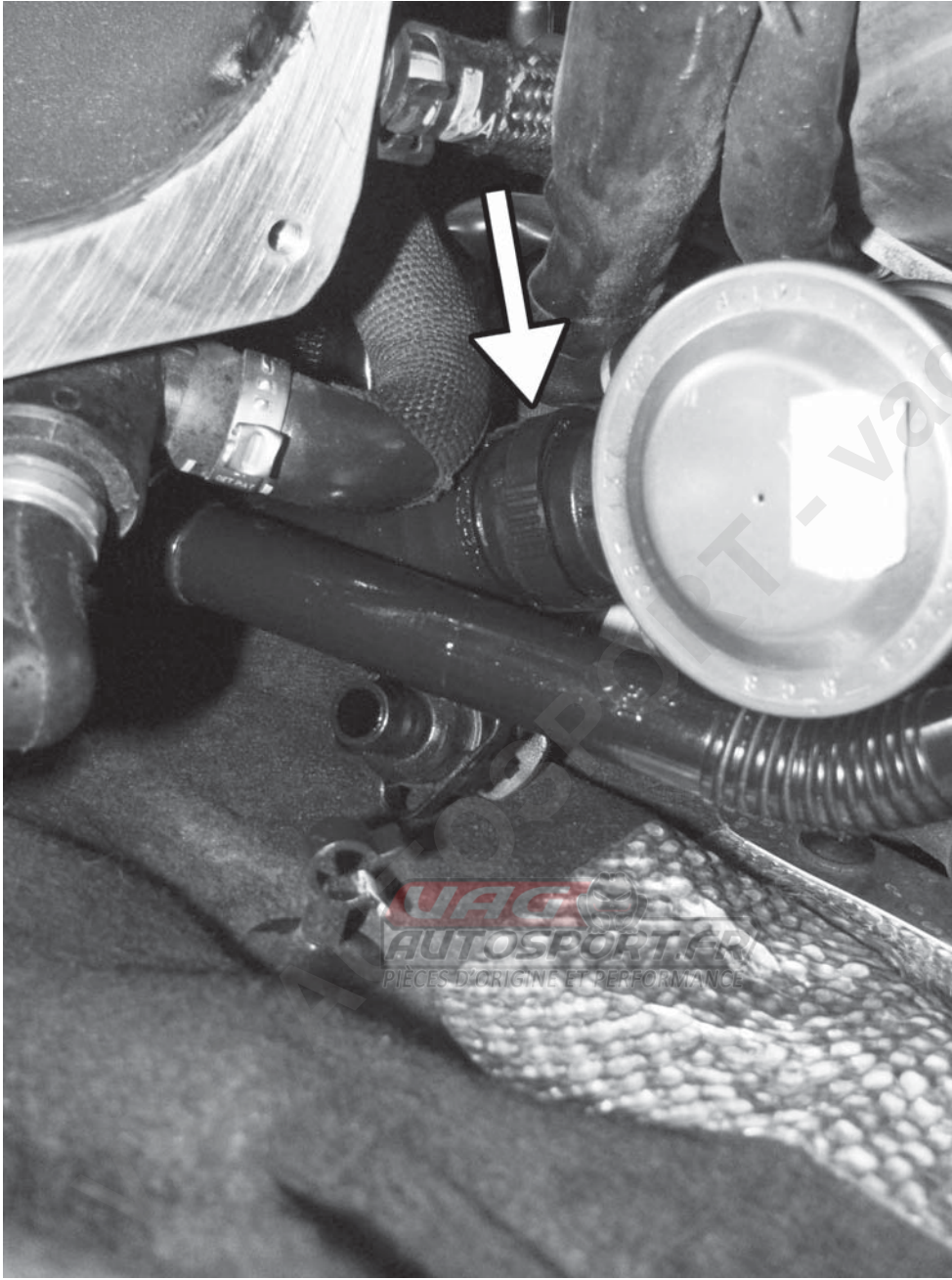

Created with



nitro PDF[®]

professional

download the free trial online at nitropdf.com/professional

APR, LLC
4800 US HWY 280 West Opelika Alabama 36801

49) Unclip the plastic secondary air tube from the left side combination valve. An angled pick will assist you in removing this clip. Rotate and lift the secondary air tube up out of the way.

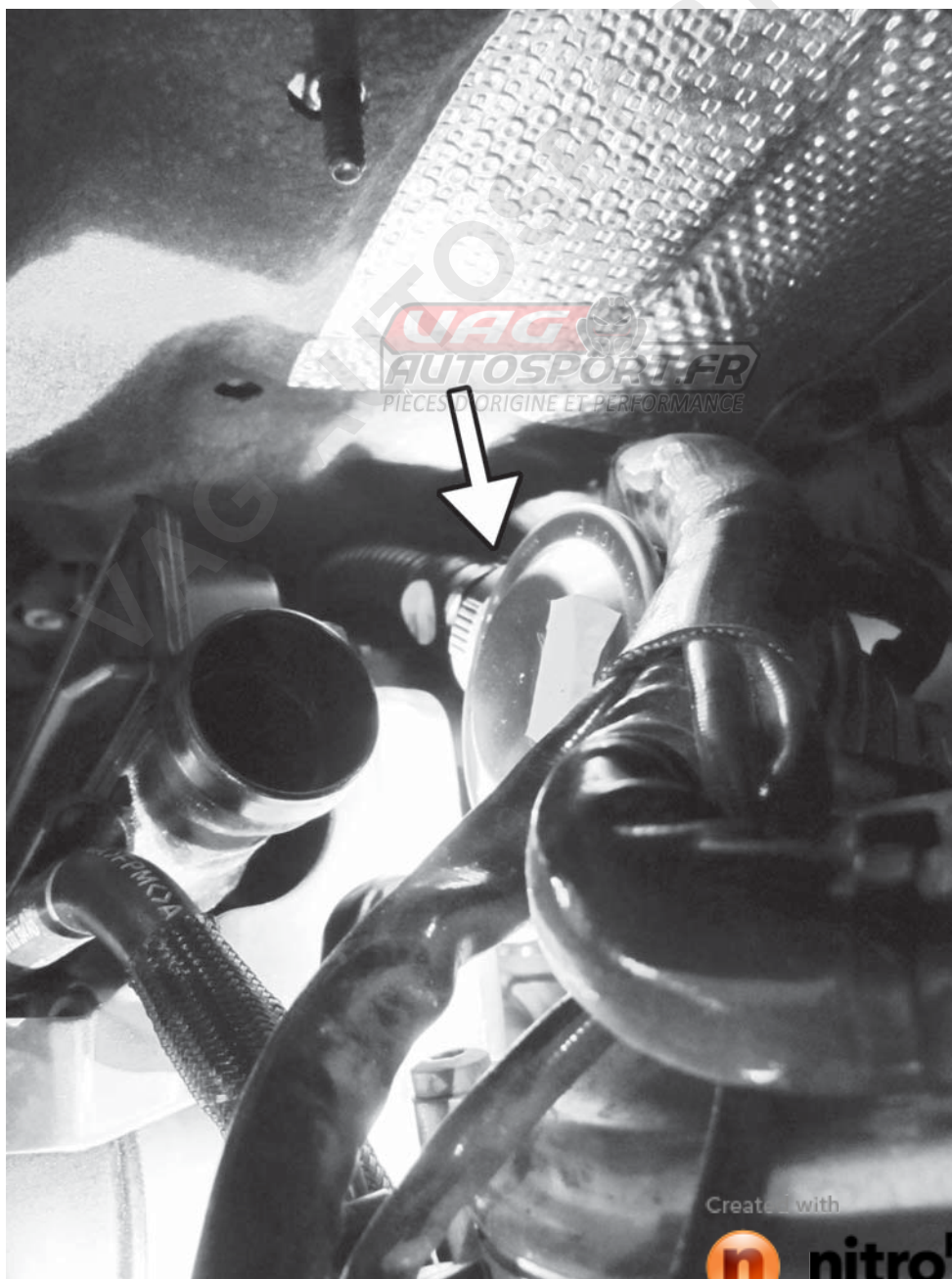

APR, LLC
4800 US HWY 280 West Opelika Alabama 36801

50) Remove the three T30 screws from the oil separator and pull the oil separator away from the intake manifold and coolant flange. Picture is shown with the intake manifold removed.

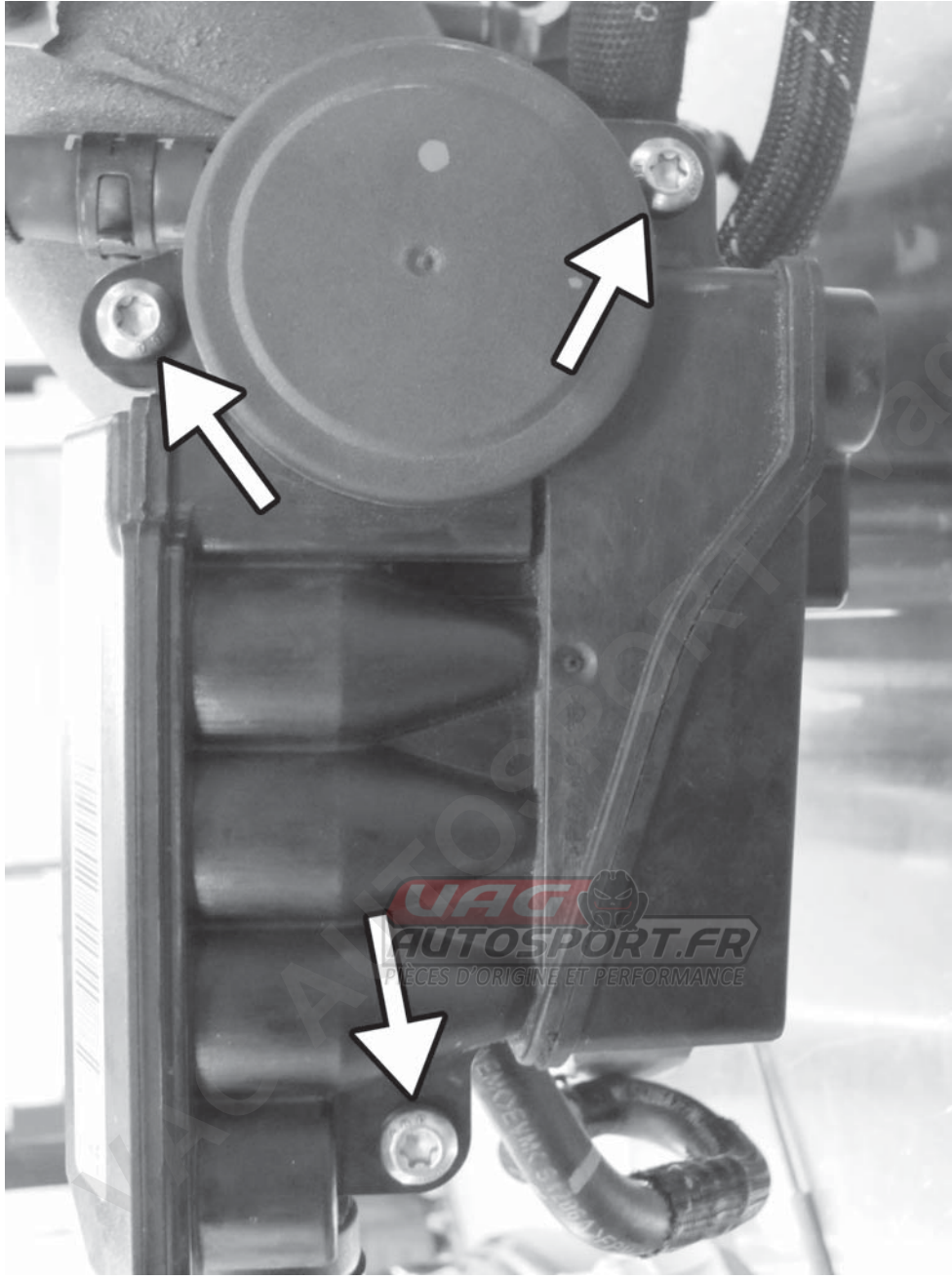

Created with



nitro PDF[®]

professional

download the free trial online at nitropdf.com/professional

APR, LLC
4800 US HWY 280 West Opelika Alabama 36801

51) Remove the T30 screw from the oil separator coolant flange and then pull the coolant flange out of the intake manifold. Picture is shown with the intake manifold removed.

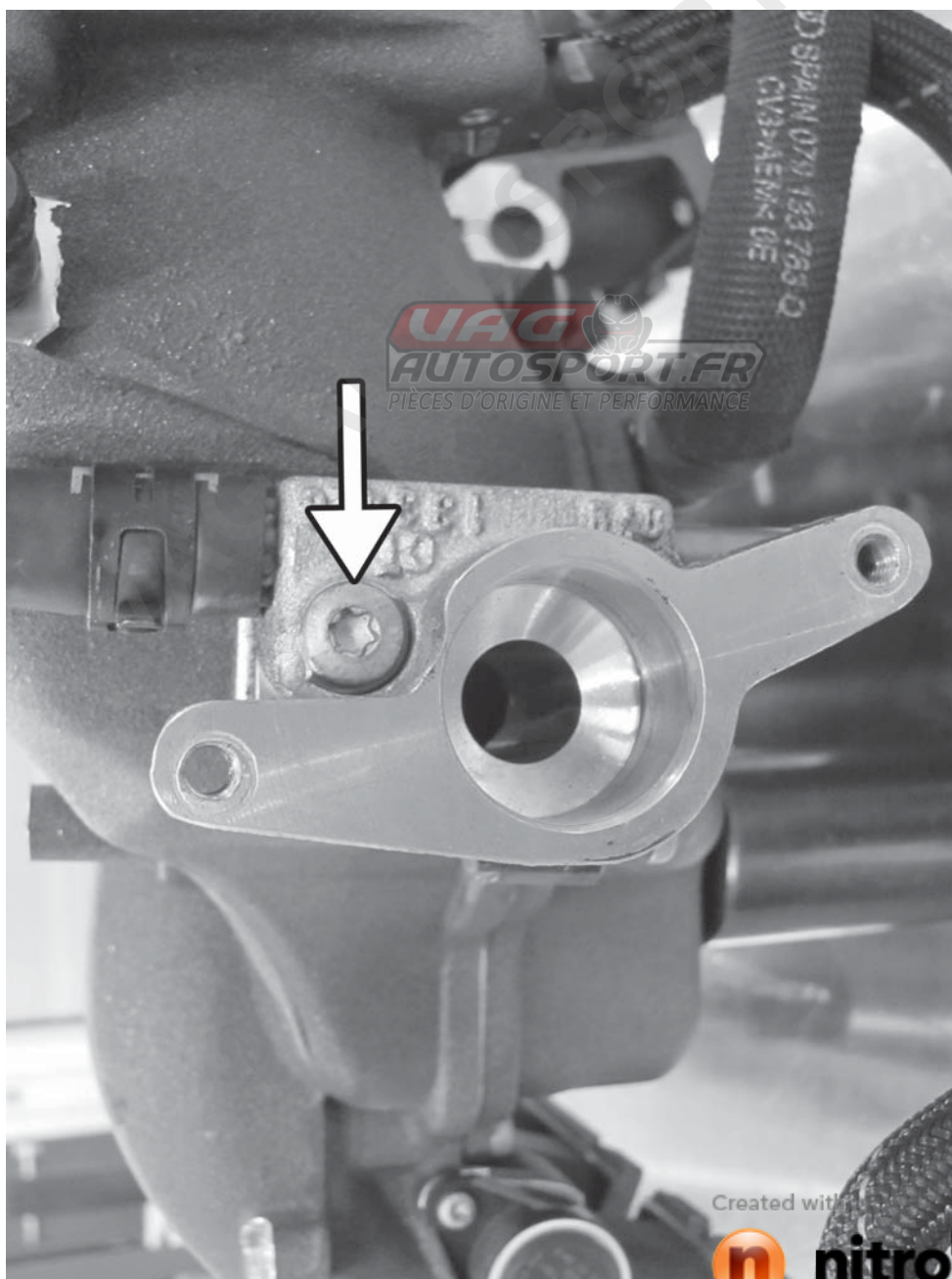

APR, LLC
Alabama 36801
4800 US HWY 280 West Opelika

52) Disconnect the electrical connector that goes to the rear IMRC sensor.

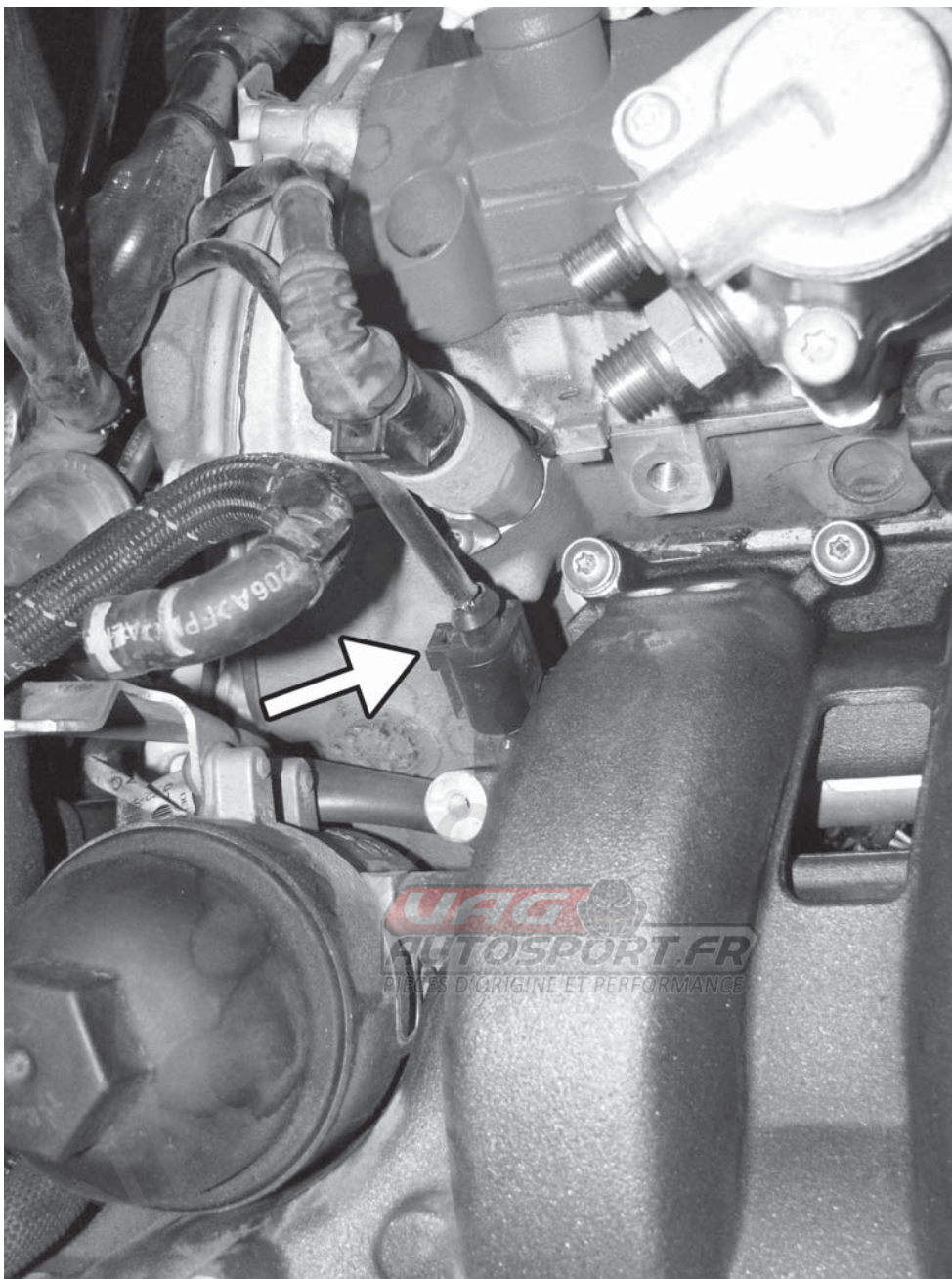

Created with

 **nitro** PDF[®] professional

download the free trial online at nitropdf.com/professional

APR, LLC
4800 US HWY 280 West Opelika Alabama 36801

g-autosport

53) Disconnect the electrical connector that goes to the rear IMRC sensor. Flip the connector and wires out of the way and cable tie it to the main harness it separates from, as it is not reused.

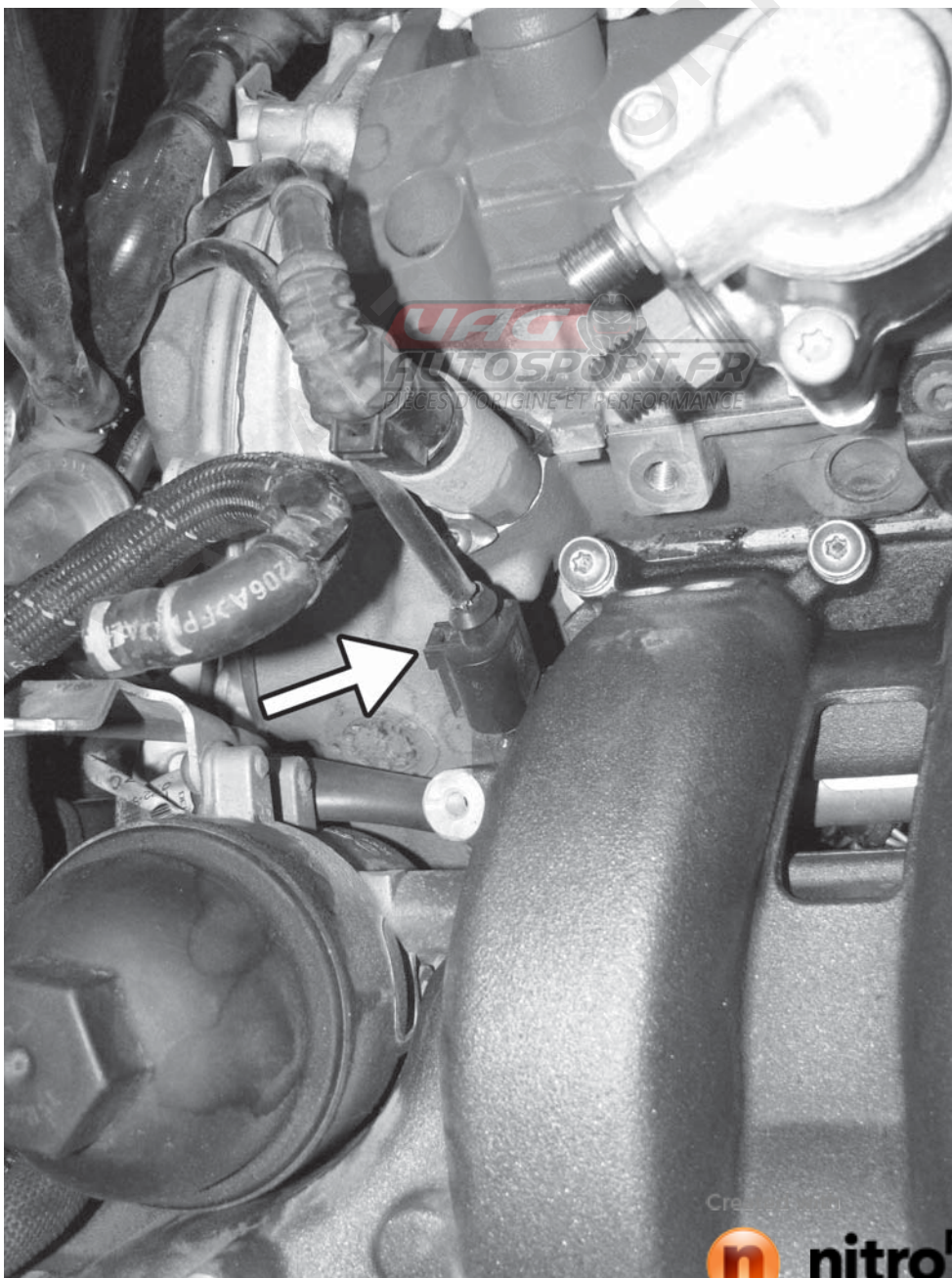

APR, LLC
Alabama 36801
4800 US HWY 280 West Opelika



nitro PDF

professional

download the free trial online at nitropdf.com/professional

54) Using compressed air, clean the area around the intake manifold to prevent debris and dirt from getting in the engine with the manifold removed. Remove the ten T30 torx screws in the sequence shown.

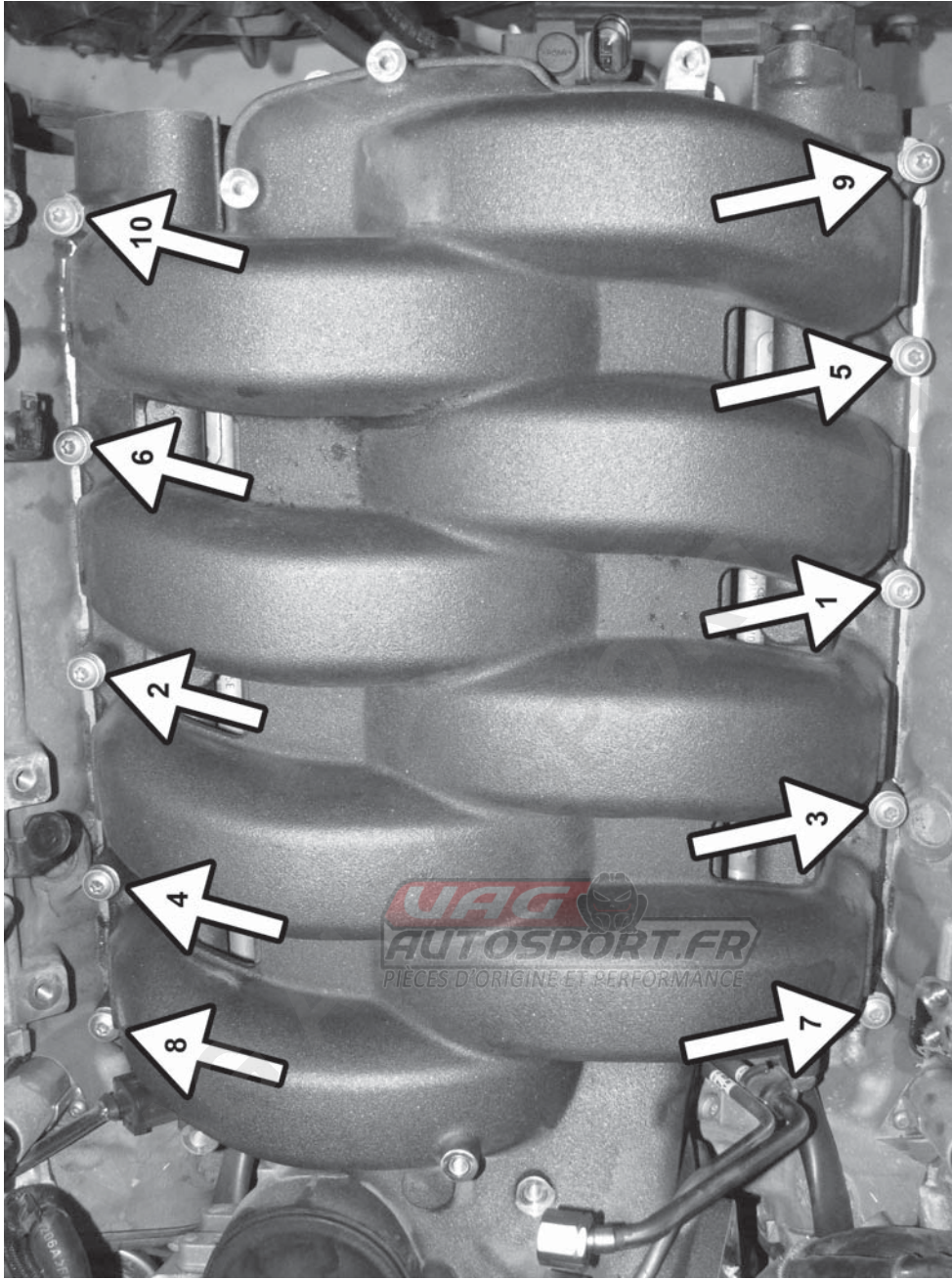

Created with

 **nitro** PDF[®] professional

download the free trial online at nitropdf.com/professional

APR, LLC
4800 US HWY 280 West Opelika Alabama 36801

55) Remove the intake manifold from the car by lifting from the front of the manifold and then lifting the left side of the manifold. Use this rotating procedure to swing the manifold clear of the remaining high pressure fuel lines and remove the manifold from the car. Be careful to not bend the high pressure fuel lines. It is highly recommended that you cover the intake ports of the cylinder head with a rag or cloth once the manifold is removed.

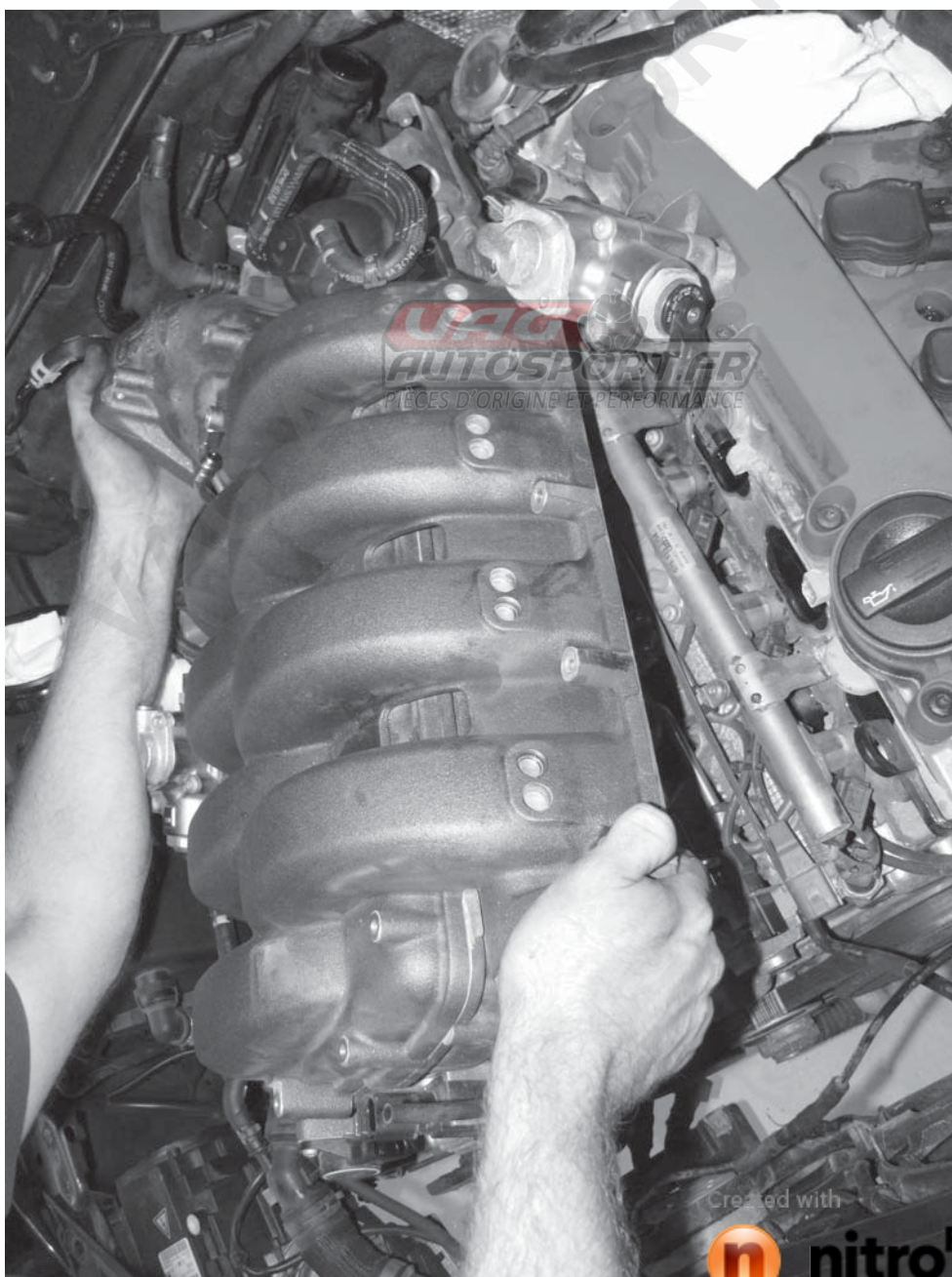

APR, LLC
Alabama 36801
4800 US HWY 280 West Opelika

Created with



nitro PDF

professional

download the free trial online at nitropdf.com/professional

56) From the bottom of the stock intake manifold, remove the check valve and rubber elbow.

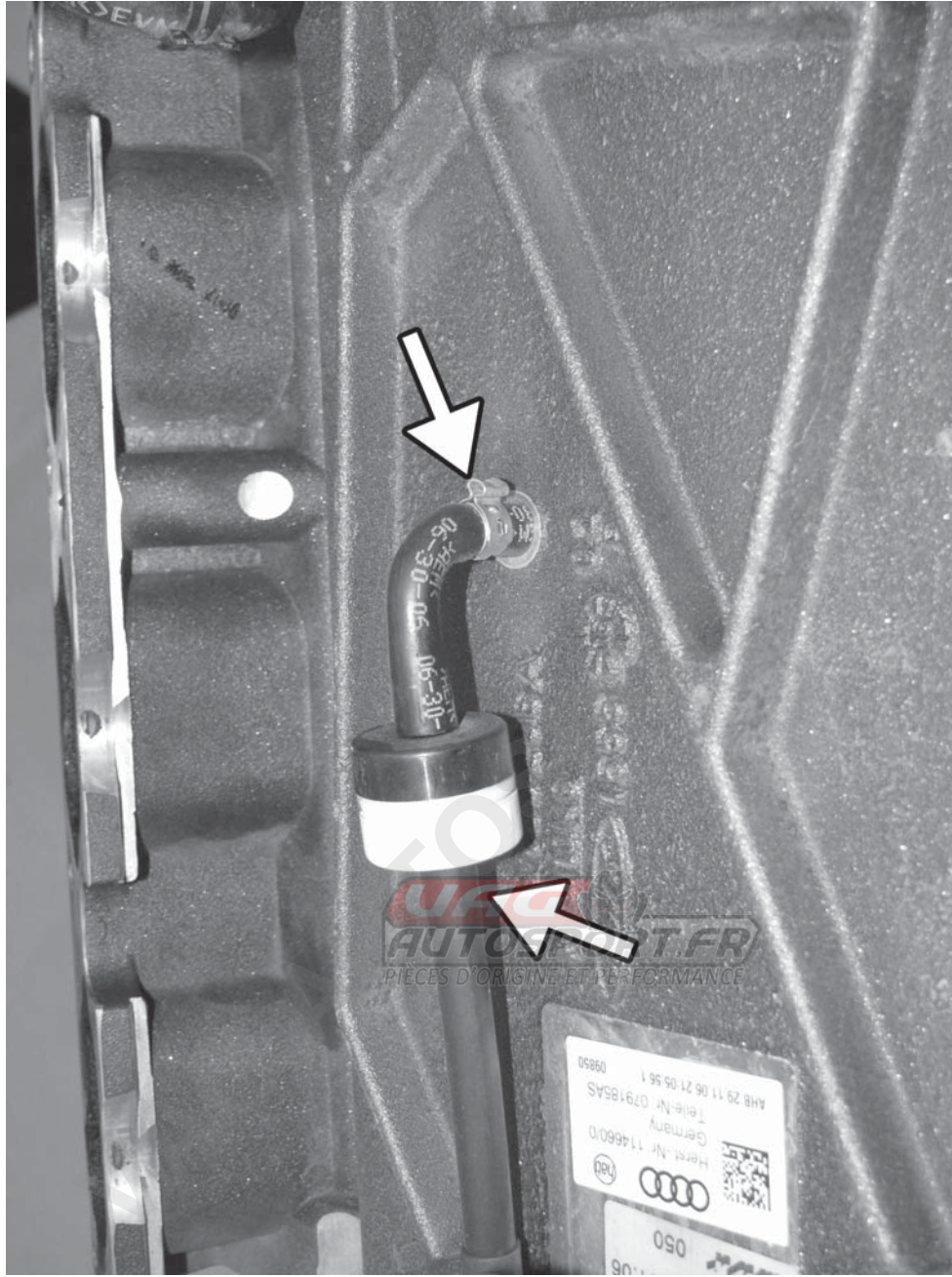

Created with

 **nitro** PDF[®] professional

download the free trial online at nitropdf.com/professional

APR, LLC
4800 US HWY 280 West Opelika Alabama 36801

57) Cut the hose clamp to the drain line of the oil separator and remove the oil separator from the car.

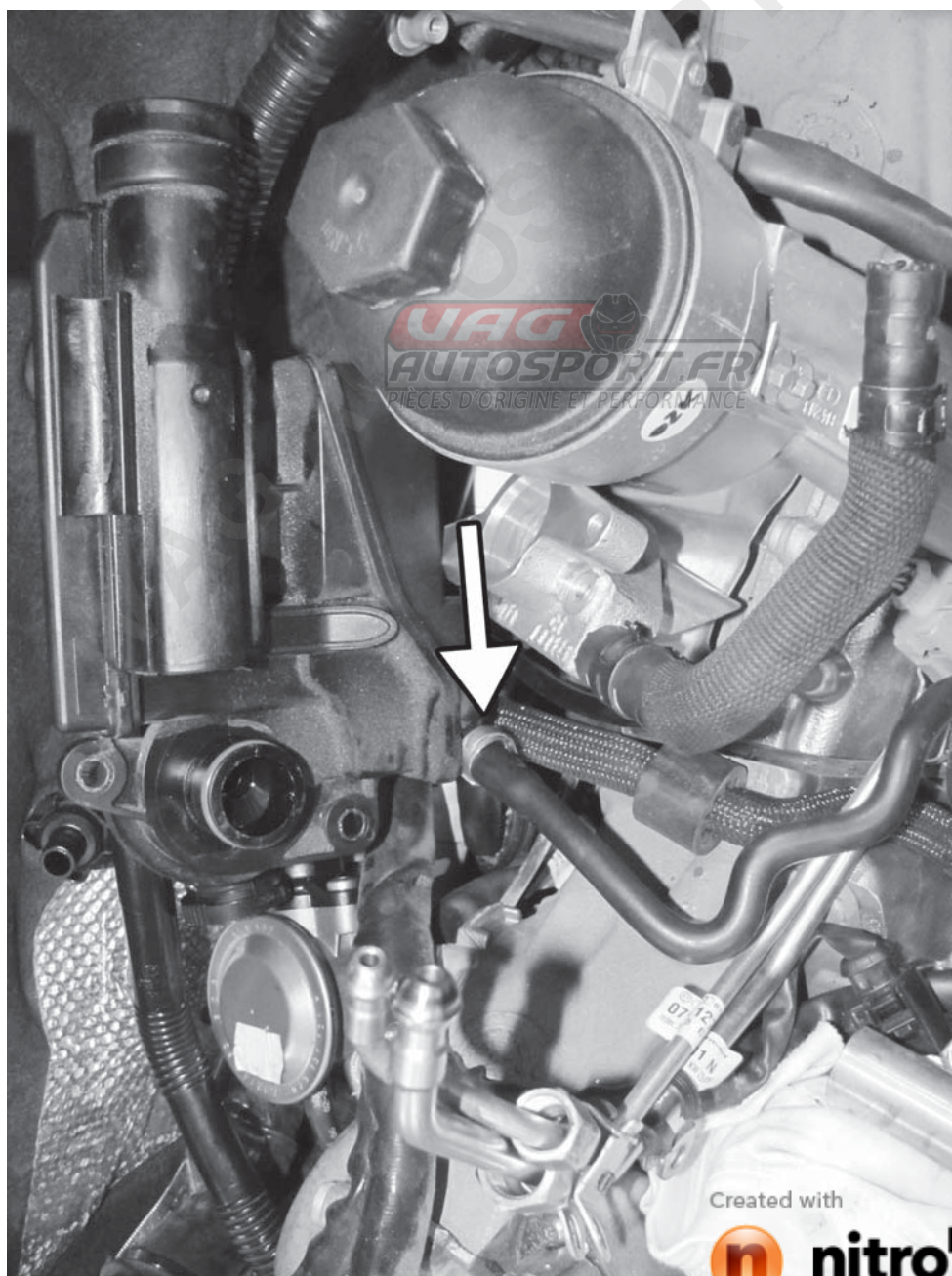

APR, LLC
Alabama 36801
4800 US HWY 280 West Opelika

58) Remove the lower hose clamp from the oil separator coolant flange and remove the flange from the car.

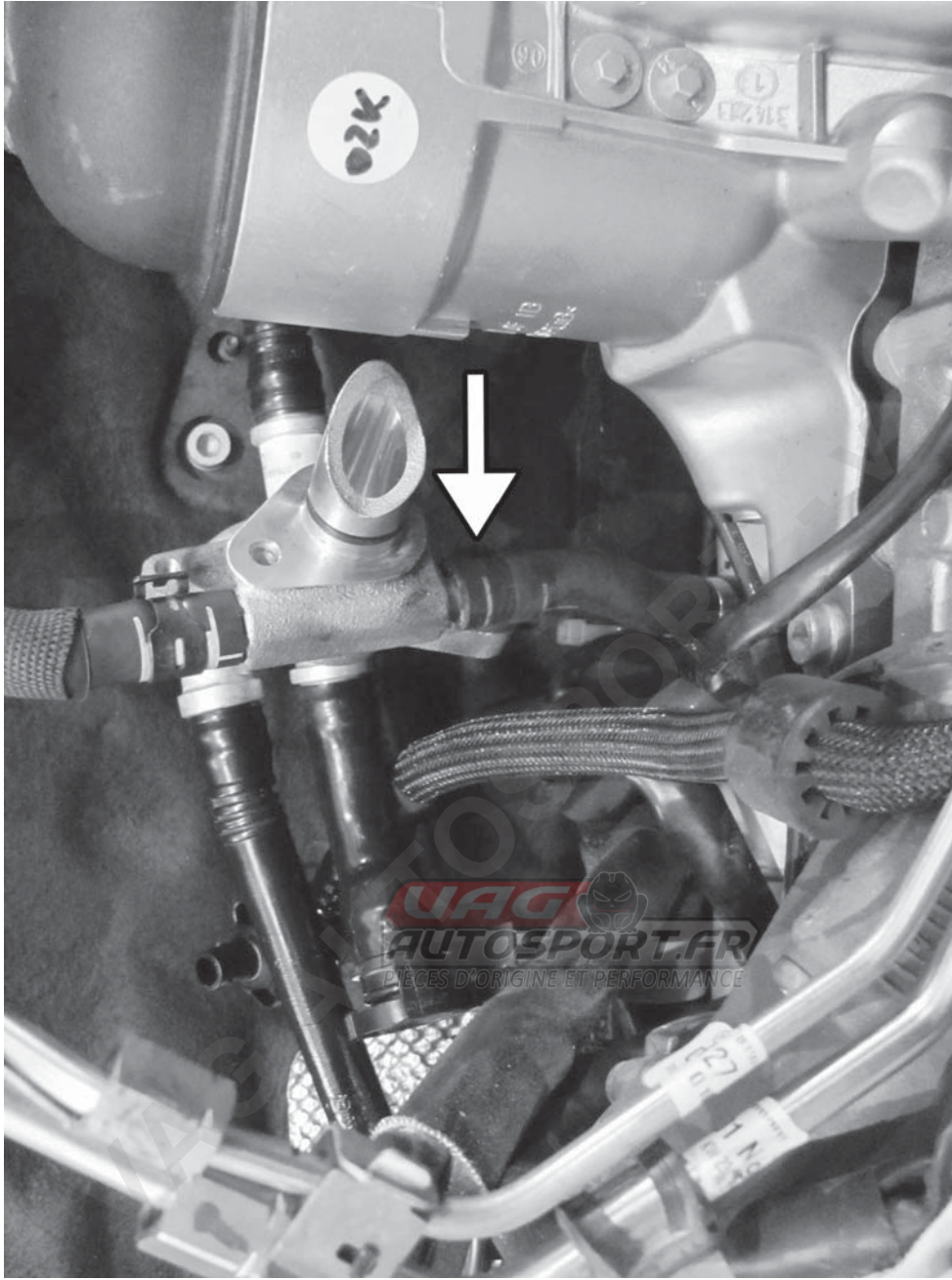

Created with

 **nitro** PDF[®] professional

download the free trial online at nitropdf.com/professional

APR, LLC
4800 US HWY 280 West Opelika Alabama 36801

59) Remove the vacuum line elbow from the N112 valve on the engine crankcase. Extend 18" with supplied vacuum line and clamp. Slide the rubber grommet that is around the PCV line out from the crankcase area and back towards the firewall of the car.

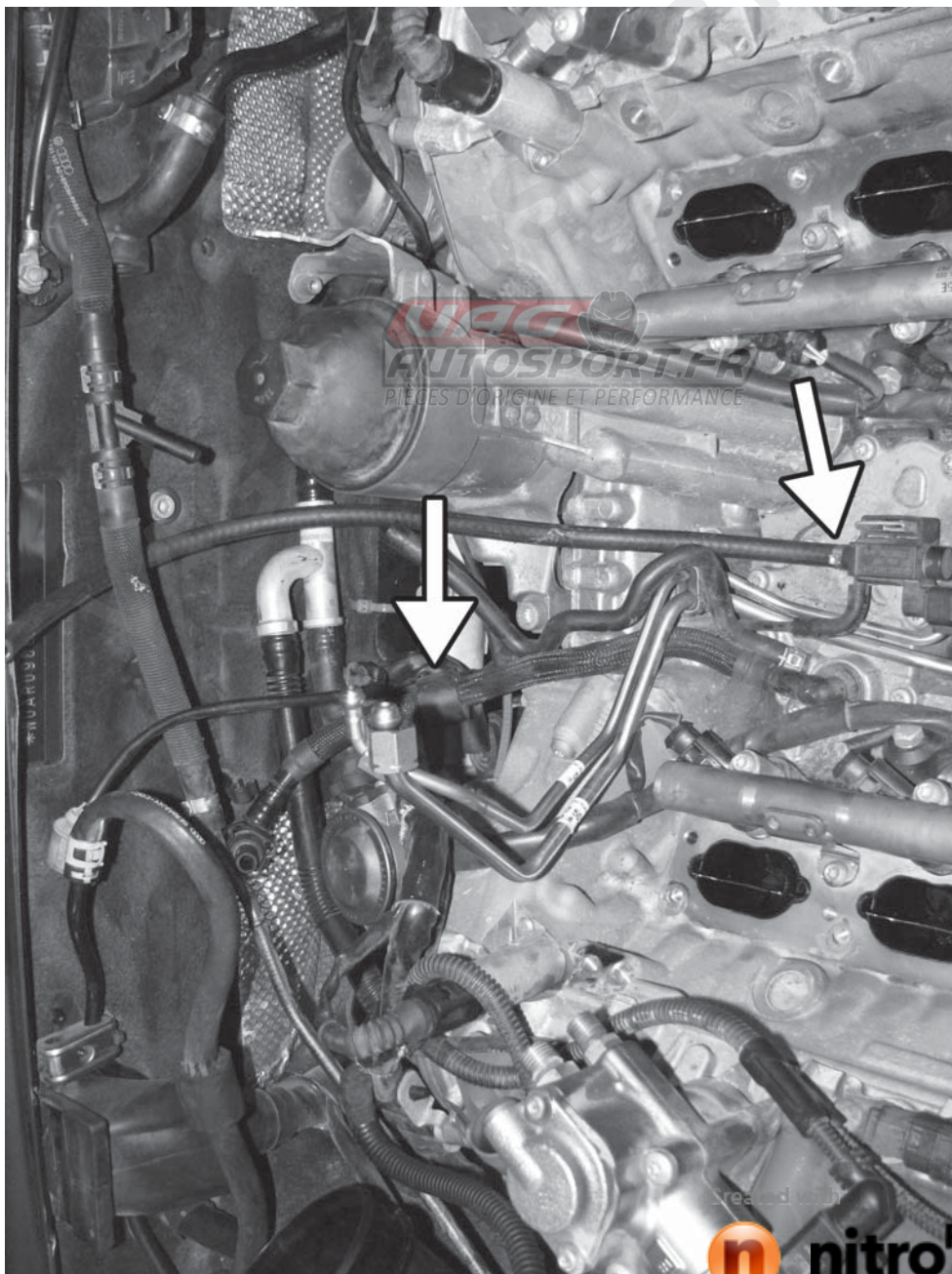

APR, LLC
Alabama 36801
4800 US HWY 280 West Opelika



nitro PDF

professional

download the free trial online at nitropdf.com/professional

60) Remove the two T30 torx screws and bracket that previously held the N80 valve and the oil separator from the car.

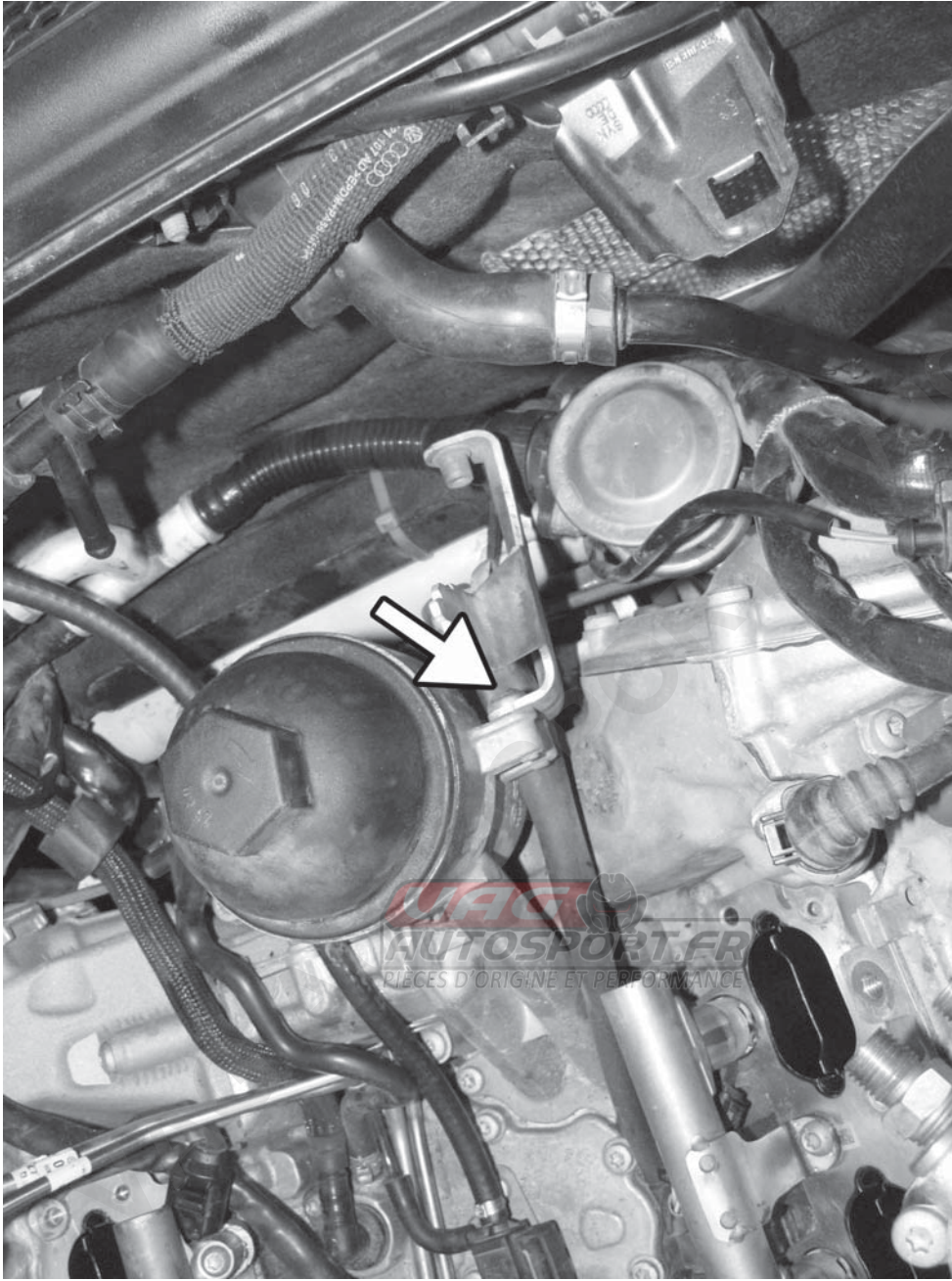

Created with

 **nitro** PDF[®] professional

download the free trial online at nitropdf.com/professional

APR, LLC
4800 US HWY 280 West Opelika Alabama 36801

61) Slide the electrical connectors for the knock sensors out of the bracket they are held in. Remove the one T30 torx screw holding that bracket and remove the bracket from the car.

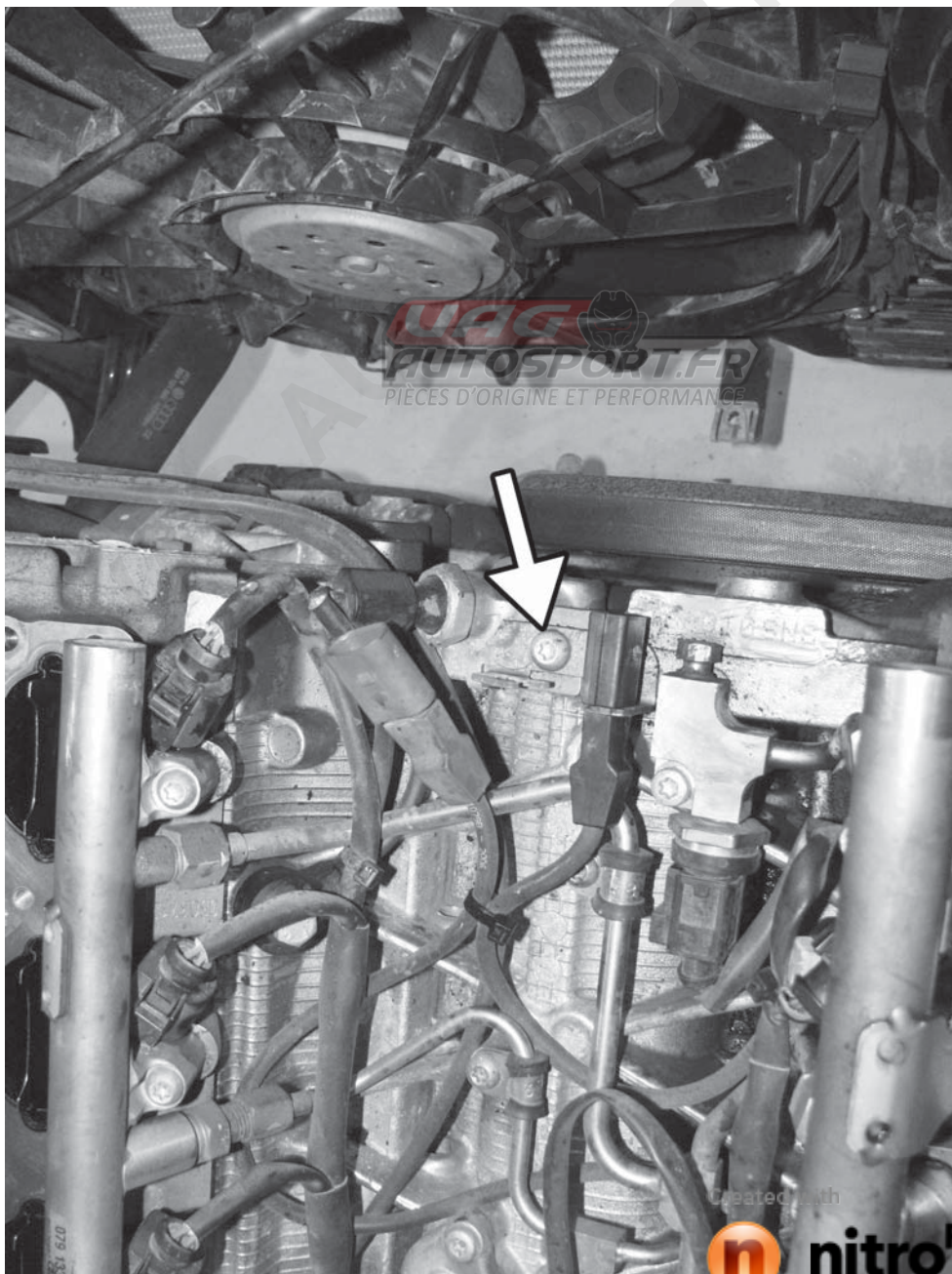

APR, LLC
Alabama 36801
4800 US HWY 280 West Opelika

62) Loosely route the left upper engine harness into its original location. Route the knock sensor connectors from this harness underneath the #5 fuel injector wiring harness. Connect the two knock sensor connectors.

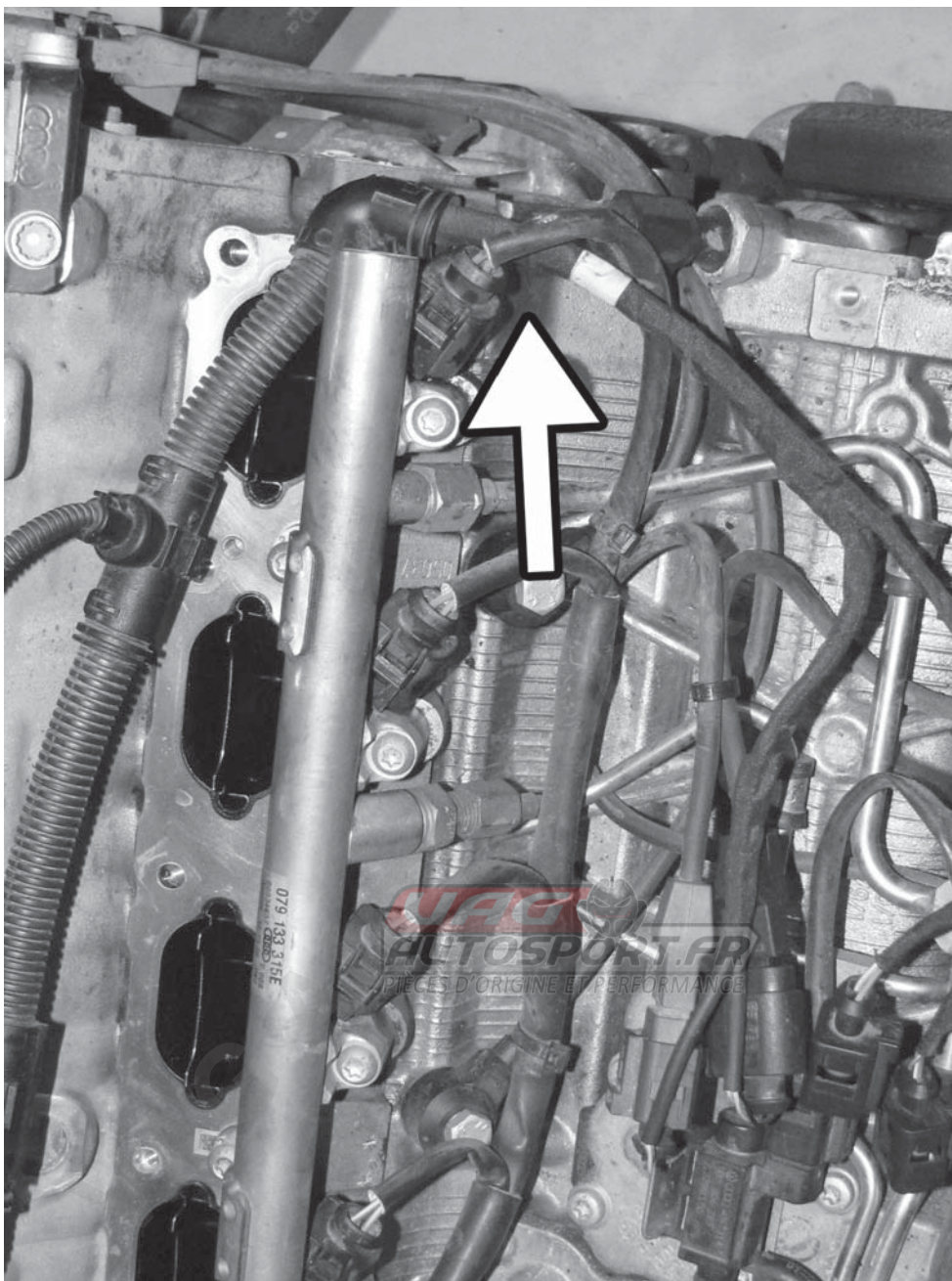

Created with

 **nitro** PDF[®] professional

download the free trial online at nitropdf.com/professional

APR, LLC
4800 US HWY 280 West Opelika Alabama 36801

63) Secure the connected knock sensor connectors and the unconnected IMRC connectors to the top of the crankcase. Be aware that all of the connectors must be below the top of the N112 mounting tab and away from the front edge of the crankcase. Also, the left upper harness should be loose enough to be moved out of the way for the supercharger installation.

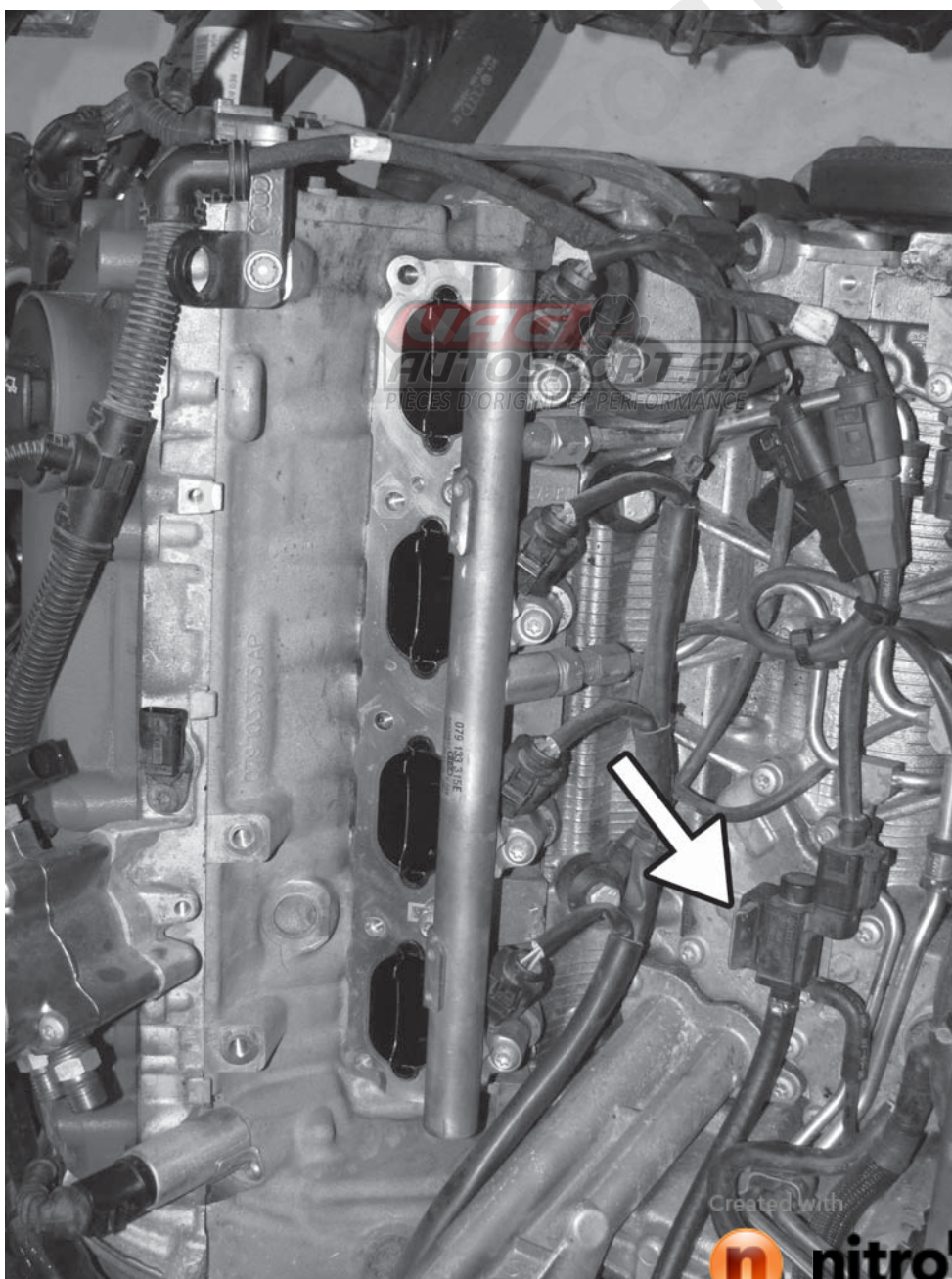

APR, LLC
Alabama 36801
4800 US HWY 280 West Opelika

64) With a 3/8" square drive adaptor on the belt tensioner, remove the serpentine belt from the car by rotating clockwise and sliding the belt off.

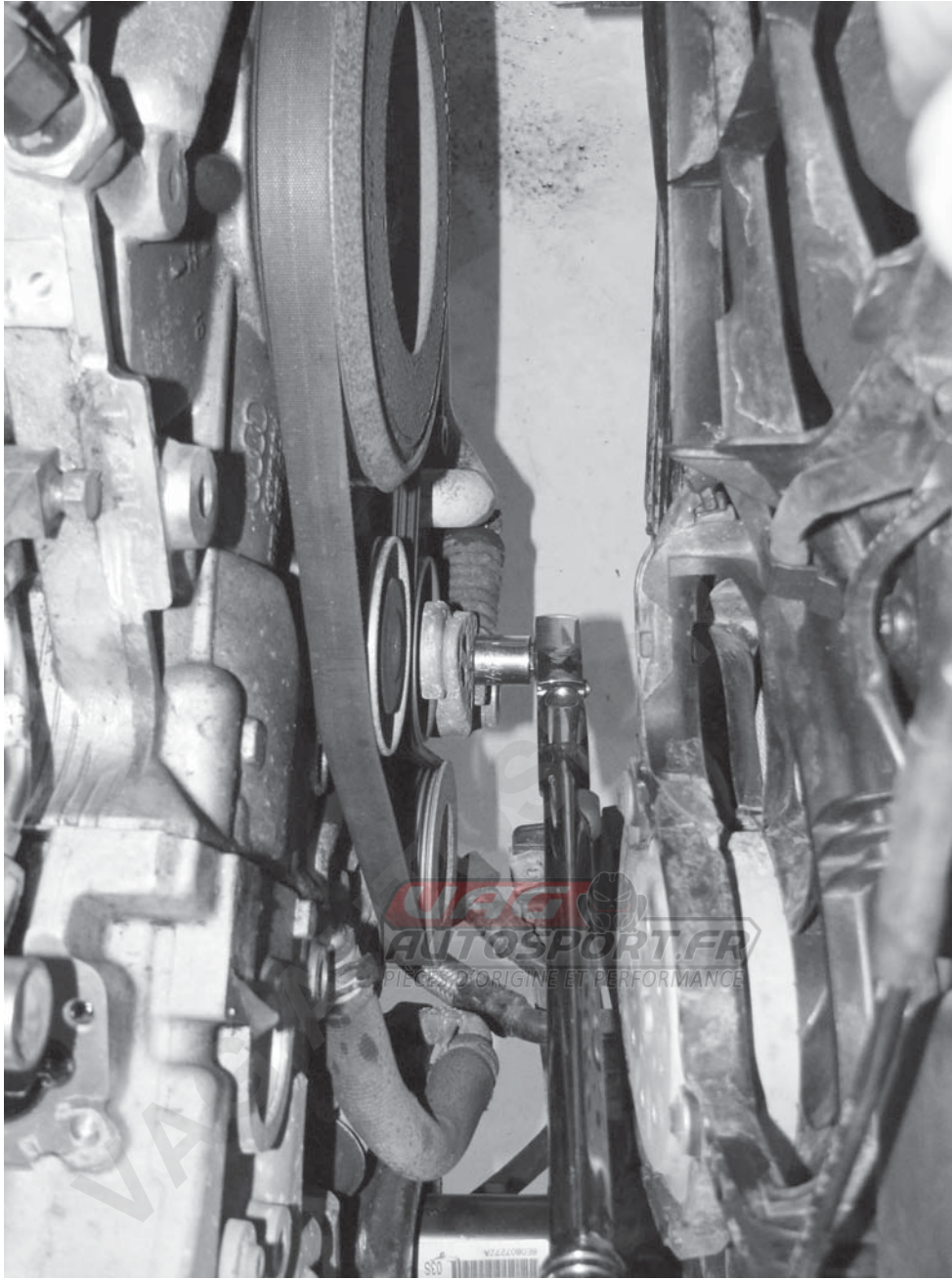

Created with

 **nitro** PDF[®] professional

download the free trial online at nitropdf.com/professional

APR, LLC
4800 US HWY 280 West Opelika Alabama 36801

65) Install the two supplied idler pulley mounting adaptors and torque to 55 lb-ft with a 24MM socket.

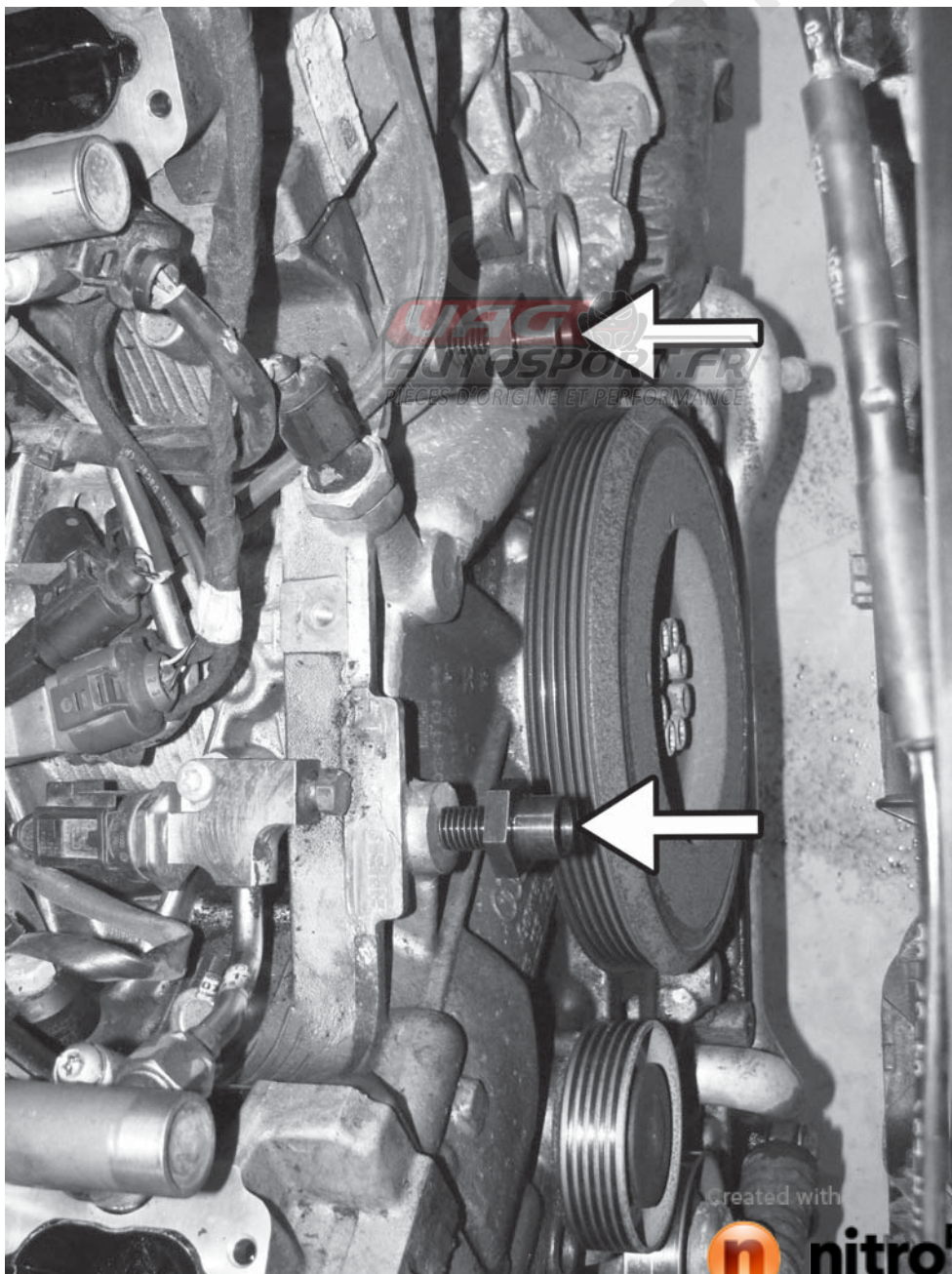

APR, LLC
4800 US HWY 280 West Opelika Alabama 36801

66) Install the two supplied idler rollers with the part numbers on the rollers facing away from the engine. Torque the 5MM allen bolts to 10 lb-ft.

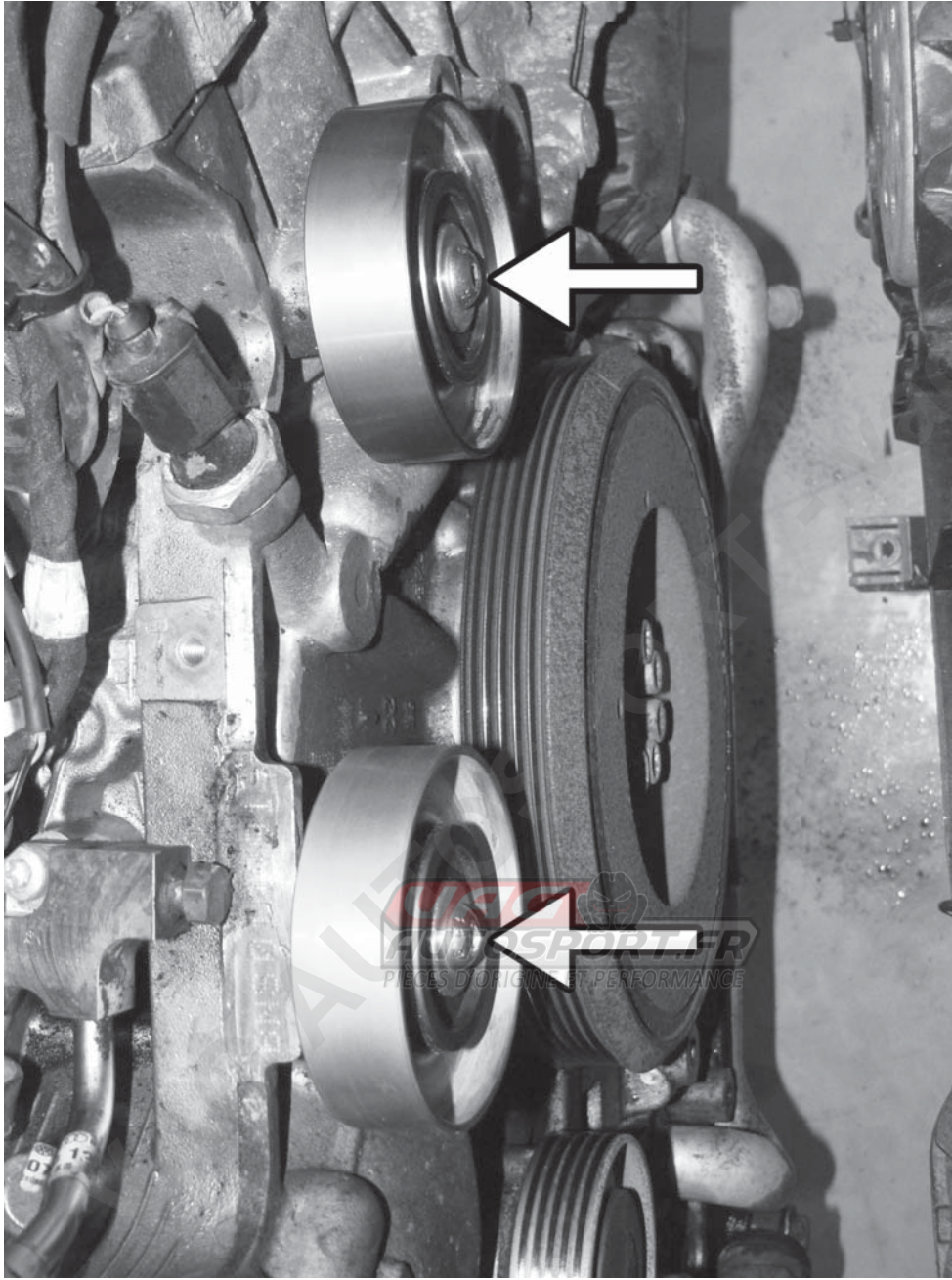

Created with



nitroPDF[®]

professional

download the free trial online at nitropdf.com/professional

APR, LLC
4800 US HWY 280 West Opelika Alabama 36801

67) To prevent chafing, install the supplied foam tape around the knock sensor wires where they come close to the cylinder head. Zip tie the harnesses together and out of the way.



APR, LLC
Alabama 36801
4800 US HWY 280 West Opelika



nitro PDF

professional

download the free trial online at nitropdf.com/professional

68) Remove the upper coolant hose from the oil separator coolant flange. Install the barbed fitting and 6.5" of supplied coolant hose to the end of the flange was previously attached. Install the extended coolant line in the car between the upper Y-fitting and the hard water pipe.

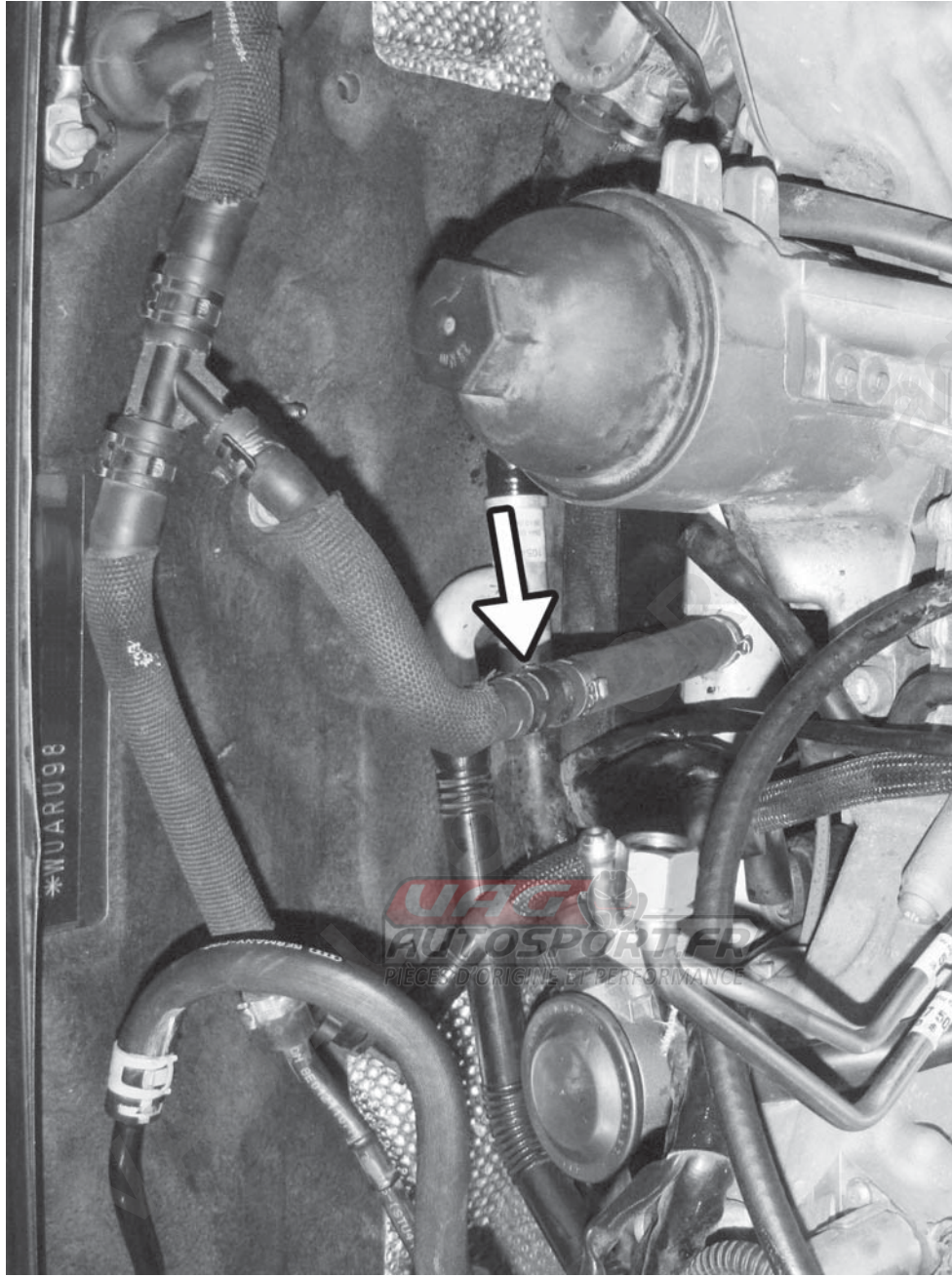

Created with



nitro PDF[®]

professional

download the free trial online at nitropdf.com/professional

APR, LLC
4800 US HWY 280 West Opelika Alabama 36801

69) Remove the 6MM allen bolt from the firewall of the car. Loosely install the APR bracket with the supplied bolt and lockwasher. Clock the bracket in the orientation shown.

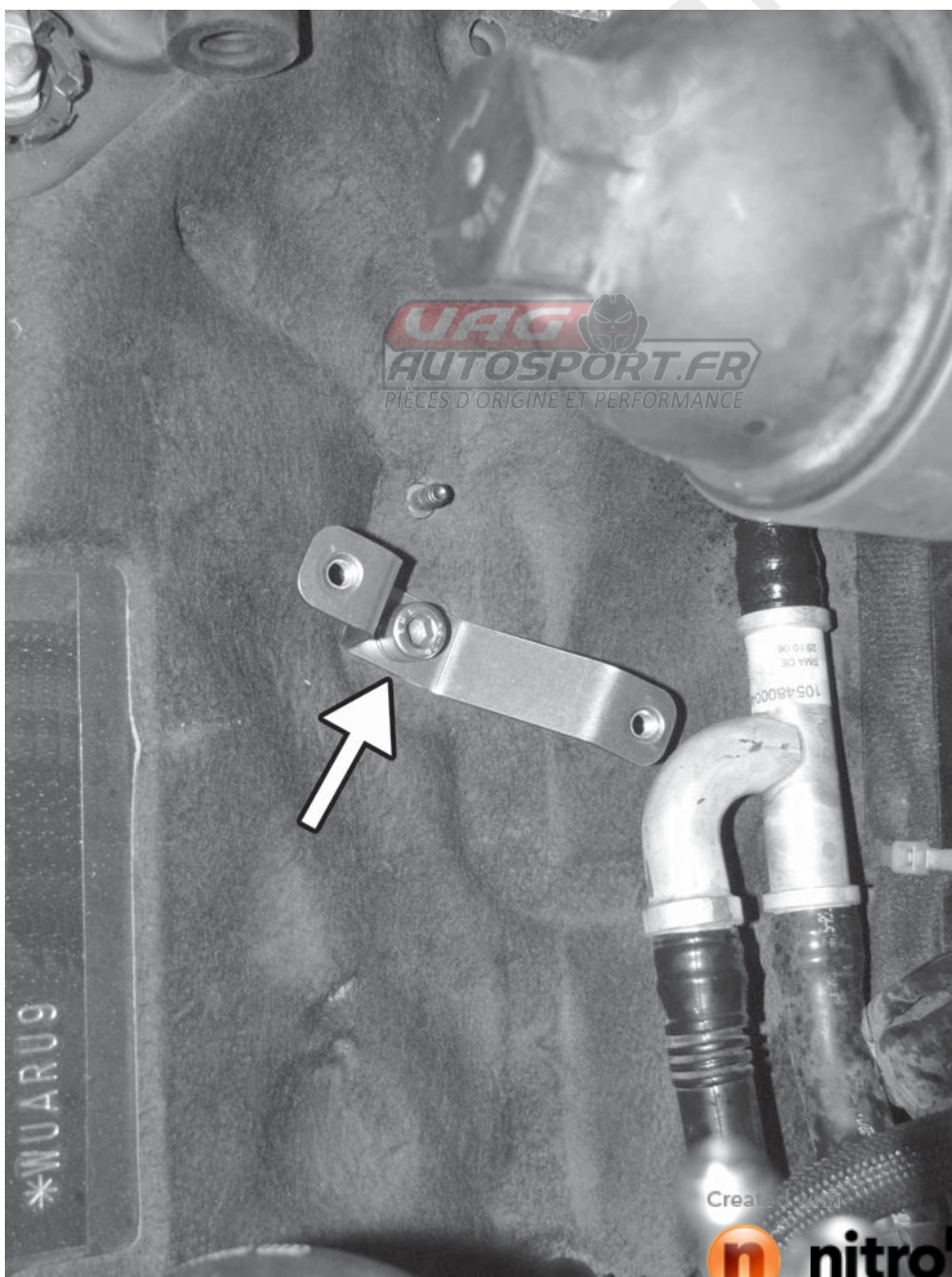

APR, LLC
4800 US HWY 280 West Opelika Alabama 36801



nitro PDF

professional

download the free trial online at nitropdf.com/professional

70) Assemble the APR hardware on to oil separator as shown using the supplied screws, lockwashers, and spacers.

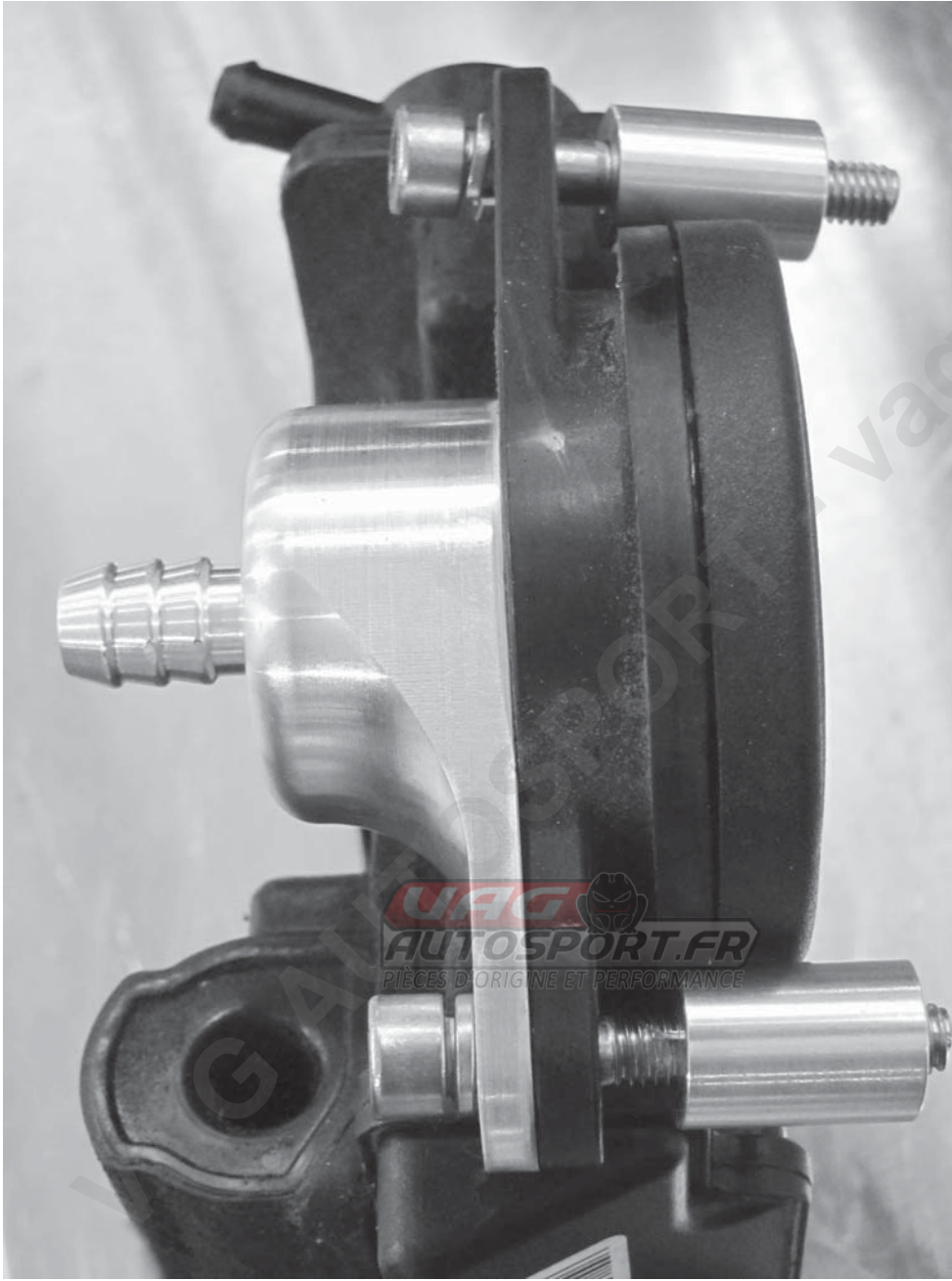

Created with



nitro PDF[®]

professional

download the free trial online at nitropdf.com/professional

APR, LLC
4800 US HWY 280 West Opelika Alabama 36801

71) Loosely bolt the oil separator to the APR bracket on the firewall. Make sure the firewall bracket is rotated so that the oil separator is level. Once level, tighten the bracket on the firewall and then install the oil separator and tighten in place. Connect the existing oil separator drain line to the oil separator using the factory clip.

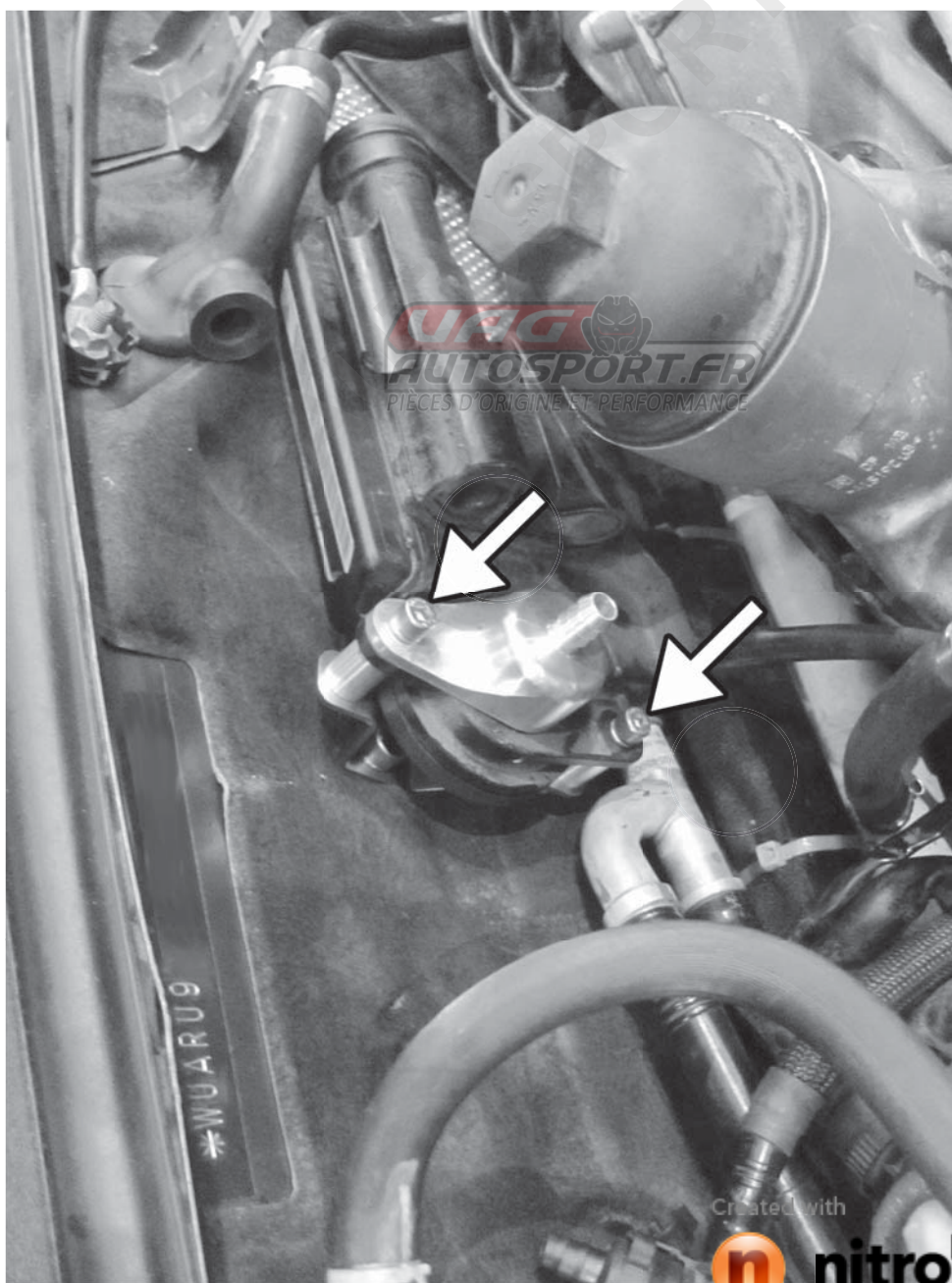

APR, LLC
Alabama 36801
4800 US HWY 280 West Opelika

72) Disconnect the electrical connector to the right side HPFP. Tape the high pressure fuel line connecting nuts up so that they will not slide down the fuel lines. If the intake manifold is on, you will likely have to remove the intake manifold again to retrieve them!

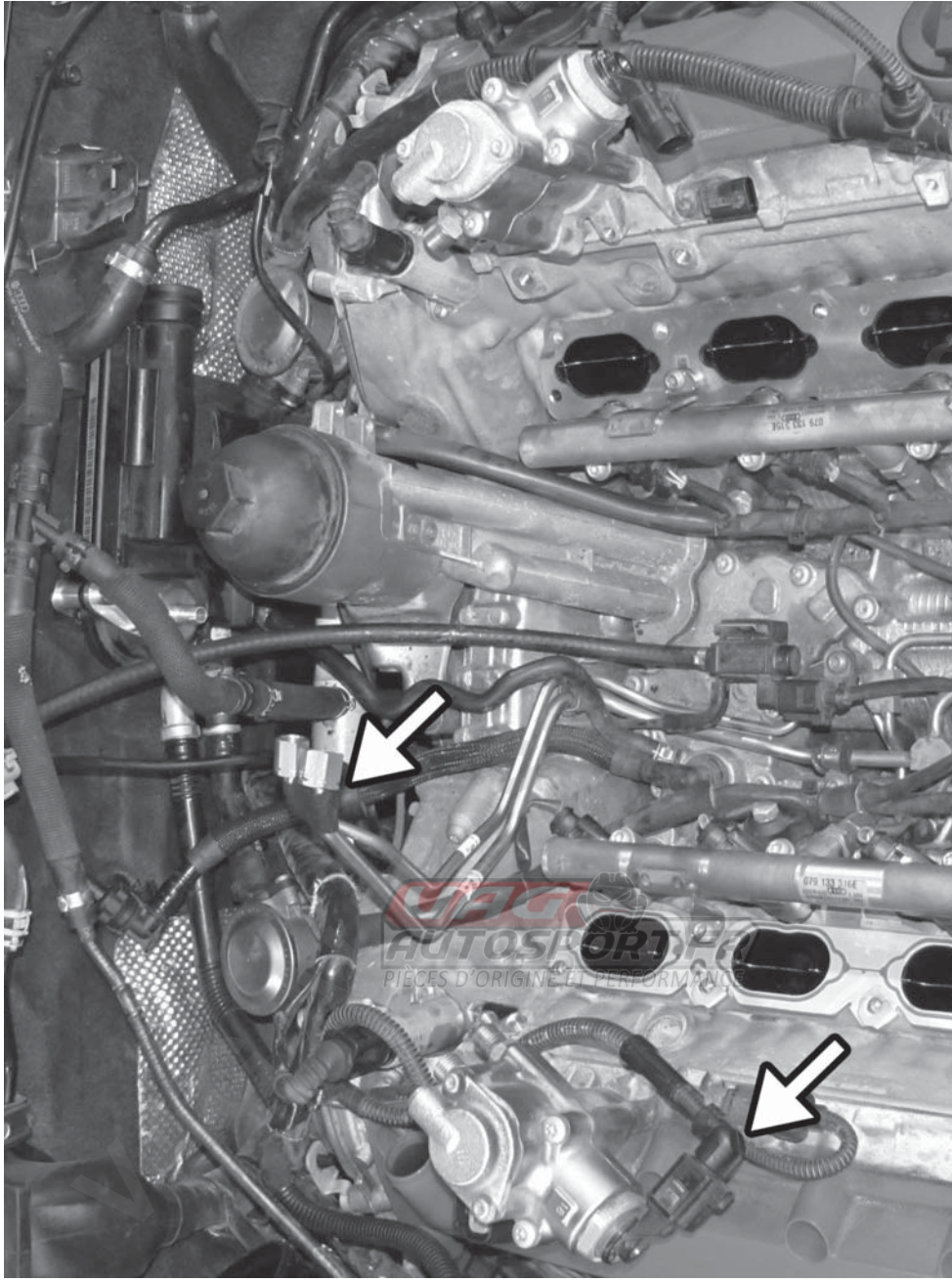

Created with



nitro PDF[®]

professional

download the free trial online at nitropdf.com/professional

APR, LLC
4800 US HWY 280 West Opelika Alabama 36801

73) Reconnect the plastic lines to the combination valves on both sides. Reinstall the T30 torx screw on the left upper water pipe.

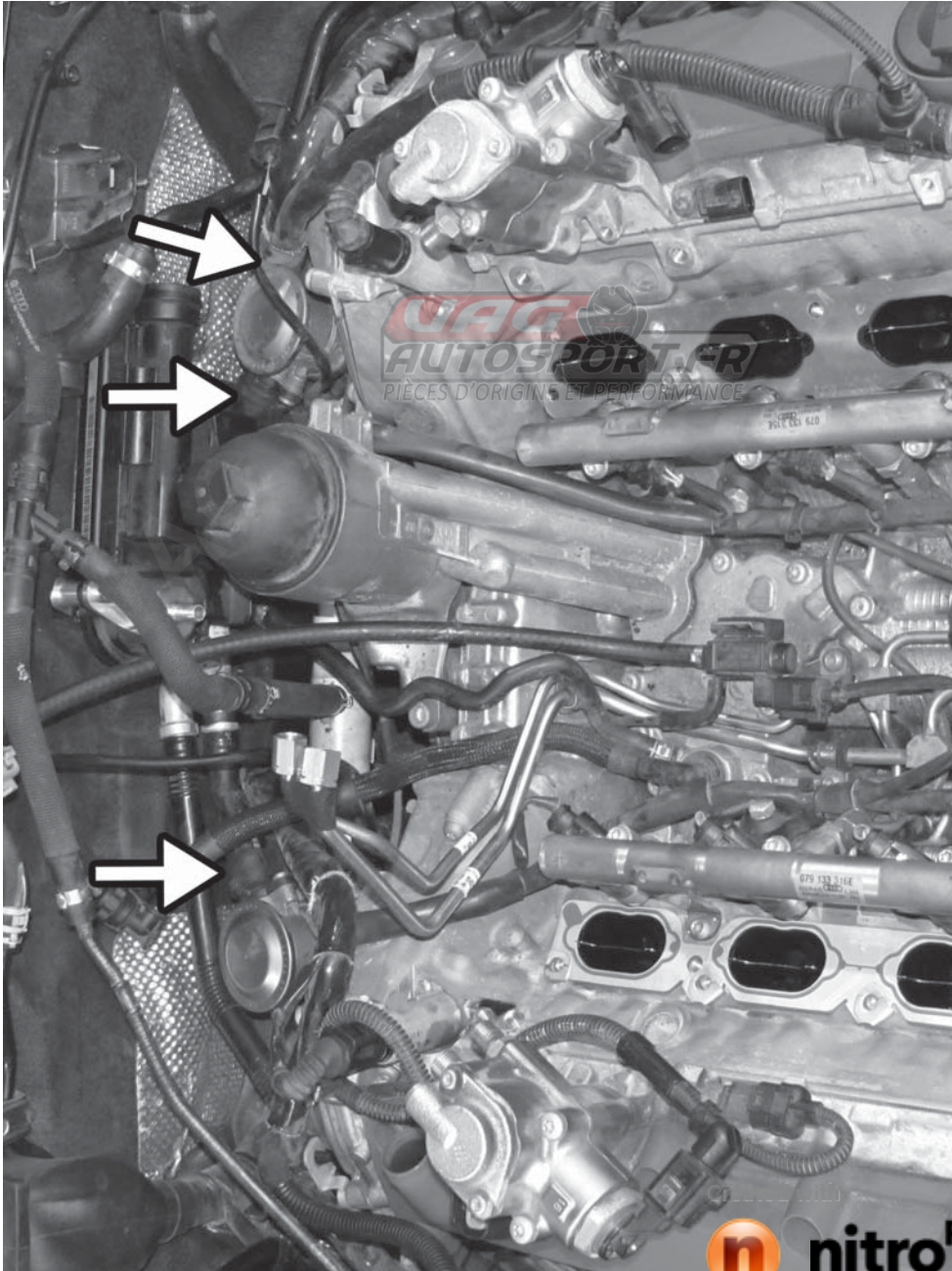

APR, LLC
4800 US HWY 280 West Opelika Alabama 36801

74) Remove the six (three on each side) T30 torx screws from the high pressure fuel pumps and remove the pumps from the car.

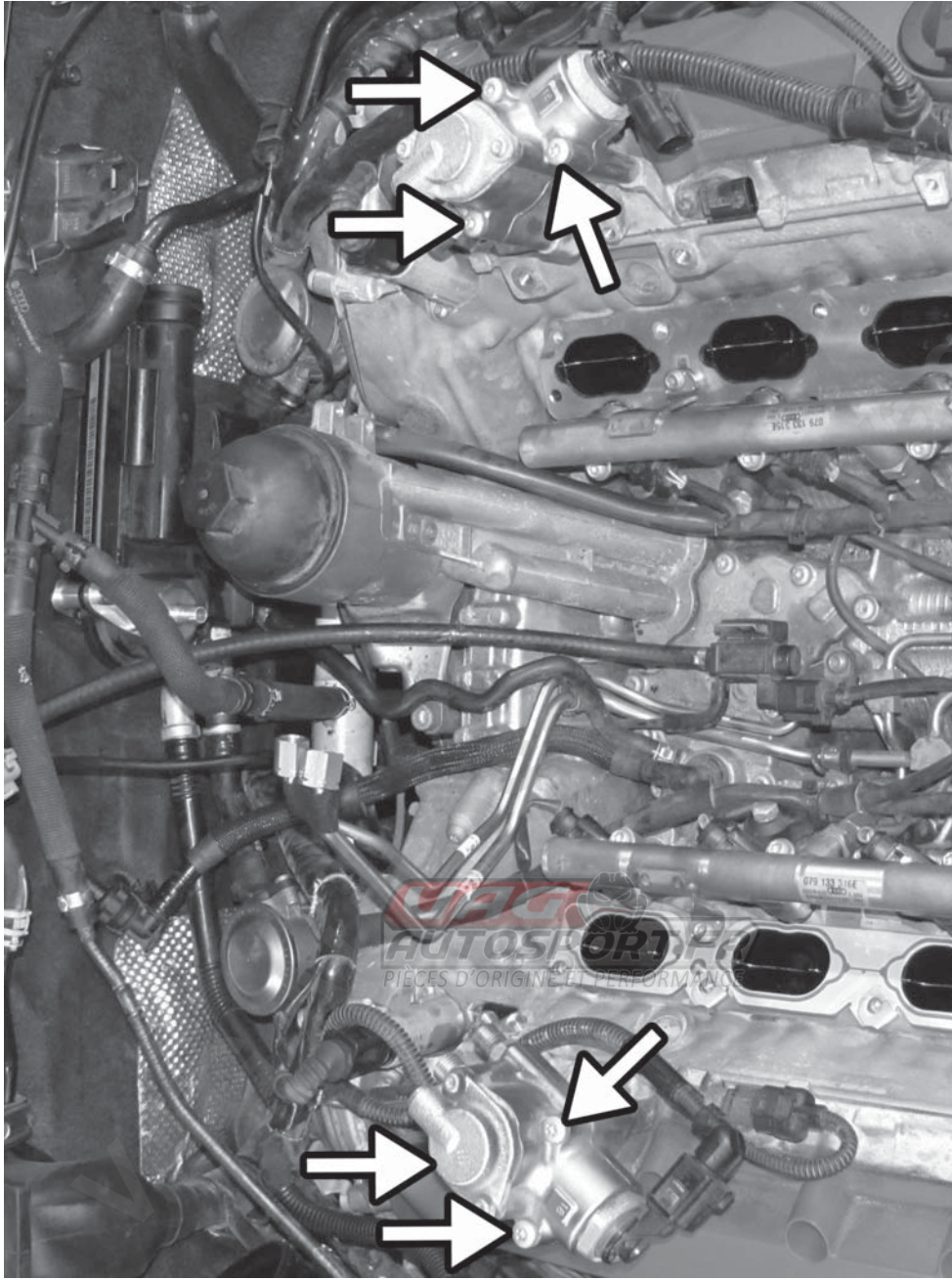

Created with

 **nitro** PDF[®] professional

download the free trial online at nitropdf.com/professional

APR, LLC
4800 US HWY 280 West Opelika Alabama 36801

75) Before installing the supercharger, make sure the low pressure fuel sensor electrical connector is out of the way and the N112 vacuum line is pulled towards the firewall. Wrap the high pressure fuel lines with a clean cloth and cable tie. Install the factory intake manifold gaskets and make sure all debris is out of the crankcase area, including the intake ports.

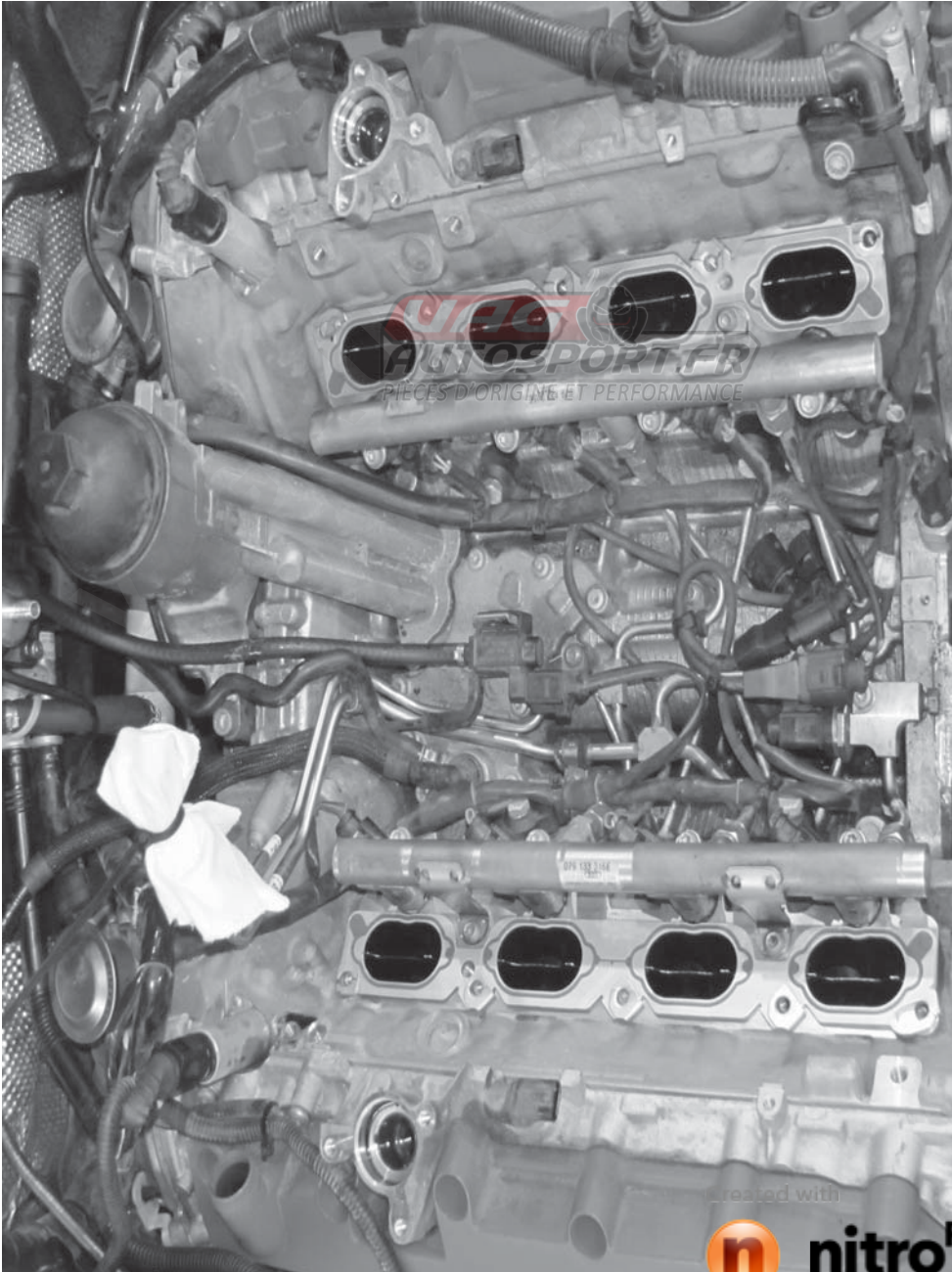

APR, LLC
4800 US HWY 280 West Opelika Alabama 36801

76) Carefully and slowly set the APR supercharger assembly in place, making sure that no lines, especially the ones at the back of the crankcase valley, are pinched. Make sure all electrical connections, like the ones by the #5 fuel injector connector are not crushed. Make sure the coolant line between the water pipe and Y fitting is not pinched or kinked.



Created with



nitro PDF[®]

professional

download the free trial online at nitropdf.com/professional

APR, LLC
4800 US HWY 280 West Opelika Alabama 36801

77) Install the supplied 5MM allen screws and lockwashers with a magnet. Run the screws in all of the way lightly by hand.

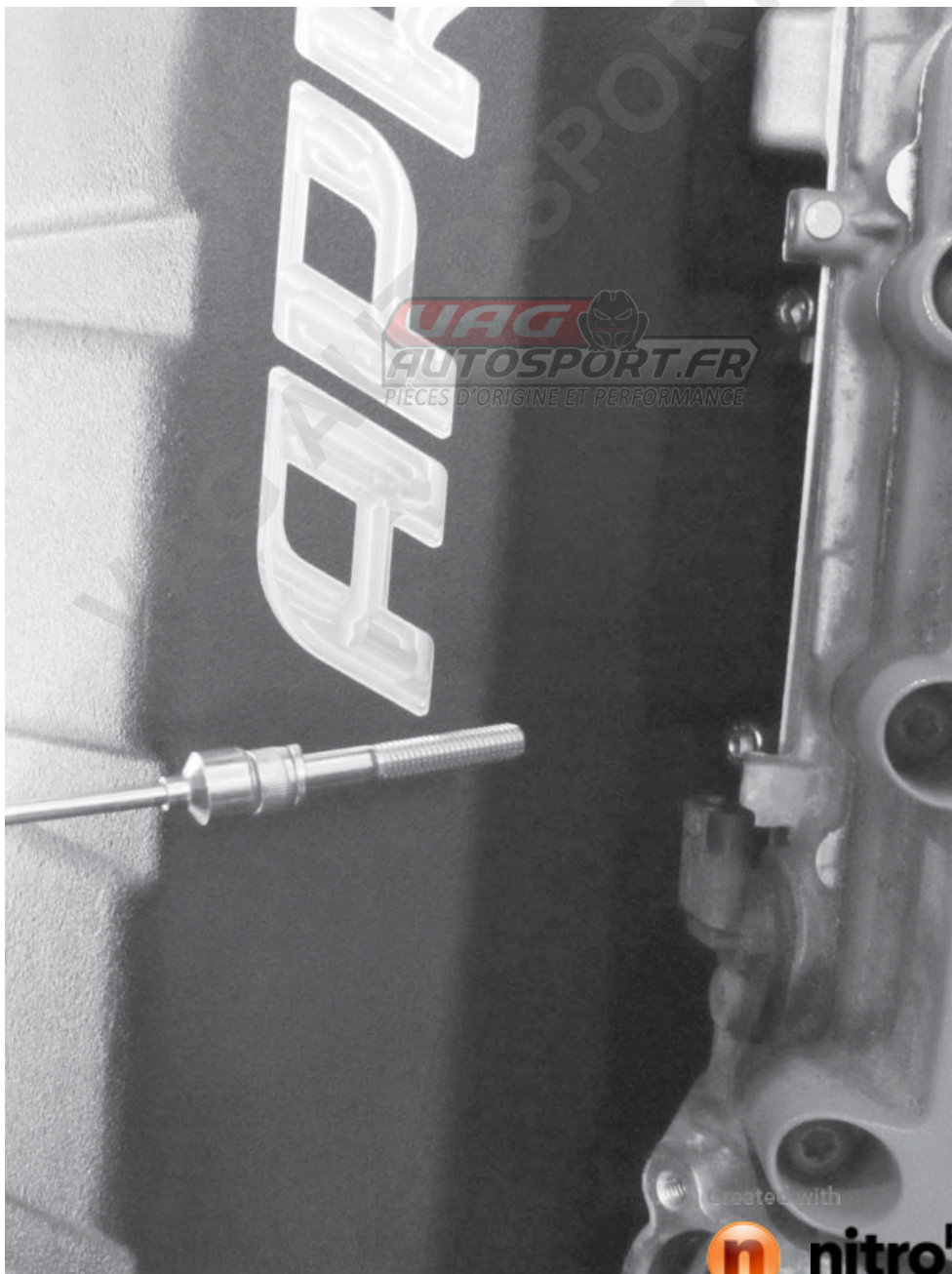

APR, LLC
Alabama 36801
West Opelika
4800 US HWY 280



Created with
nitro PDF

professional

download the free trial online at nitropdf.com/professional

78) Torque the 5MM allen bolts to 85 lb-in in the recommended sequence. Recheck the torque a second time to verify the manifold is torqued correctly. Place a rag or cloth over the APR supercharger to prevent scratches.

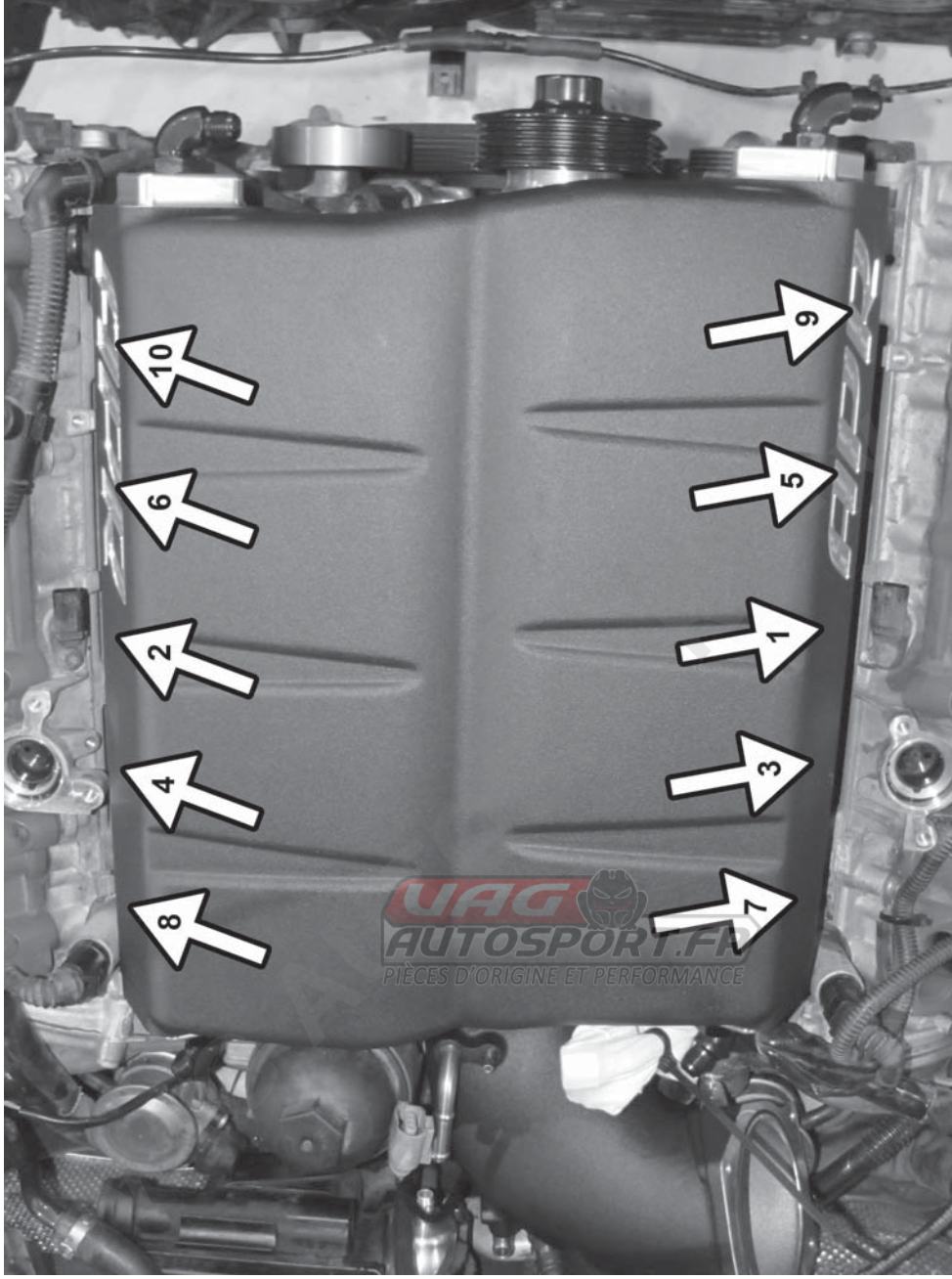

Created with

 **nitro** PDF[®] professional

download the free trial online at nitropdf.com/professional

APR, LLC
4800 US HWY 280 West Opelika Alabama 36801

79) Remove the plastic T-section cover from the upper left side wiring harness and route the harness down between the HPFP mounting flange and the intake manifold. Once in place, reinstall the T-section cover.

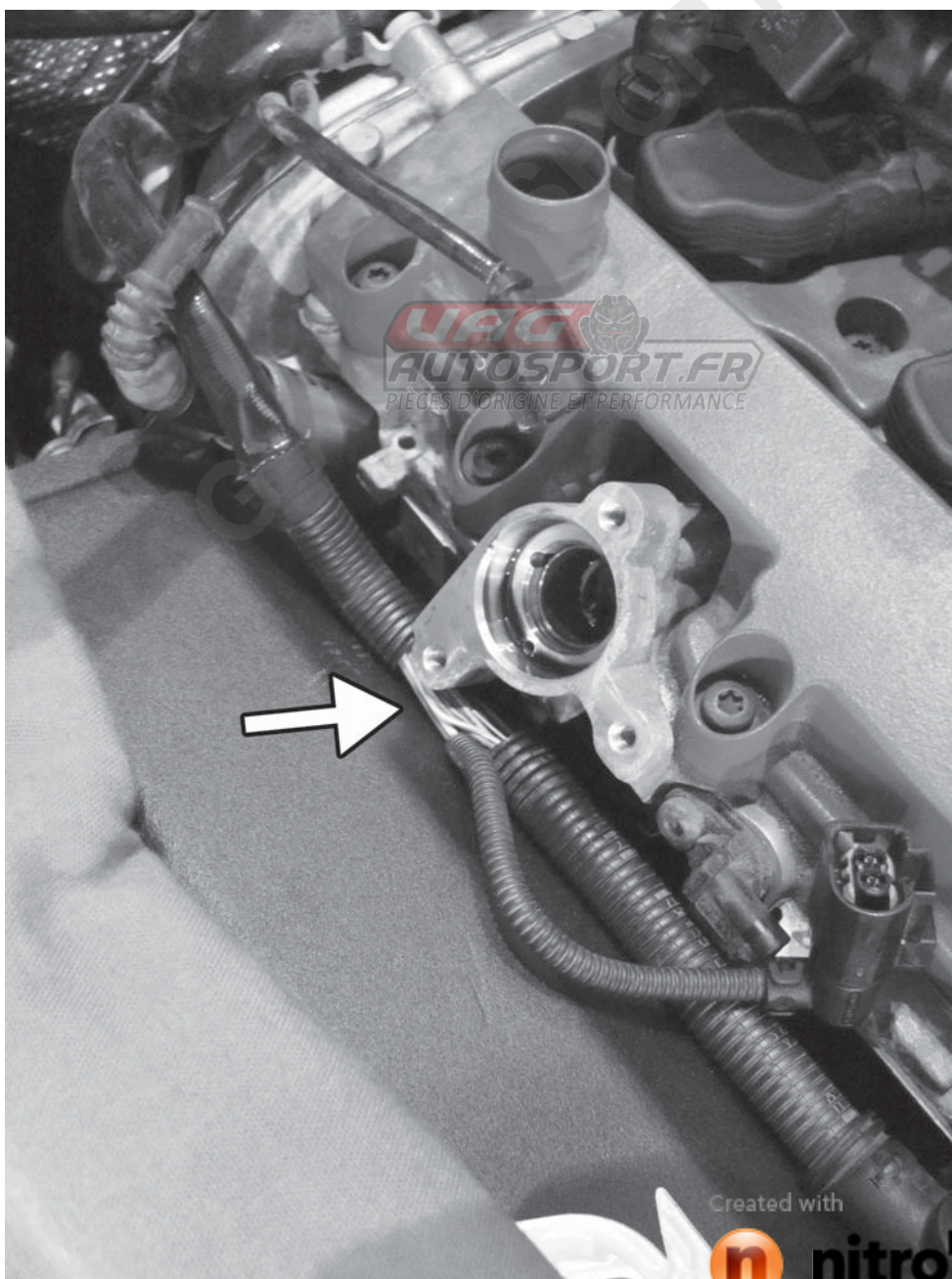

APR, LLC
Alabama 36801
4800 US HWY 280 West Opelika

Created with



nitro PDF

professional

download the free trial online at nitropdf.com/professional

80) Remove the low pressure fittings and internal crush washers from both HPFPs. Reinstall the HPFP's in the car being careful not to pinch the O-ring seal. Torque the T30 torx screws to 18 lb-ft.

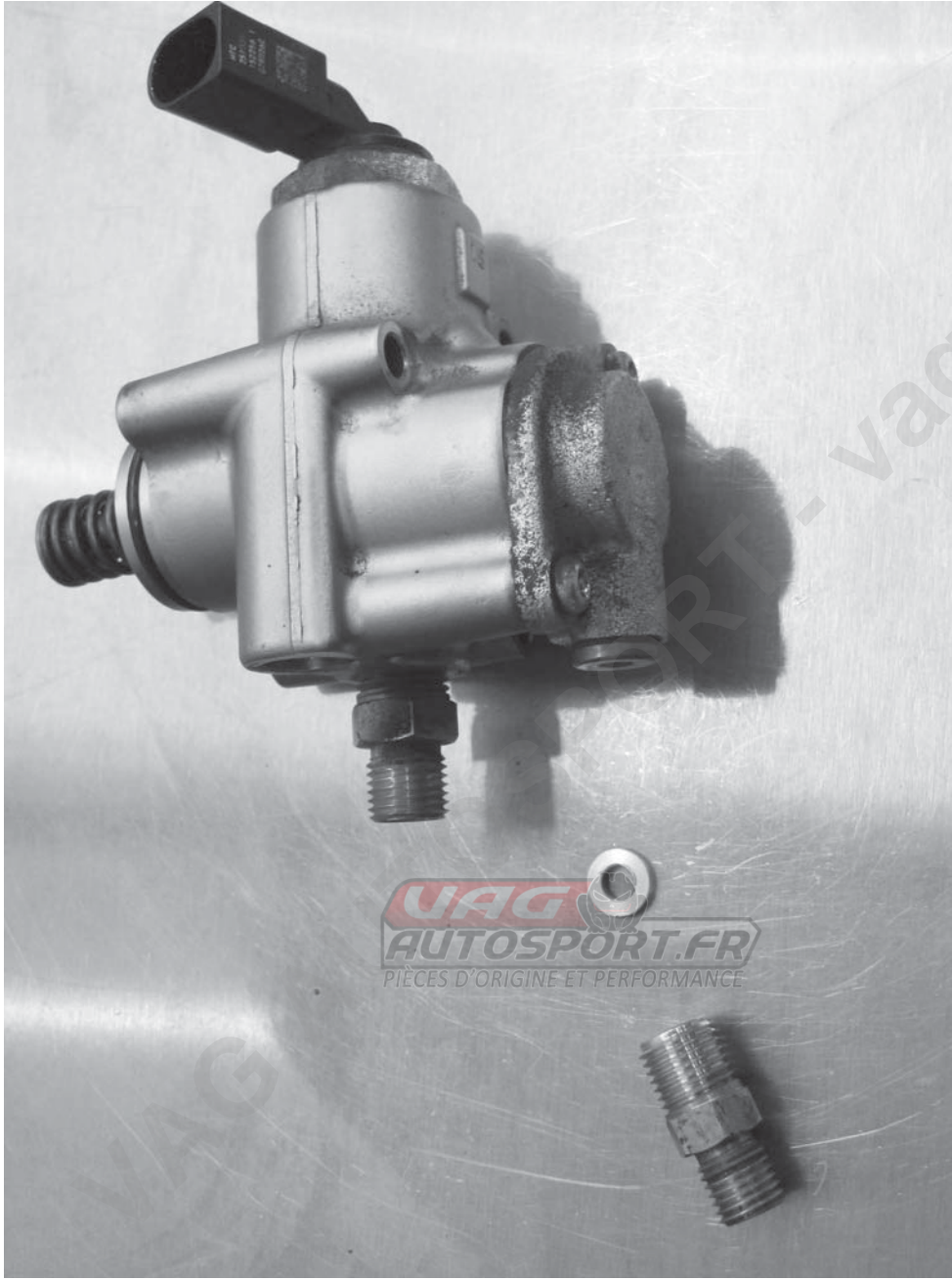

Created with

 **nitro** PDF[®] professional

download the free trial online at nitropdf.com/professional

APR, LLC
4800 US HWY 280 West Opelika Alabama 36801

81) Remove the angled barbed fitting from the stock vacuum line by using a heat gun. It may be necessary to cut the plastic line to remove the stock fitting.

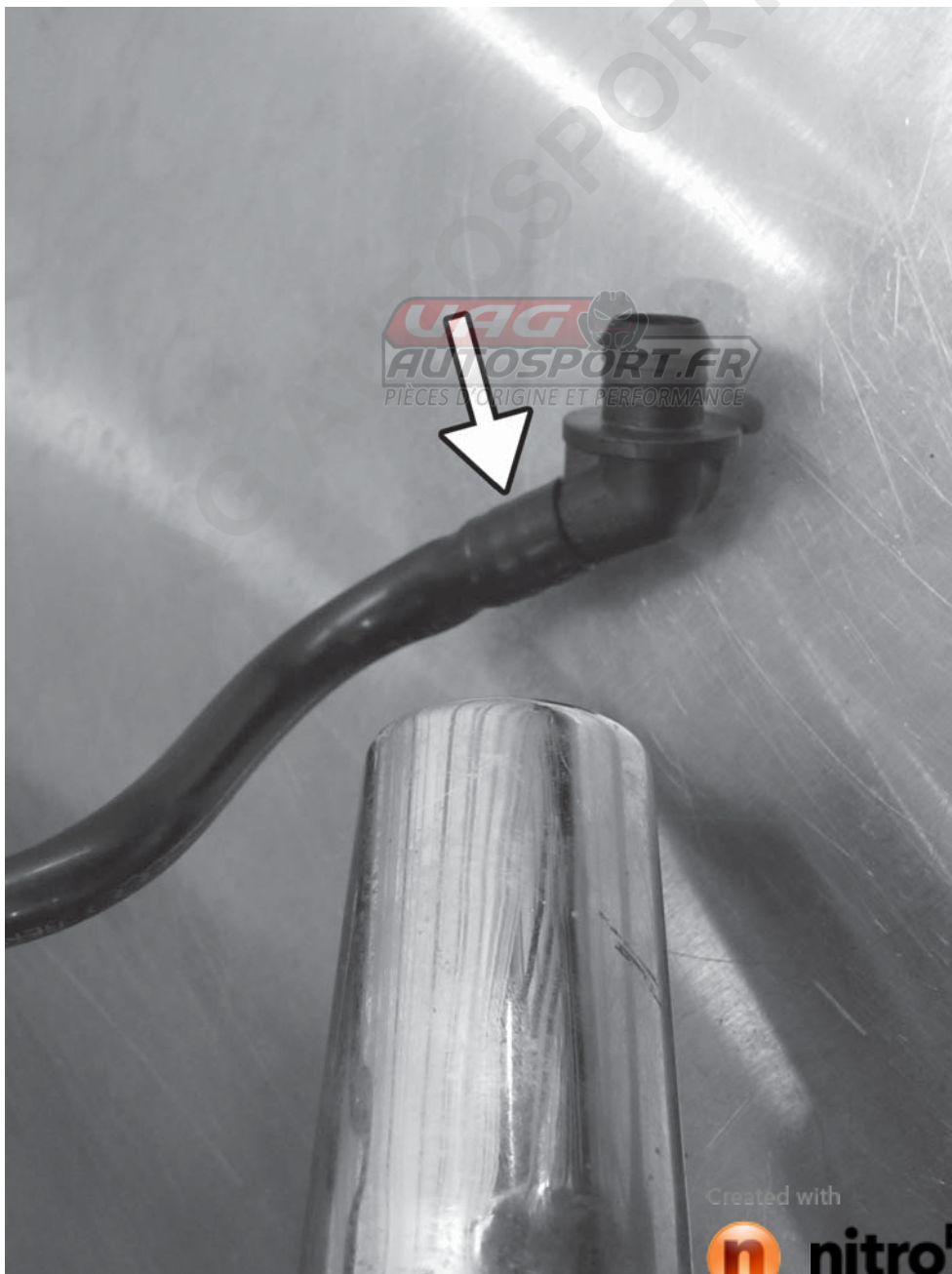

APR, LLC
Alabama 36801
4800 US HWY 280 West Opelika

82) Remove the three vacuum lines from the stock suction jet fitting.

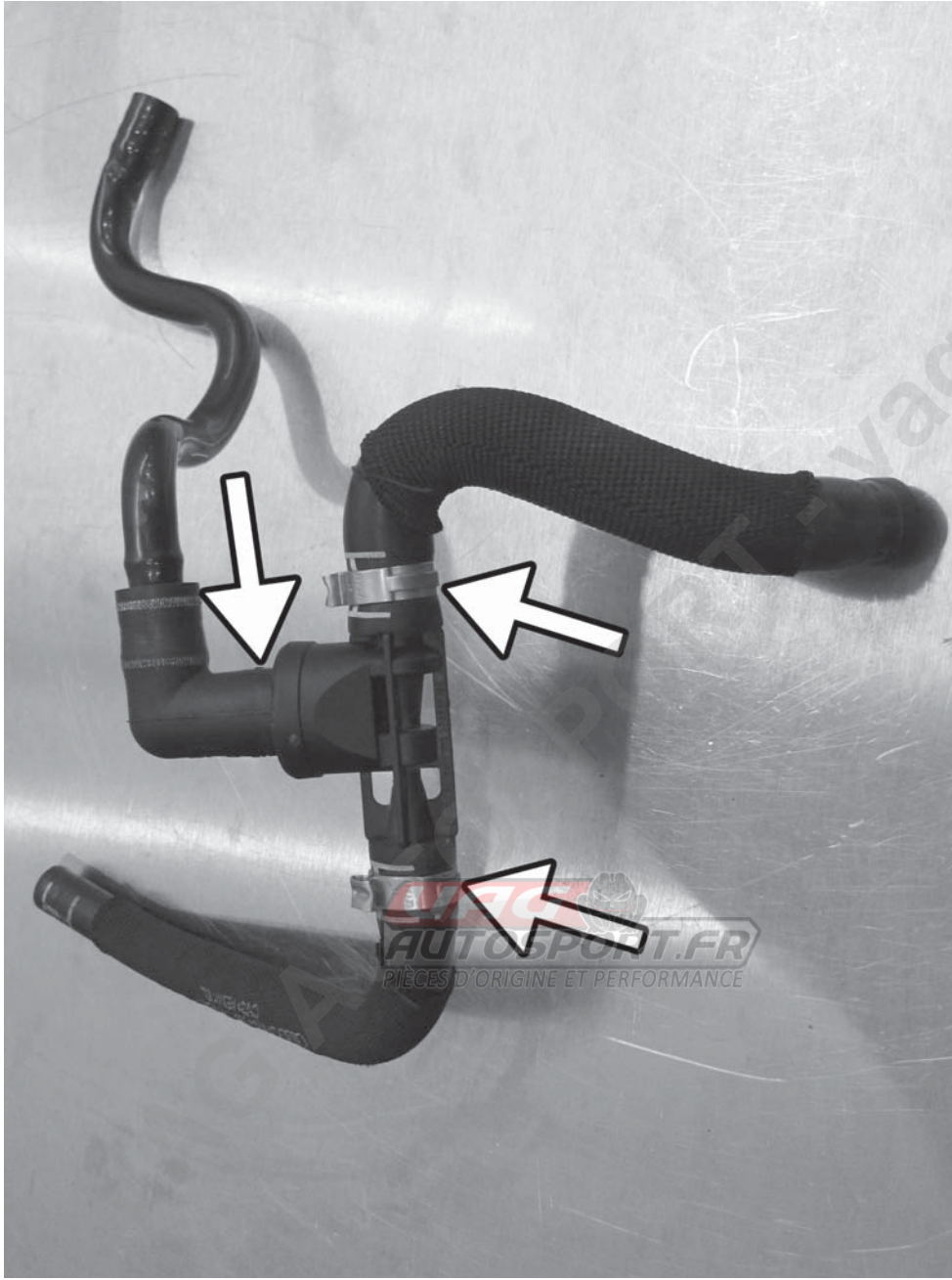

Created with



nitro PDF[®]

professional

download the free trial online at nitropdf.com/professional

APR, LLC
4800 US HWY 280 West Opelika Alabama 36801

83) Using the stock suction jet piece, the previously removed angled barbed fitting, the supplied T fitting, and the supplied 90° fitting, and the supplied vacuum line, make the pictured assembly. Note the orientation of the suction jet fitting. Crimp the clamps to all of the fittings in place using the correct crimp clamp.

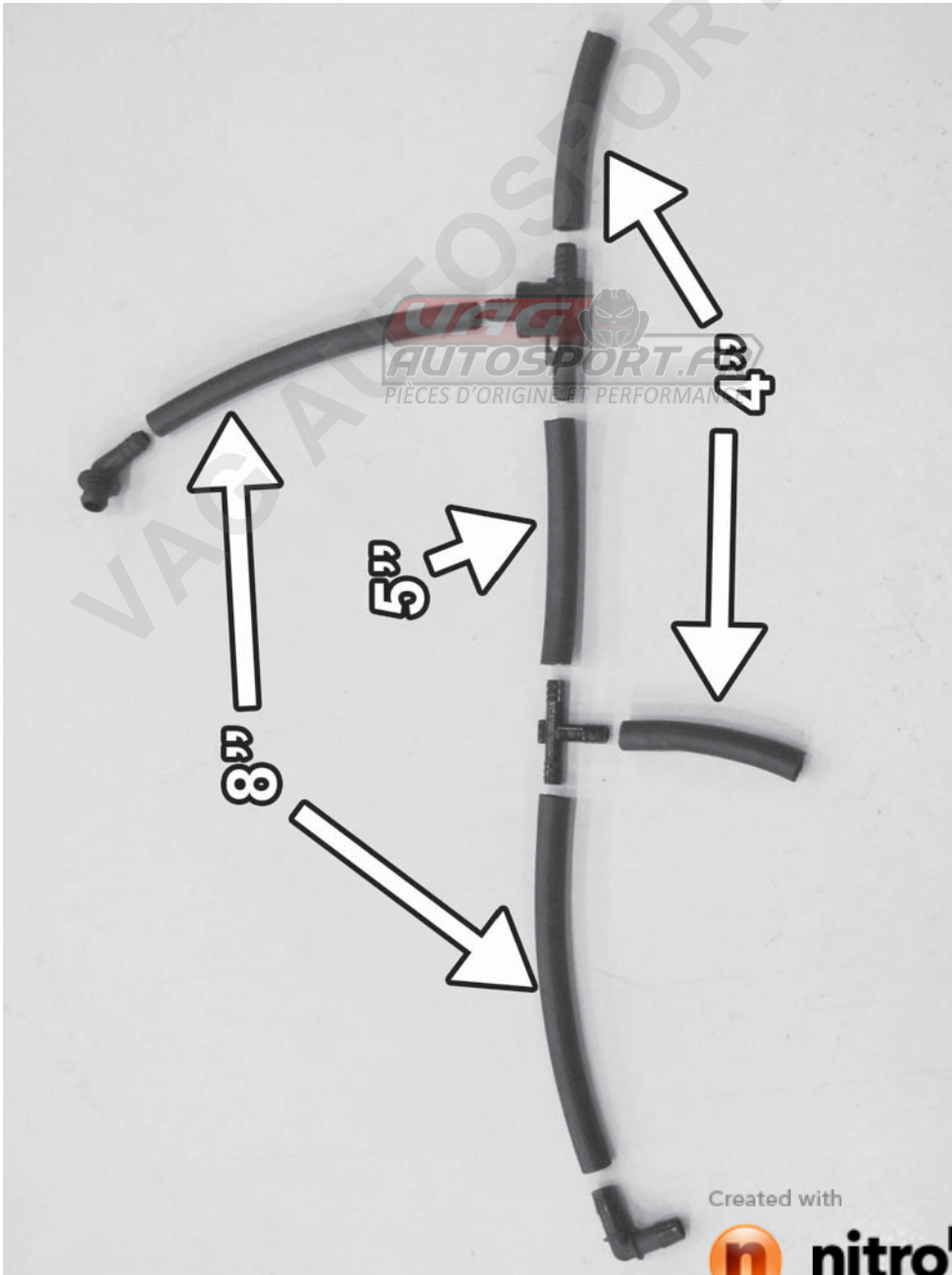

84) Connect the bottom leg of the T fitting to the factory hose that was on the stock throttle body hose.

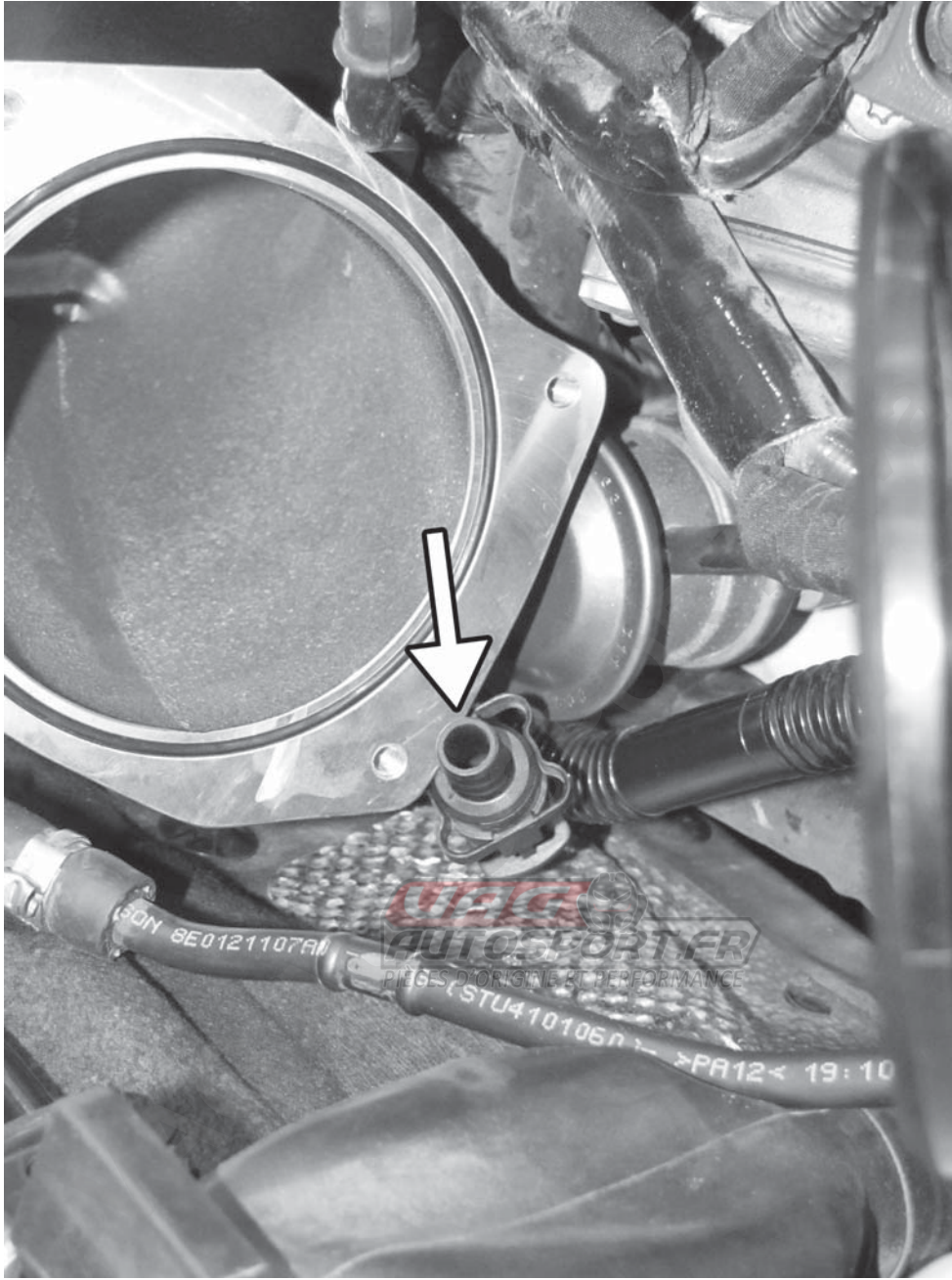

Created with

 **nitro** PDF[®] professional

download the free trial online at nitropdf.com/professional

APR, LLC
4800 US HWY 280 West Opelika Alabama 36801

85) Route the section of the vacuum line assembly with the 90° fitting behind the wiring harness on the firewall.

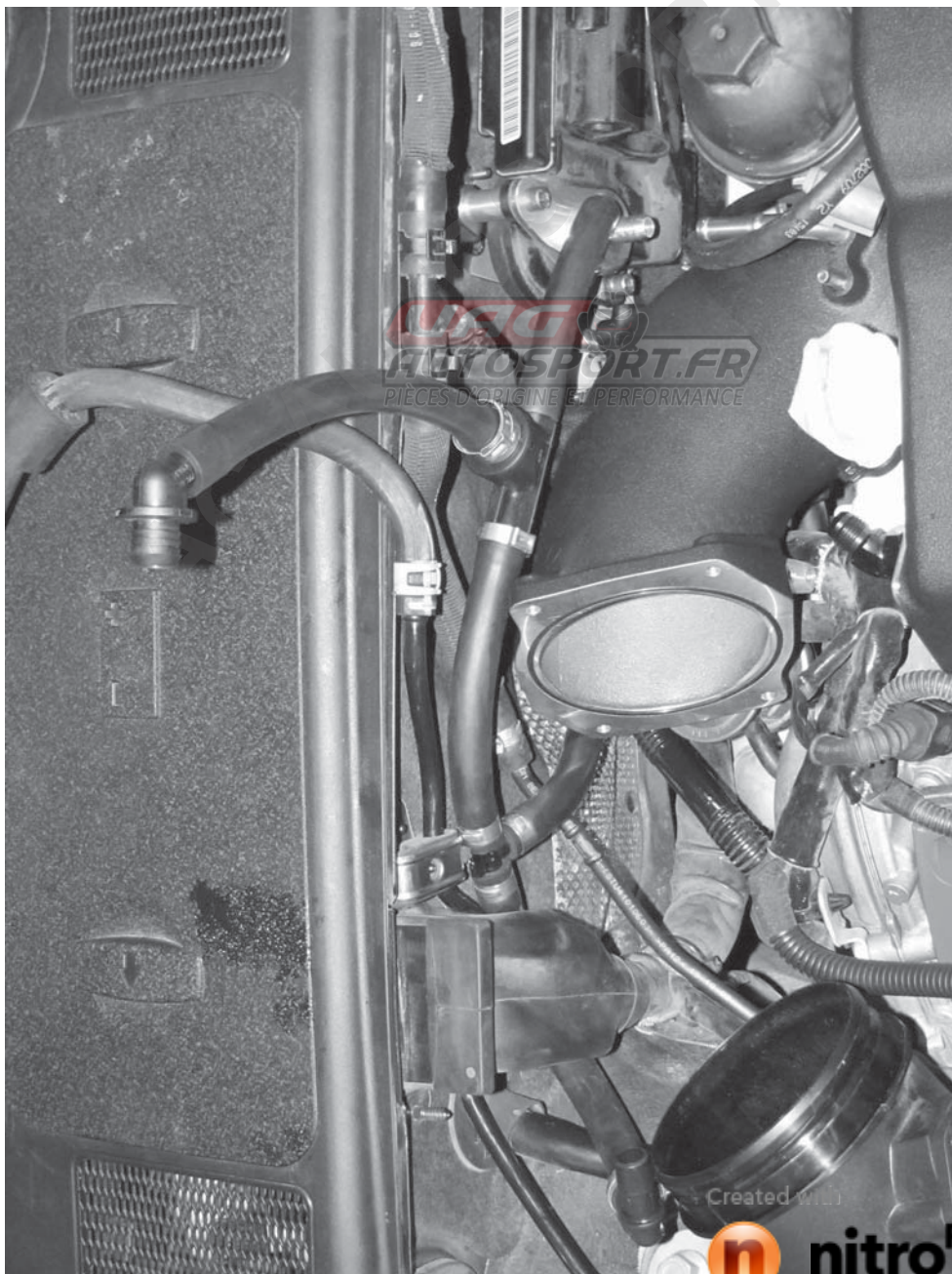

APR, LLC
Alabama 36801
4800 US HWY 280 West Opelika

Created with



nitro PDF

professional

download the free trial online at nitropdf.com/professional

86) Remove the N80 valve from the stock rubber hose. Attach 5" of supplied vacuum line to the side of the N80 with the electrical connector. Attach 19" of vacuum line to the other side of the N80. Secure connections with crimp clamps.



Created with



nitro PDF[®]

professional

download the free trial online at nitropdf.com/professional

APR, LLC
4800 US HWY 280 West Opelika Alabama 36801

87) Connect the short end of the N80 line to the factory plastic N80 line by the airbox. Connect the other end of the line to the angled fitting on the back of the cast inlet elbow, routing the line behind the firewall wiring harness. Also remove the plastic snap from the stock rubber N80 line and attach the new hose to the factory MAF as shown.

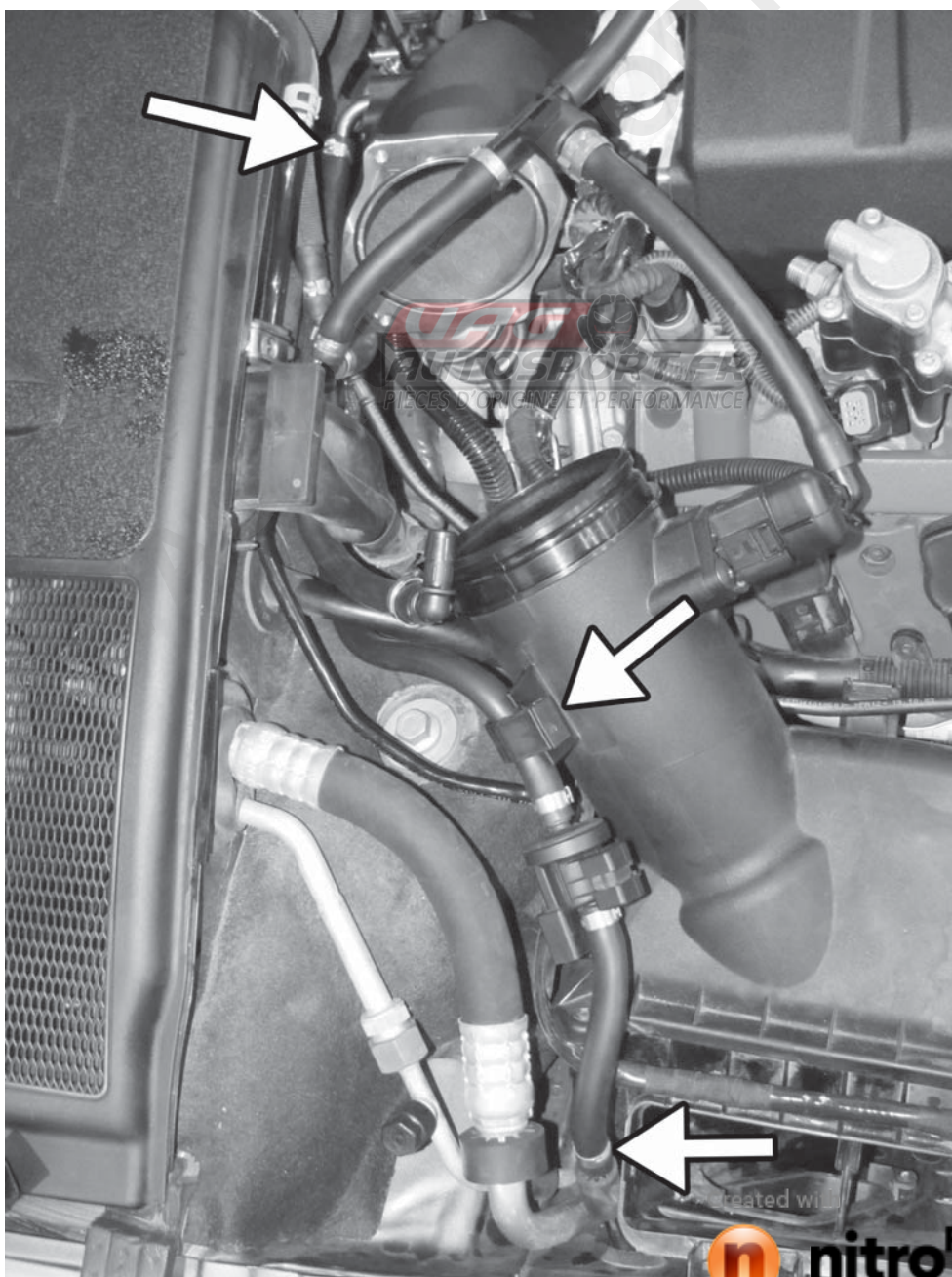

APR, LLC
Alabama 36801
4800 US HWY 280 West Opelika

88) Connect the short section of the suction jet vacuum assembly to the brass fitting on the back of the inlet elbow. Secure with a crimp clamp.

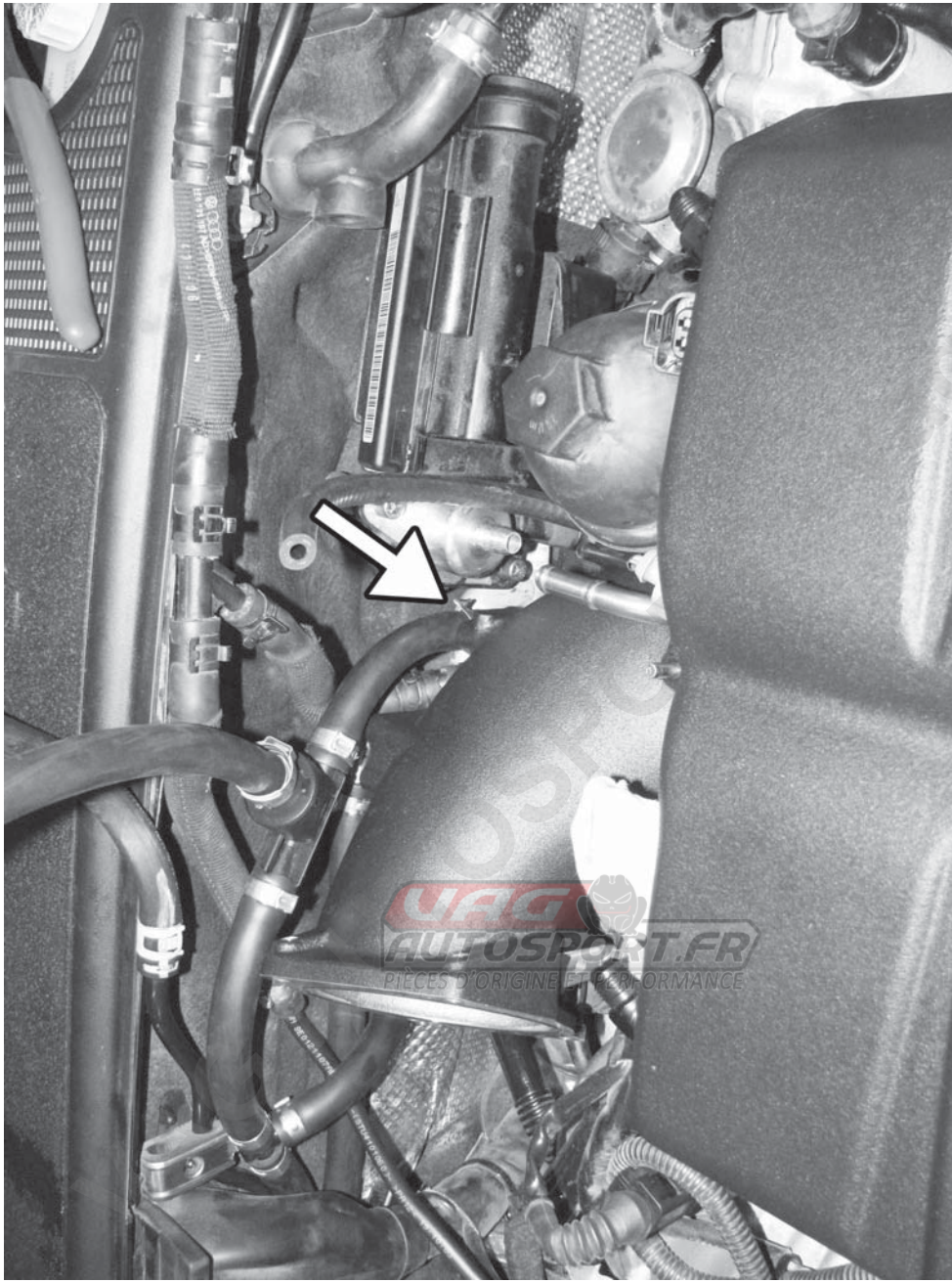

Created with

 **nitro** PDF[®] professional

download the free trial online at nitropdf.com/professional

APR, LLC
4800 US HWY 280 West Opelika Alabama 36801

89) Route the remaining line of the vacuum assembly with the angled barbed fitting behind the Y fitting of the coolant line (between the Y fitting and the firewall) and connect to the brake booster hose.

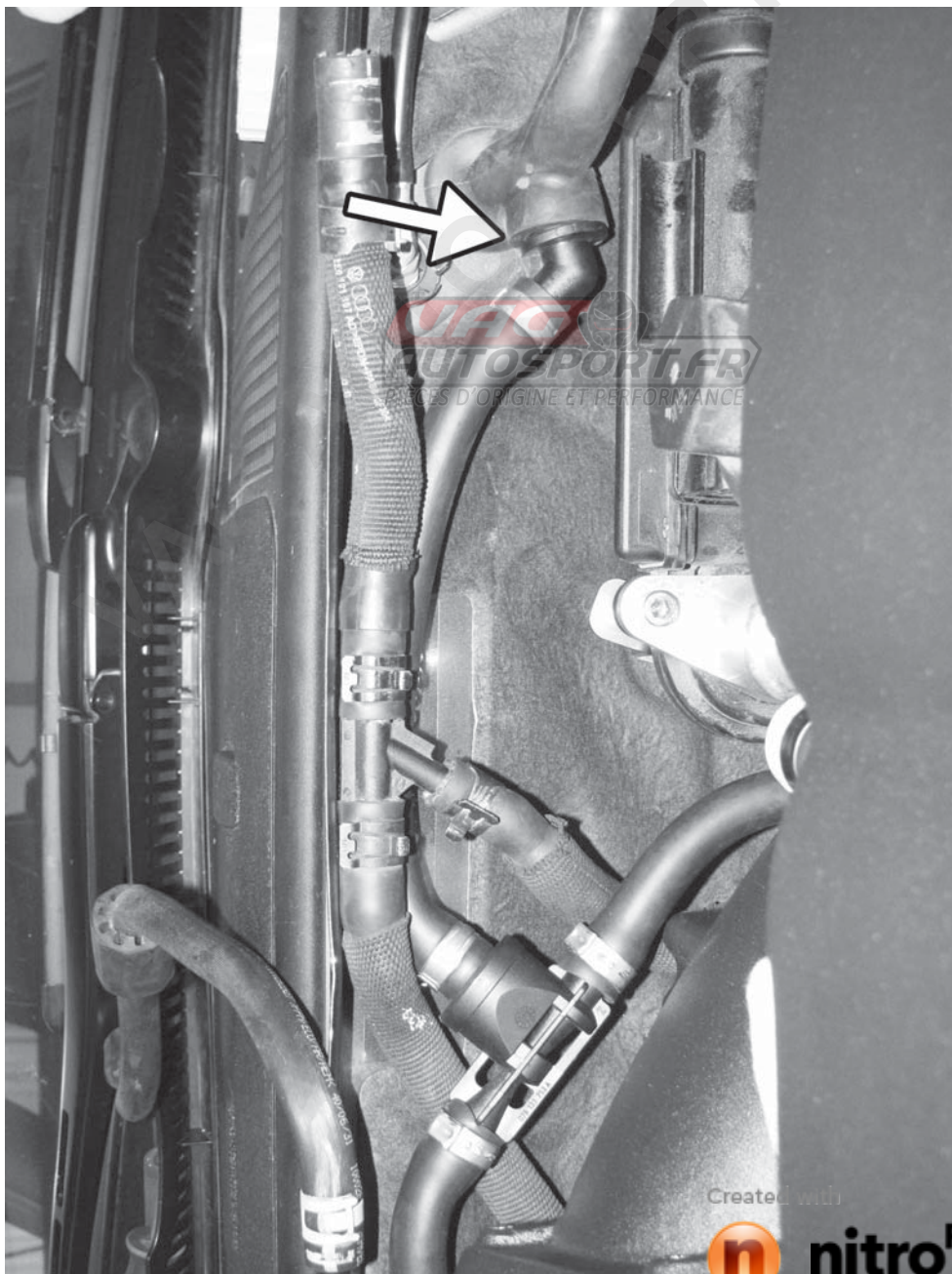

APR, LLC
Alabama 36801
4800 US HWY 280 West Opelika

90) From the front of the engine, remove the rubber line from either side of the four way T fitting. Cut any remaining cable ties still in place to both vacuum lines.

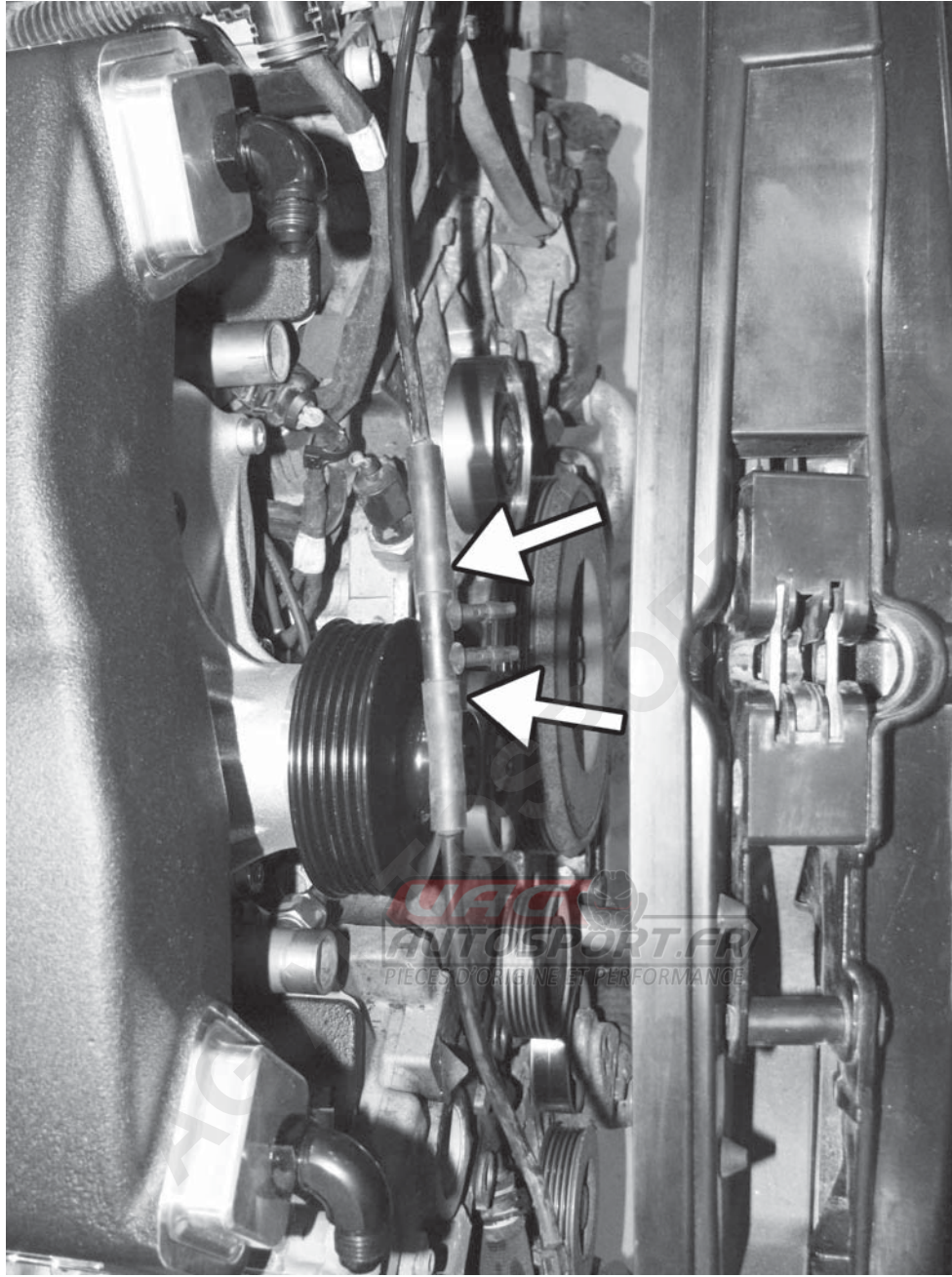

Created with

 **nitro** PDF[®] professional

download the free trial online at nitropdf.com/professional

APR, LLC
4800 US HWY 280 West Opelika Alabama 36801

91) Take the right side vacuum line from the front T fitting around route back towards the back of the engine bay. Connect the line to the top of the airbox with a cable tie, as shown. Remove the short rubber end from the hard plastic line.

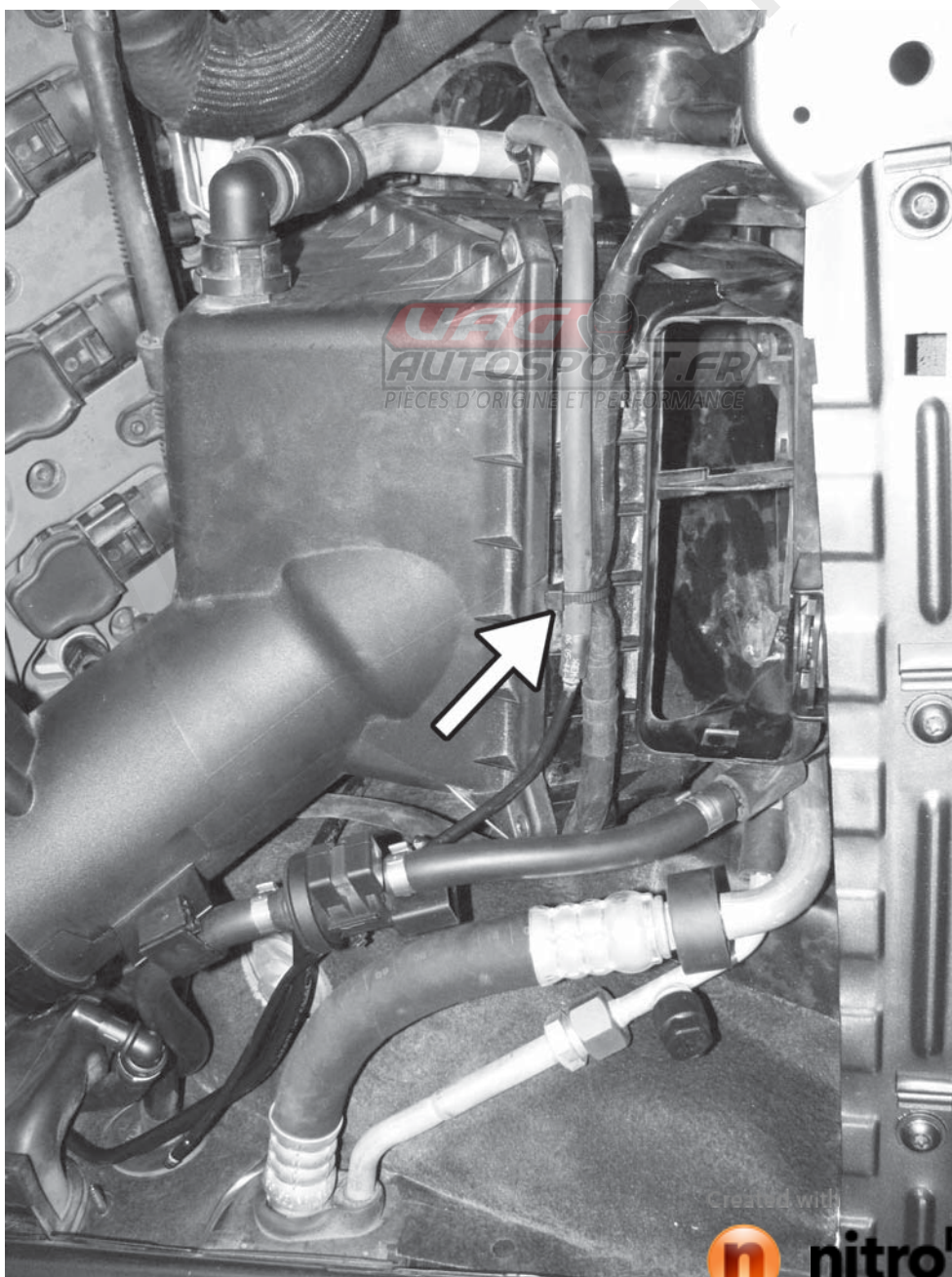

APR, LLC
Alabama 36801
4800 US HWY 280 West Opelika

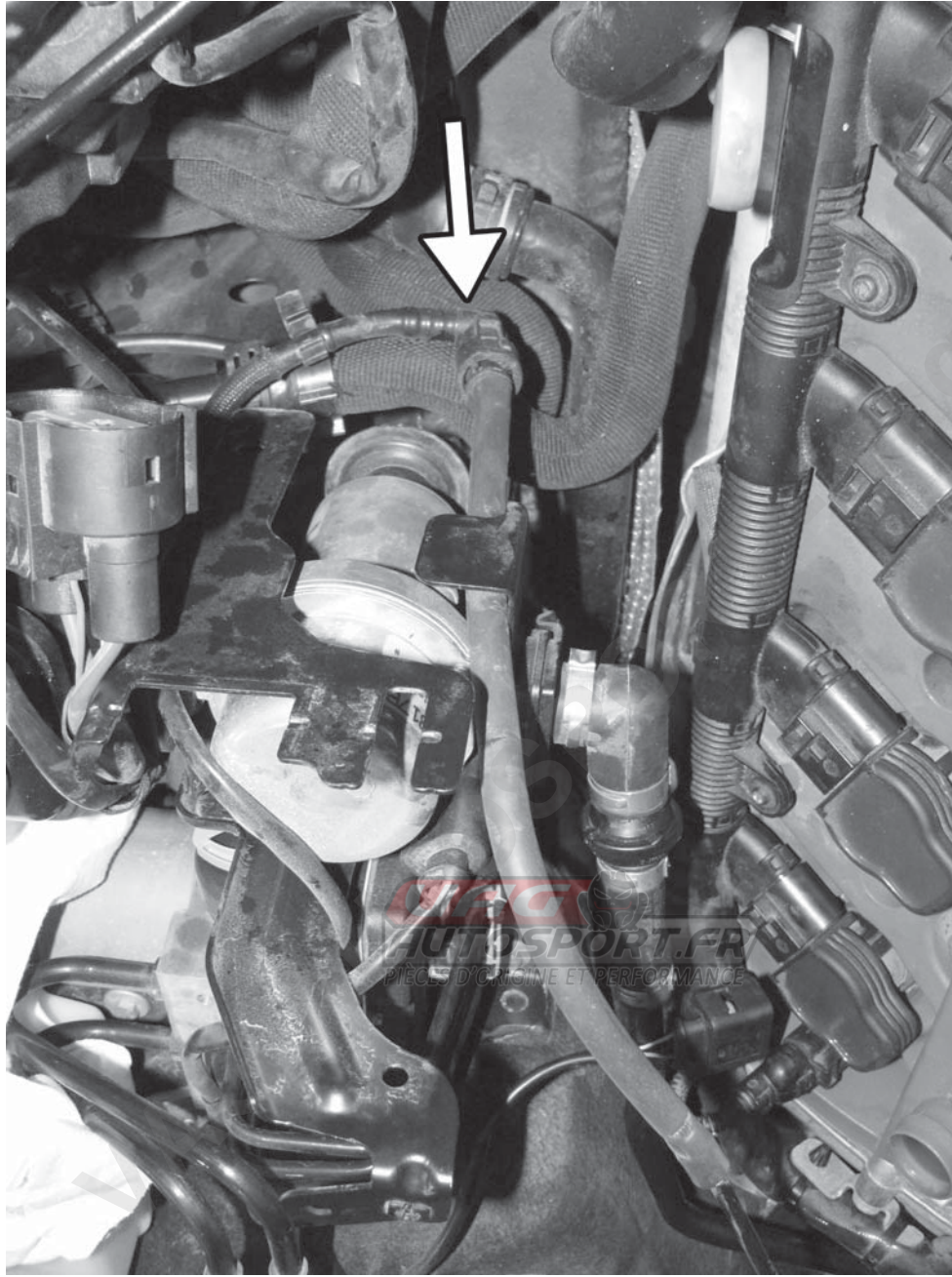

92) Cut the cable tie holding the left side vacuum line from the front T fitting. Bring the line back to the 90° connection and route towards the back of the engine bay as shown. Remove the short rubber end from the hard plastic line.

Created with



nitro PDF[®]

professional

download the free trial online at nitropdf.com/professional

APR, LLC
4800 US HWY 280 West Opelika Alabama 36801

93) Extend both left and right vacuum lines with supplied rubber hose. Route both lines as close to the firewall as possible and out of the way. Install the previously removed T fitting in the two hoses and also connect the previously installed vacuum line from the N112 valve. All vacuum lines may need to be cut to length for a clean installation.

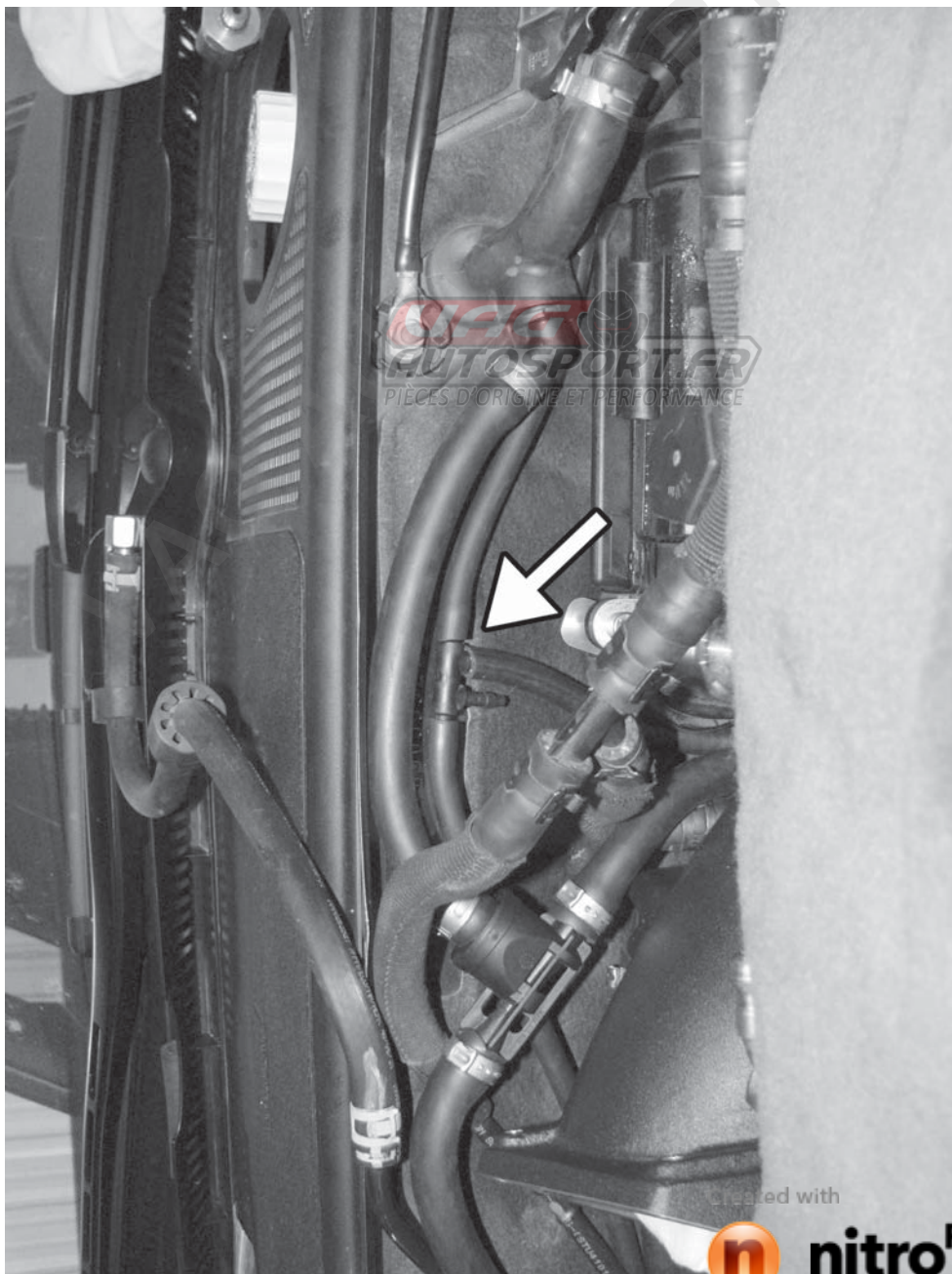

APR, LLC
4 8 0 0 U S H W Y 2 8 0 W e s t O p e l i k a A l a b a m a 3 6 8 0 1

Created with



nitroPDF[®]

professional

download the free trial online at nitropdf.com/professional

94) Install the previously removed check valve and rubber elbow onto the cast inlet elbow. Using the supplied vacuum line, connect the check valve to the last open port of the four way T fitting.

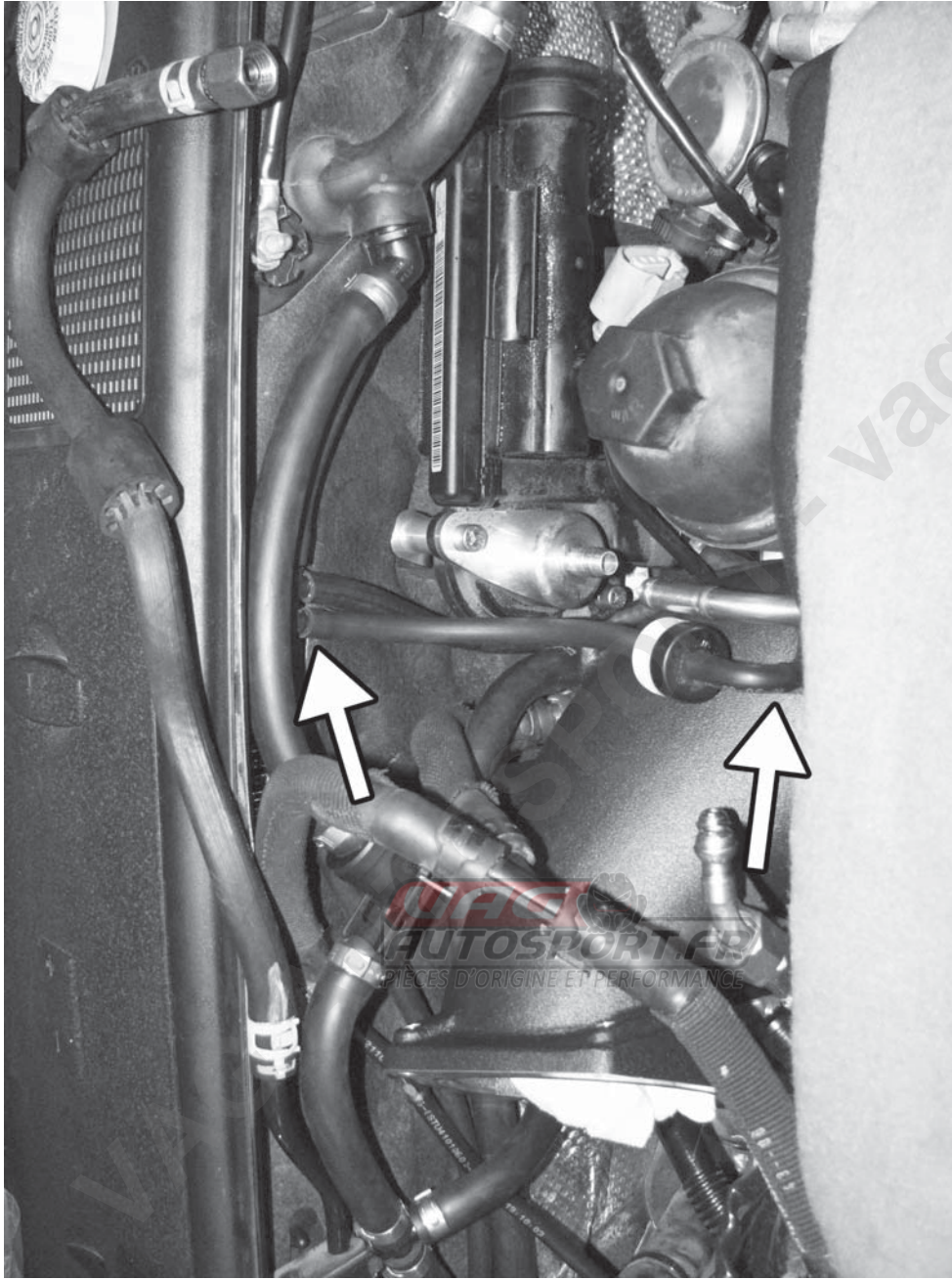

Created with

 **nitro** PDF[®] professional

download the free trial online at nitropdf.com/professional

APR, LLC
4800 US HWY 280 West Opelika Alabama 36801

95) Install 4" of the Norprene vacuum line between the oil separator and the cast inlet elbow fitting with two crimp clamps. Make sure the electrical connector for the low pressure fuel sensor is between the last two installed vacuum lines.

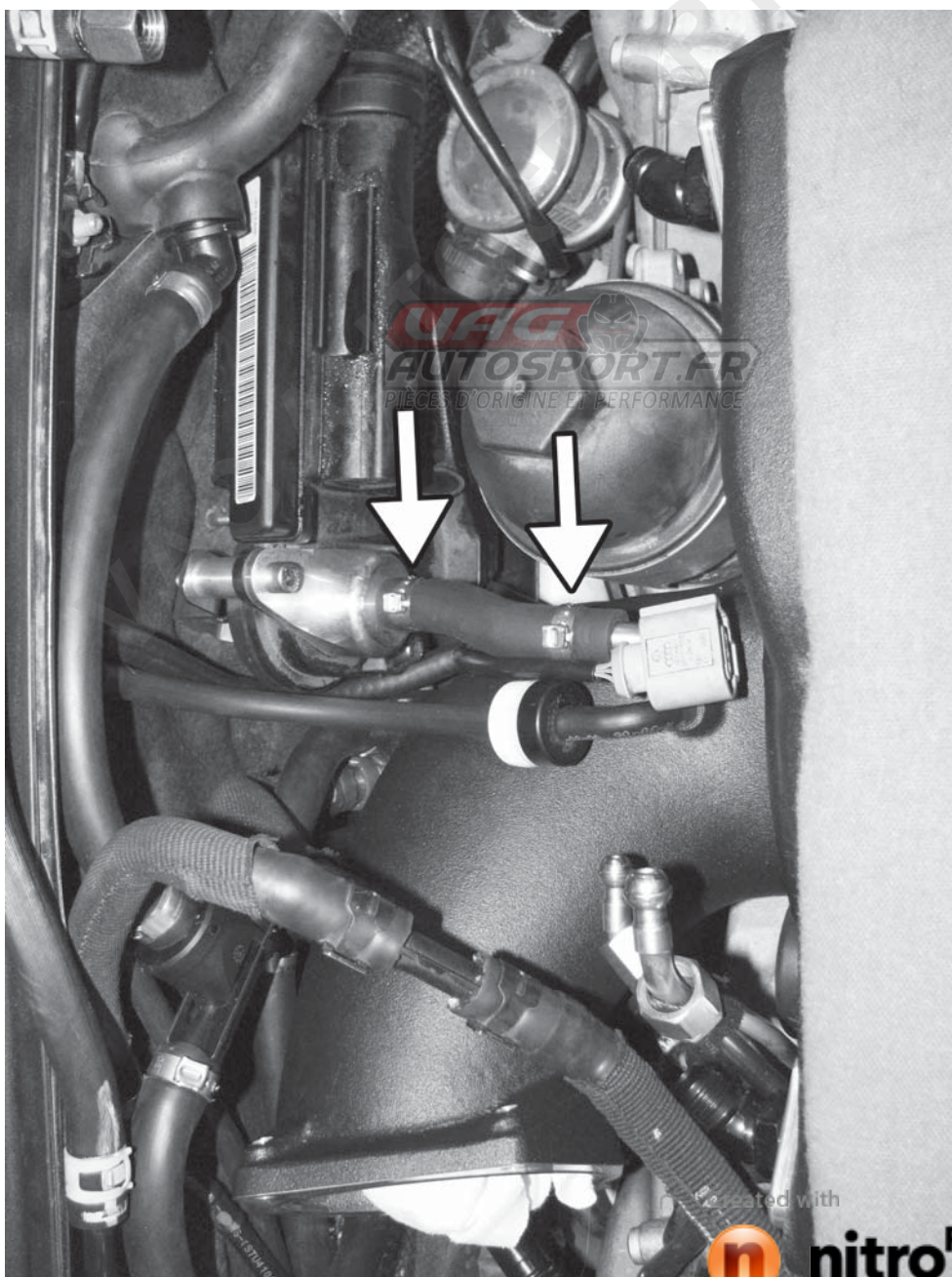

APR, LLC
Alabama 36801
4800 US HWY 280 West Opelika

96) Install the N80 valve wiring extension harness and route approximately along the same path as the N80 vacuum line.

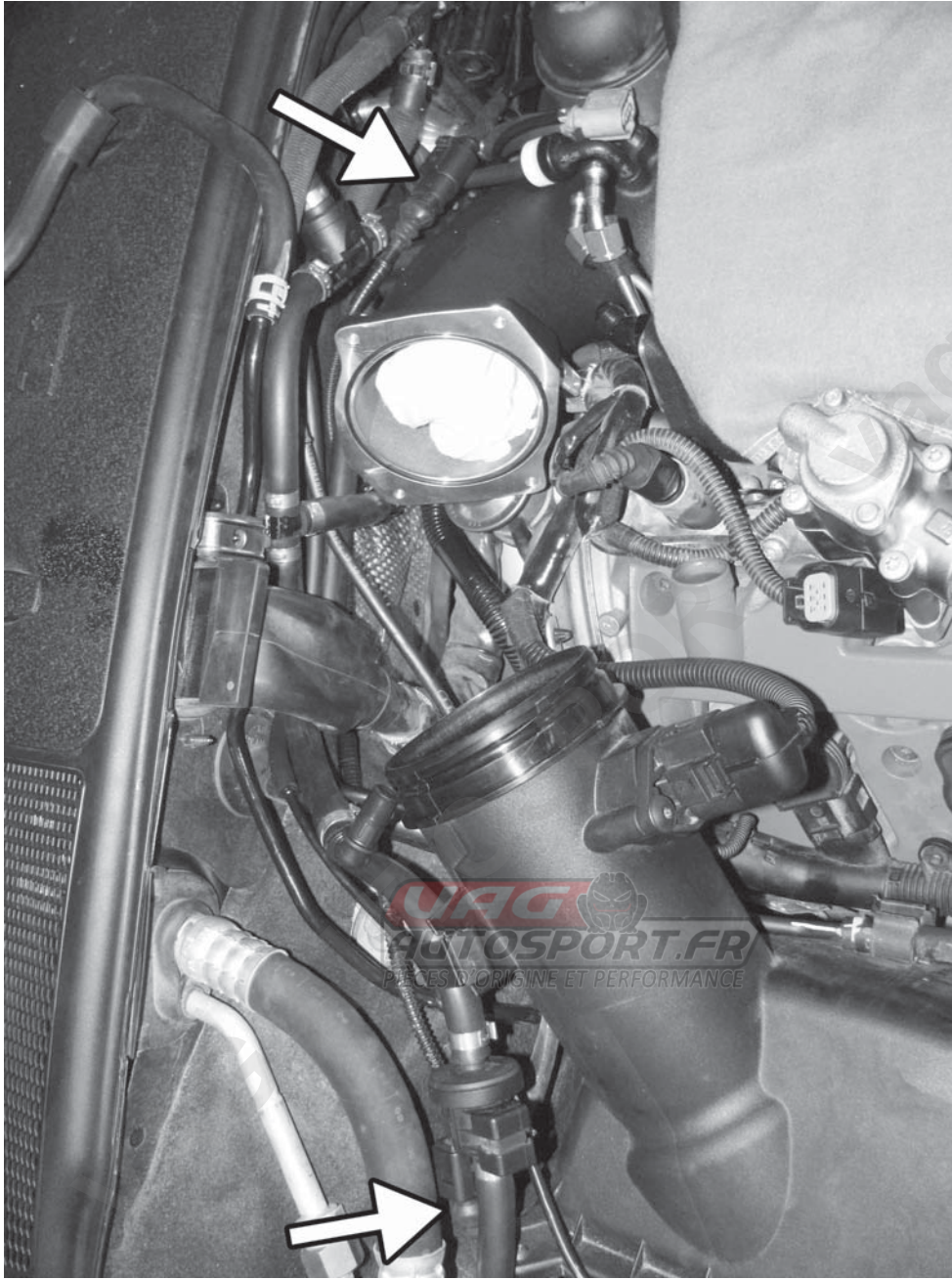

Created with

 **nitro** PDF[®] professional

download the free trial online at nitropdf.com/professional

APR, LLC
4800 US HWY 280 West Opelika Alabama 36801

97) Install the supplied drivebelt with a 3/8" square drive adaptor on the tensioner. Rotate the tensioner clockwise to install the belt, and route the belt as shown in the image.

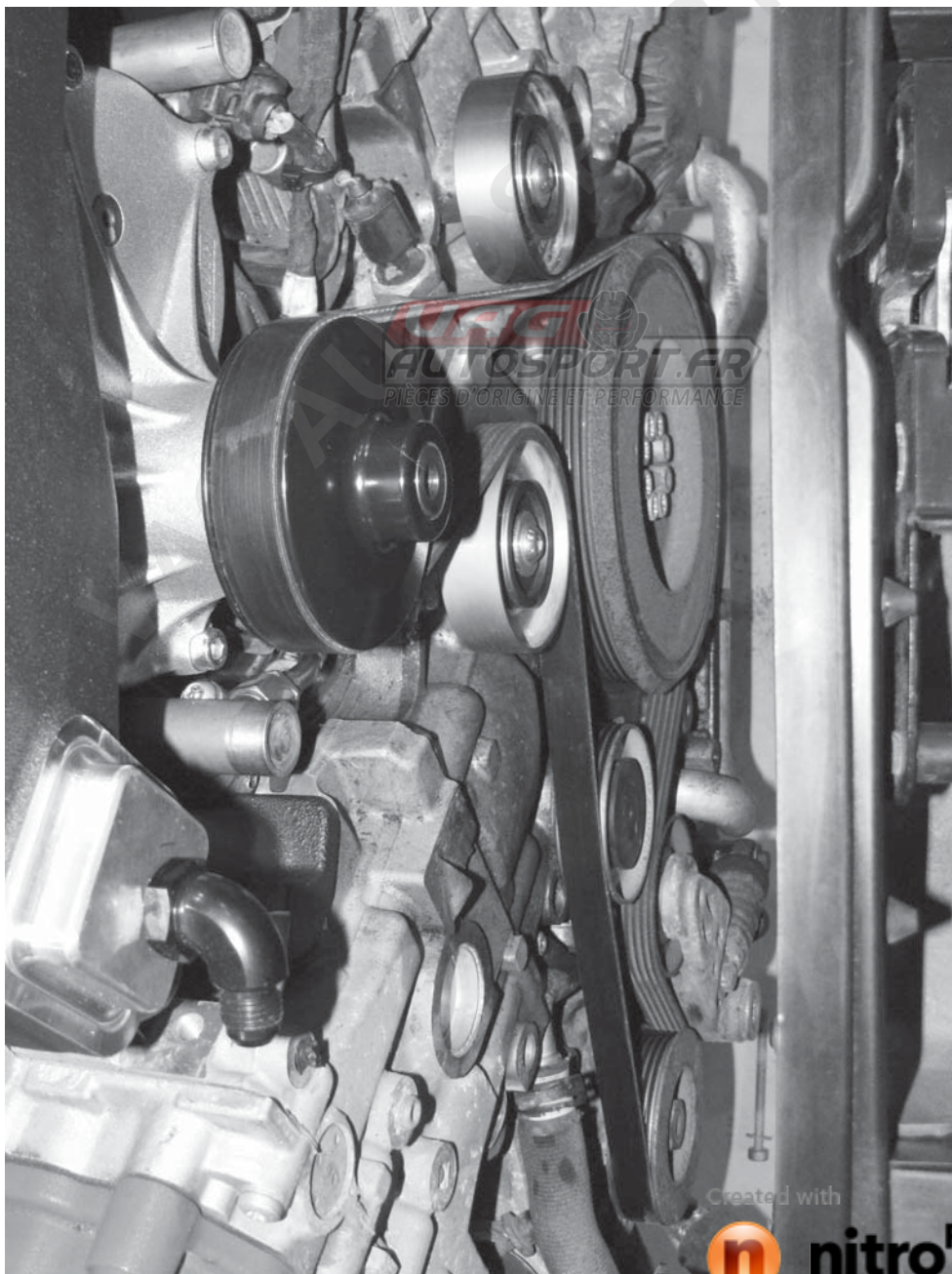

APR, LLC
4800 US HWY 280 West Opelika Alabama 36801

Created with



nitro PDF[®]

professional

download the free trial online at nitropdf.com/professional

98) Slide the radiator core support back to its original location. Install the six (three on each side) 13MM mounting screws.

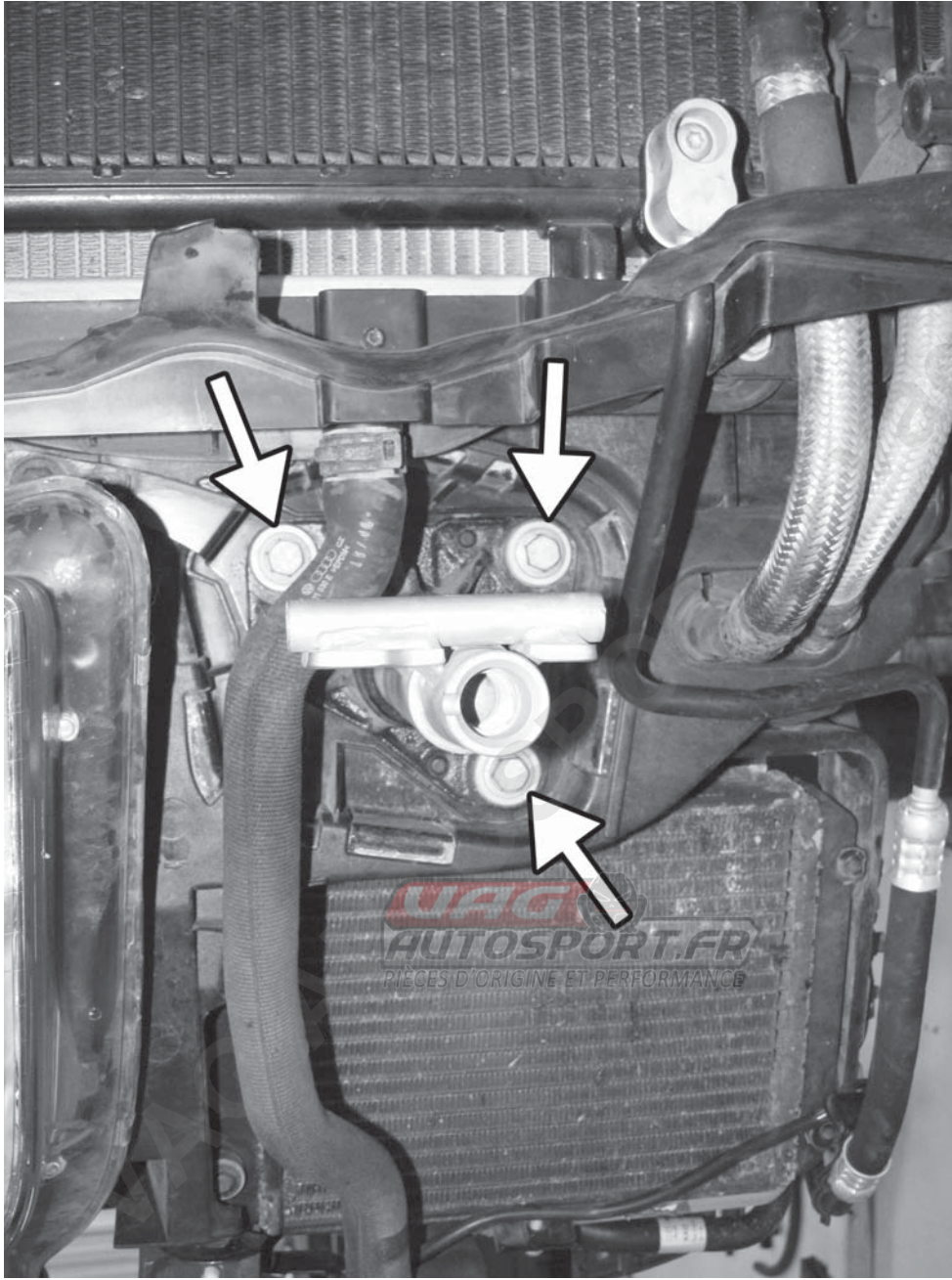

Created with



nitroPDF[®]

professional

download the free trial online at nitropdf.com/professional

APR, LLC
4800 US HWY 280 West Opelika Alabama 36801

99) Reinstall the two (one on each side) T30 torx screws that connect the core support to the fender of the car.

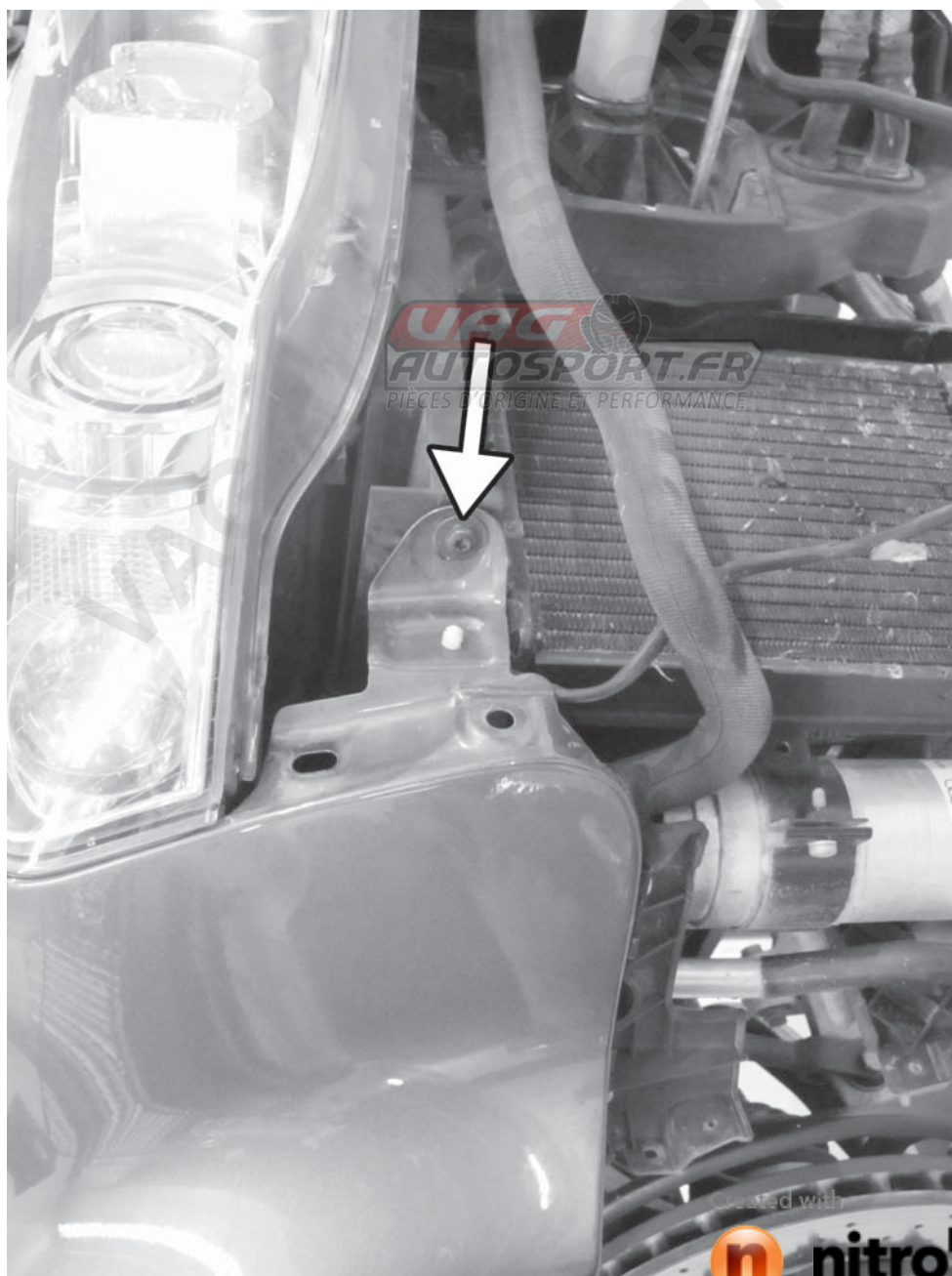

APR, LLC
Alabama 36801
4800 US HWY 280 West Opelika



nitro PDF

professional

download the free trial online at nitropdf.com/professional

100) Reinstall the four (two on each side) T30 torx screws that connect the upper portion of the core support to the front fender.

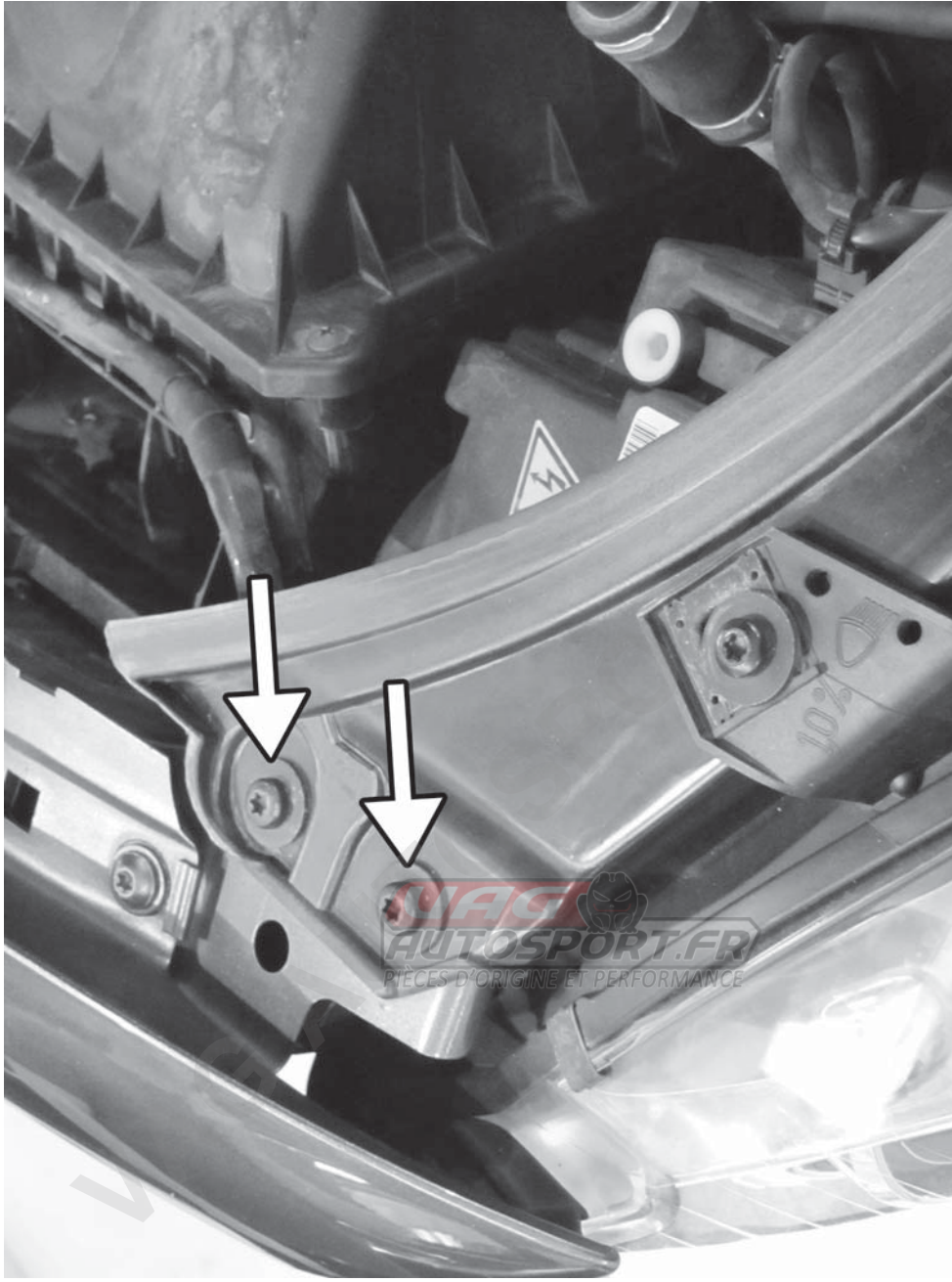

Created with

 **nitro** PDF[®] professional

download the free trial online at nitropdf.com/professional

APR, LLC
4800 US HWY 280 West Opelika Alabama 36801

101) Reinstall the 10MM screw that holds the side radiator mounting tab to the radiator core support.

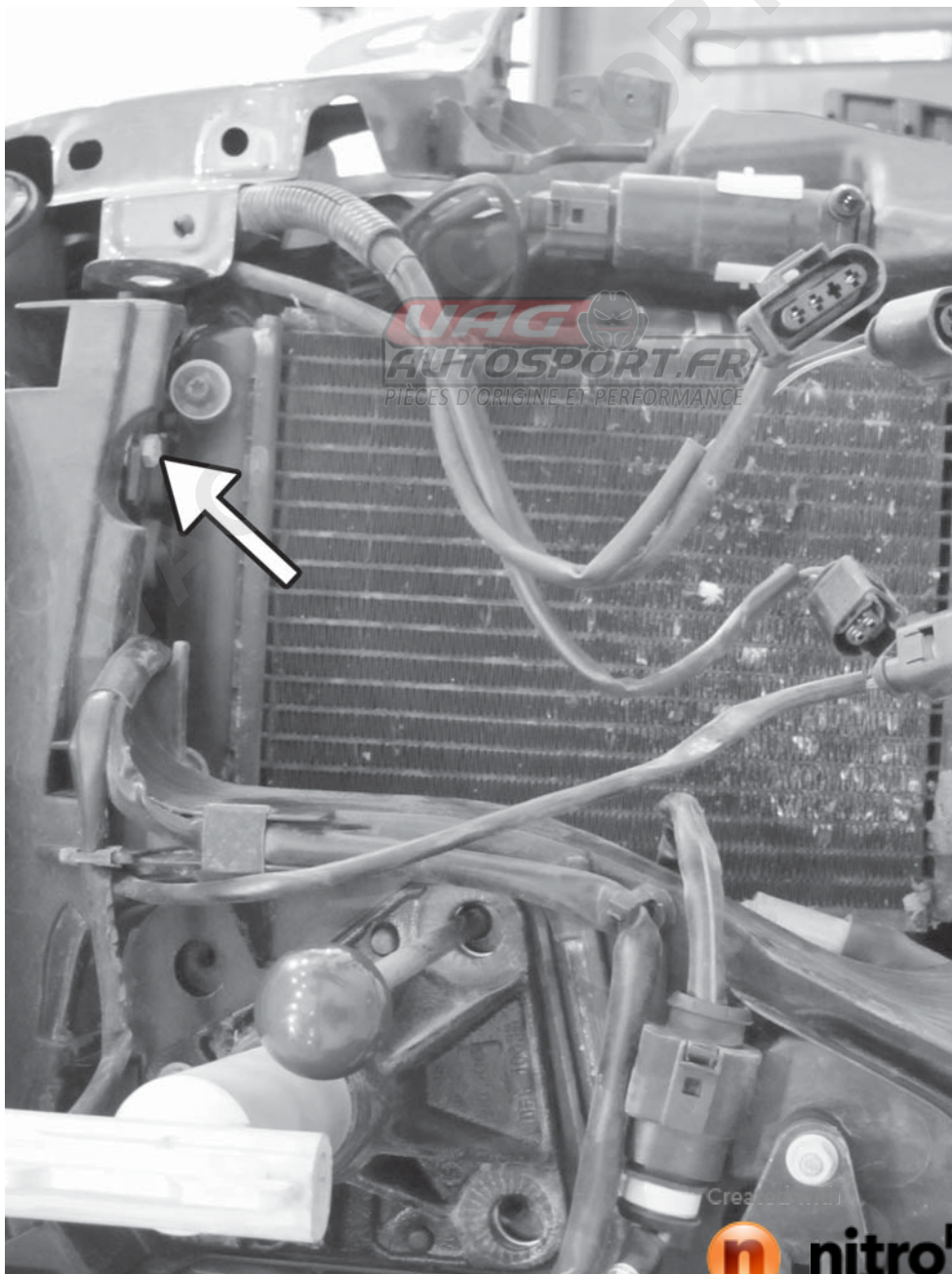

APR, LLC
Alabama 36801
4800 US HWY 280 West Opelika

102) Remove the four (two one each side) T20 torx screws connecting the rubber and plastic air guides on either side of the radiator. Carefully slide the guides towards the outside of the car to access the condenser mounting screws.

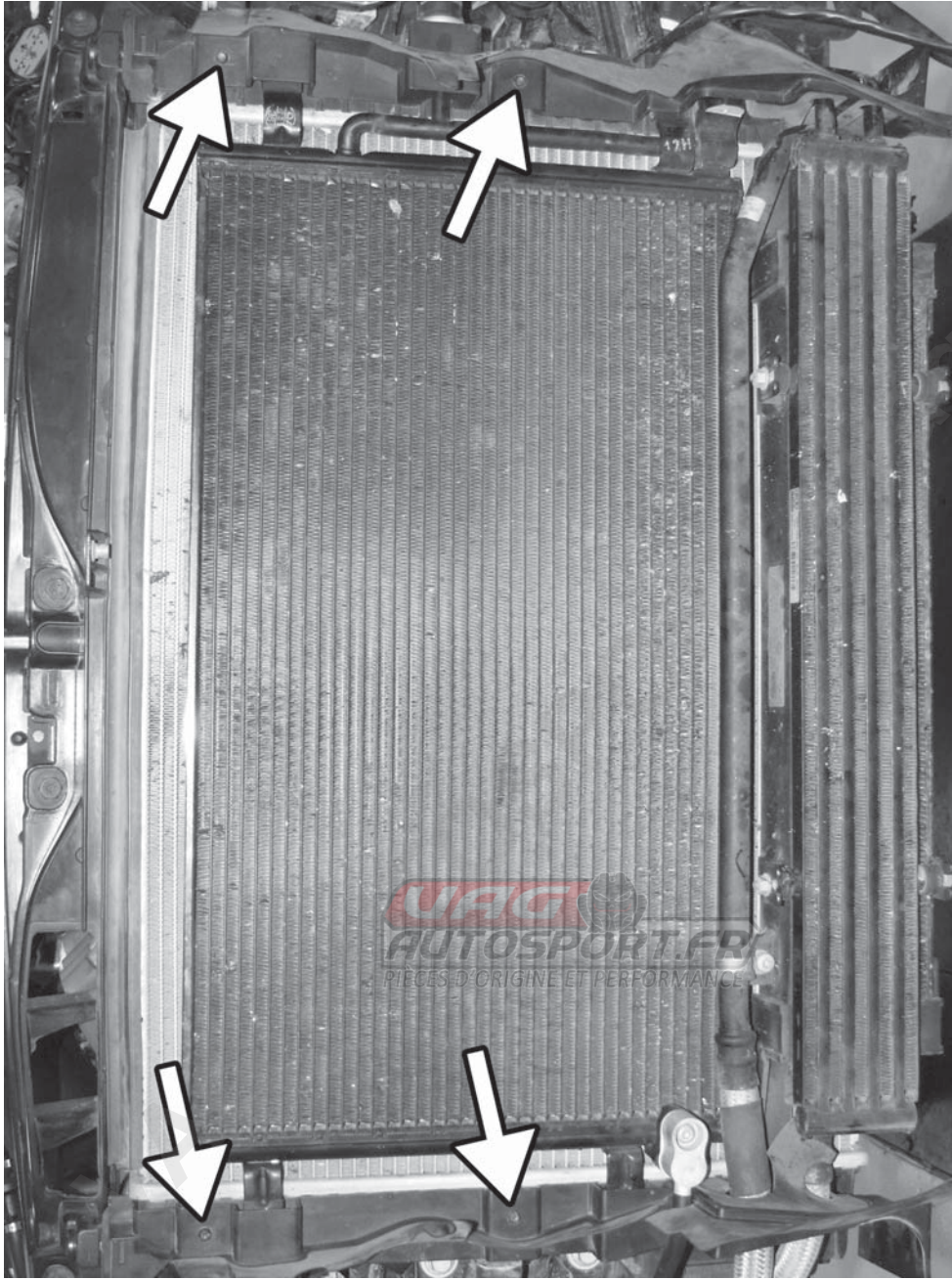

Created with



nitroPDF[®]

professional

download the free trial online at nitropdf.com/professional

APR, LLC
4800 US HWY 280 West Opelika Alabama 36801

103) Remove the four (two on each side) T30 torx screws that hold the condenser to the radiator. The air guides can now be removed from the car.

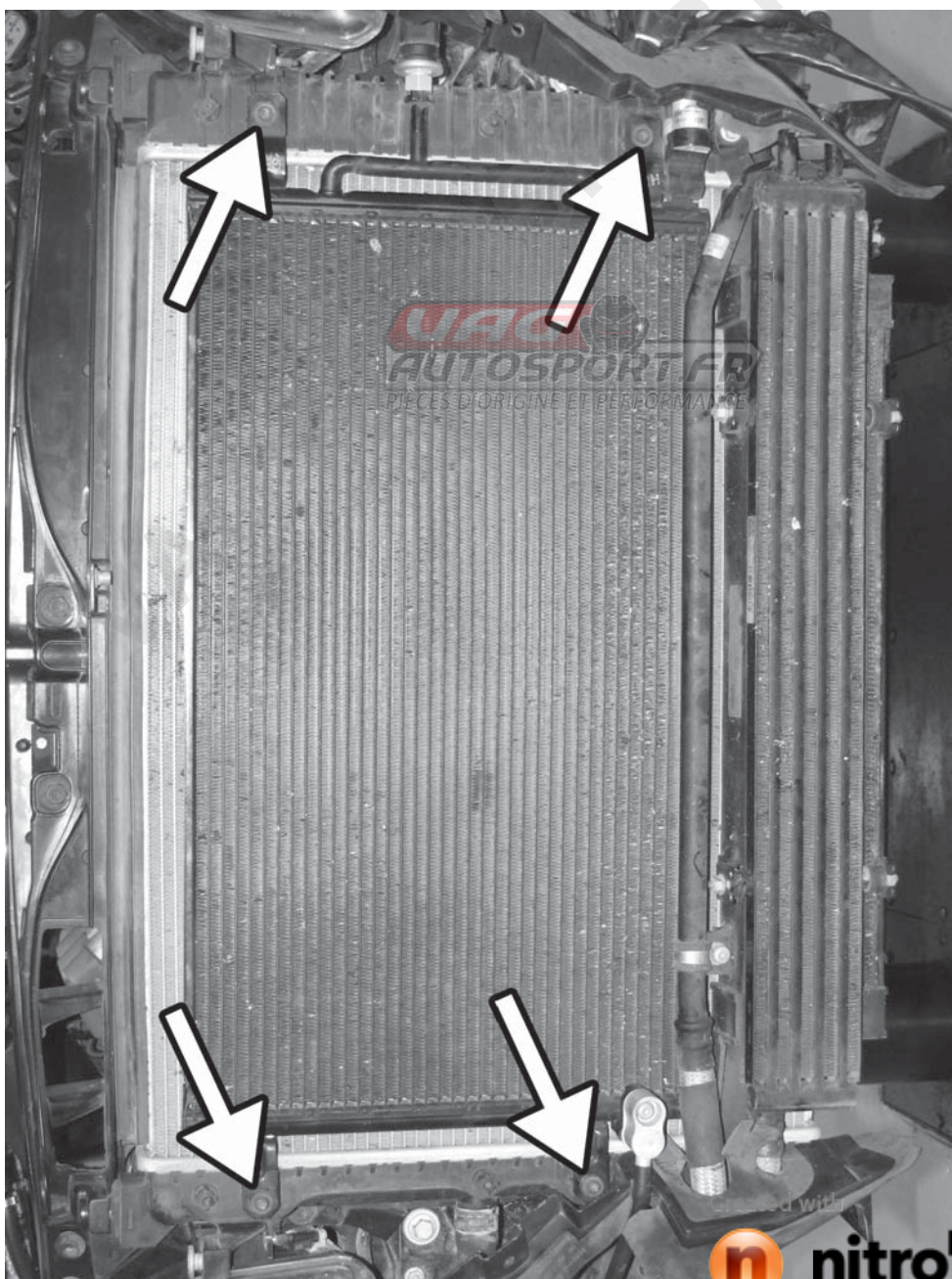

APR, LLC
4 8 0 0 U S H W Y 2 8 0 W e s t O p e l i k a A l a b a m a 3 6 8 0 1

104) Install the supplied mounting brackets on the APR radiator as shown using the 5MM allen screws. Leave the screws loose for adjustment. The APR name on the brackets should be on the front of the brackets and readable.



Created with



nitroPDF[®]

professional

download the free trial online at nitropdf.com/professional

APR, LLC
4800 US HWY 280 West Opelika Alabama 36801

105) Install the APR radiator in front of the condenser by reinstalling the four T30 screws on the radiator. The 5MM allen screws holding the radiator to the APR brackets should still be loose.

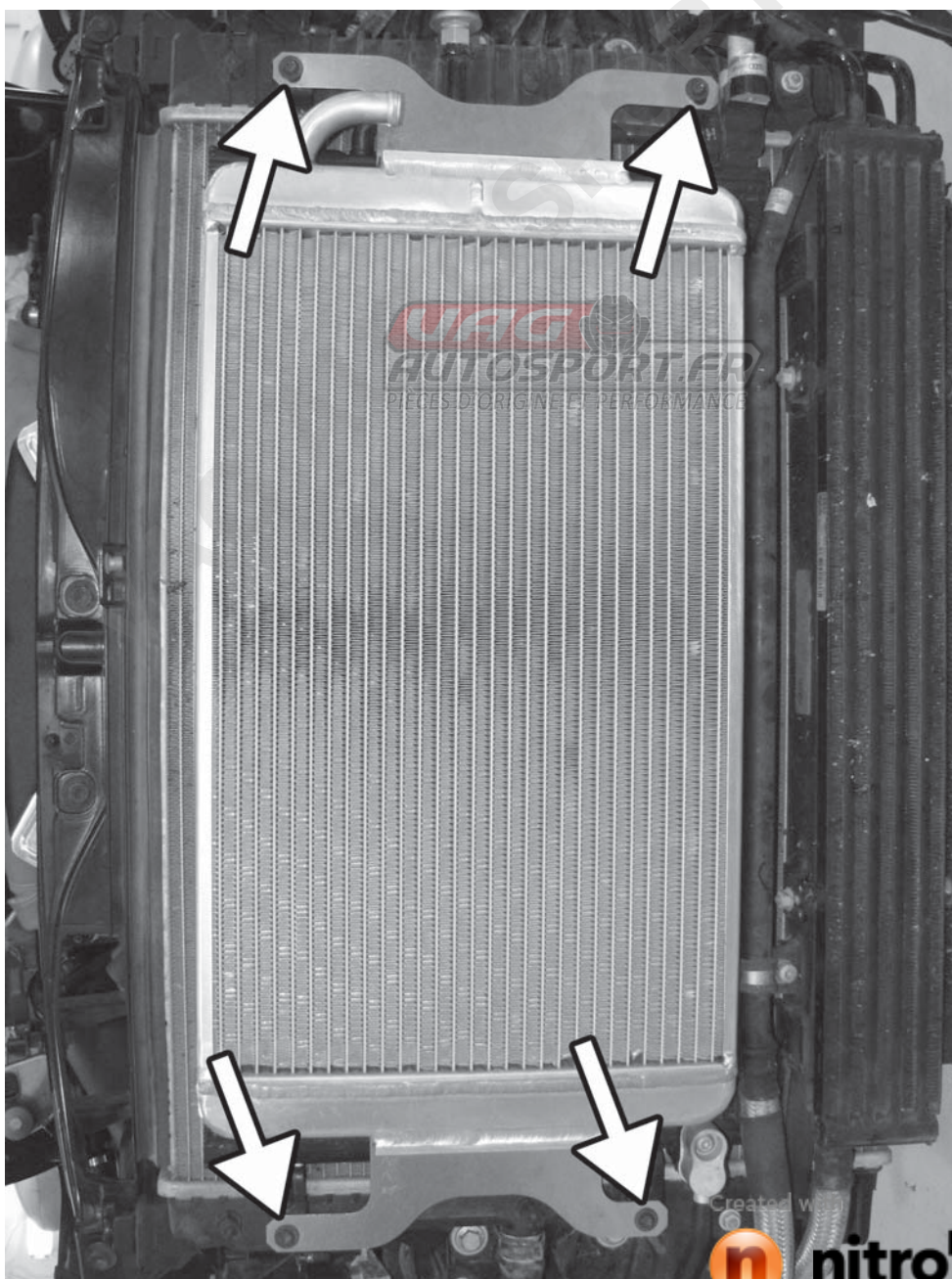

APR, LLC
4800 US HWY 280 West Opelika Alabama 36801



nitro PDF

professional

download the free trial online at nitropdf.com/professional

106) Adjust the gap between the APR and the stock condenser so that they do not touch. Once adjusted, the four 5MM allen screws can be tightened.



Created with

 **nitro** PDF[®] professional

download the free trial online at nitropdf.com/professional

APR, LLC
4800 US HWY 280 West Opelika Alabama 36801

107) Using a chisel and hammer, knock the two plastic tabs that previously held the fan wiring harness off the back of the bumper crash beam.



APR, LLC
Alabama 36801
4800 US HWY 280 West Opelika

108) Disconnect the 10MM bolts from the fan control module bracket on the bumper crash beam. Install the APR coolant pump bracket with the supplied 5MM allen screws and lockwashers between the bumper beam and the factory fan control module bracket as shown. The thread bosses on the bottom of the APR bracket should face towards the APR radiator.

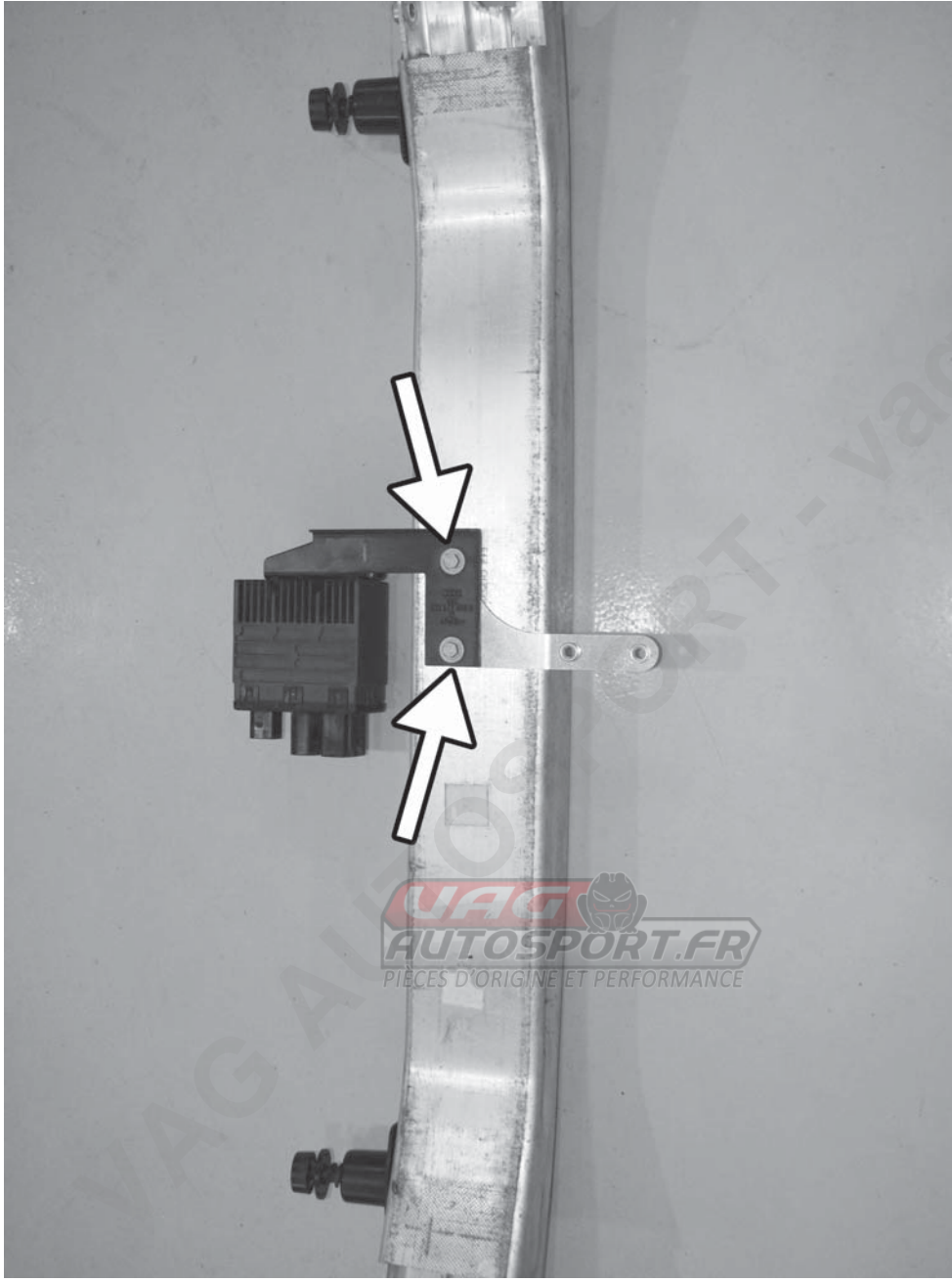

Created with



nitroPDF[®]

professional

download the free trial online at nitropdf.com/professional

APR, LLC
4800 US HWY 280 West Opelika Alabama 36801

109) Reinstall the bumper crash beam with the two stock 10MM triple square screws. Reconnect the electrical connectors to the fan control module.

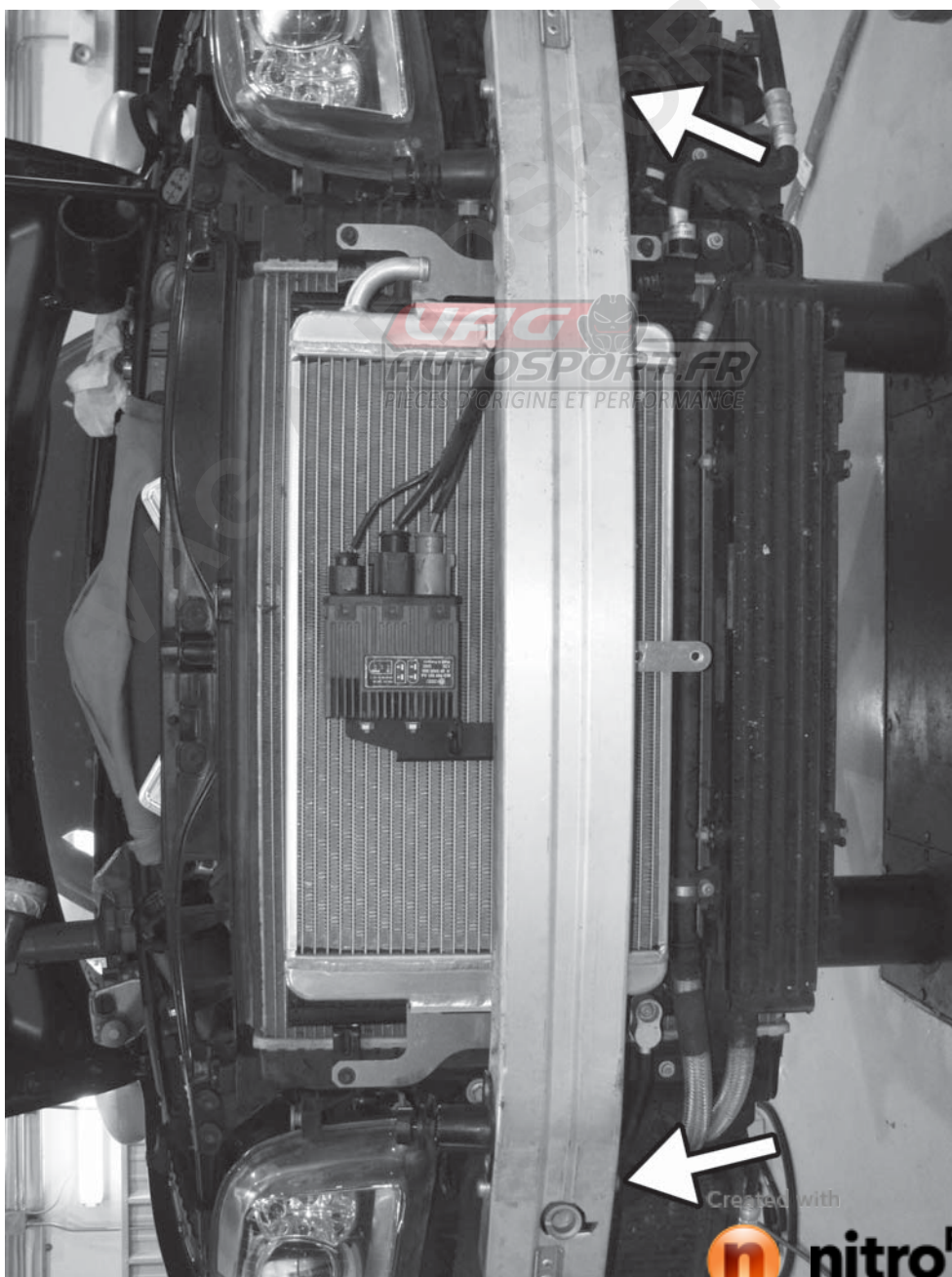

APR, LLC
Alabama 36801
4800 US HWY 280 West Opelika

110) Loosely install the supplied bracket on the APR pump and loosely mount the pump to the previously installed bracket on the bumper beam. Prefit the included "J" coolant hose to confirm fitment. Remove the pump and tighten the phillips screw and nut on the pump bracket.

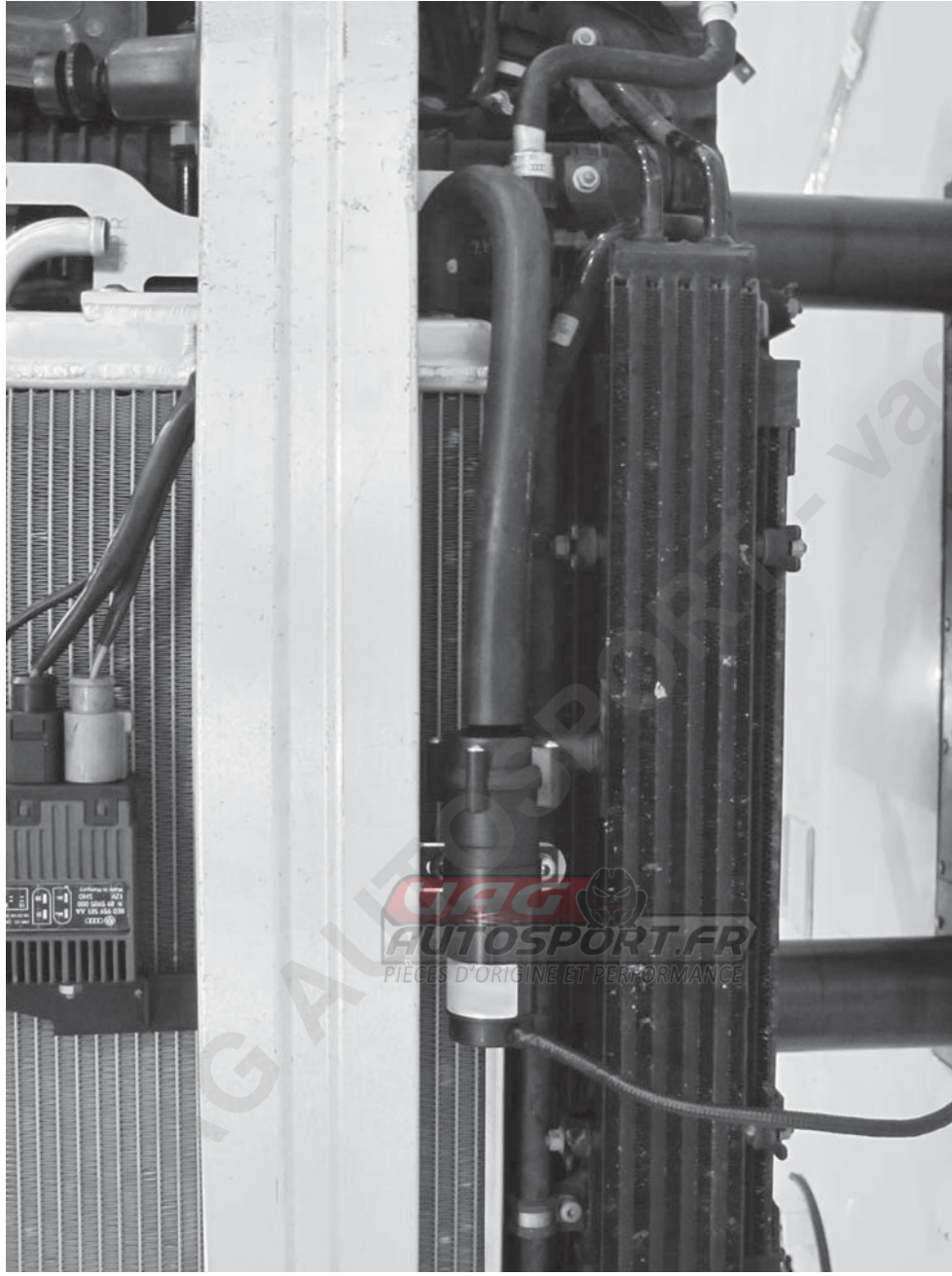

Created with



nitro PDF[®]

professional

download the free trial online at nitropdf.com/professional

APR, LLC
4800 US HWY 280 West Opelika Alabama 36801

111) Install and tighten the 5MM allen screws and lockwashers holding the pump to the bracket on the crash beam. Also install the supplied spring clamps holding the "J" coolant hose in place.

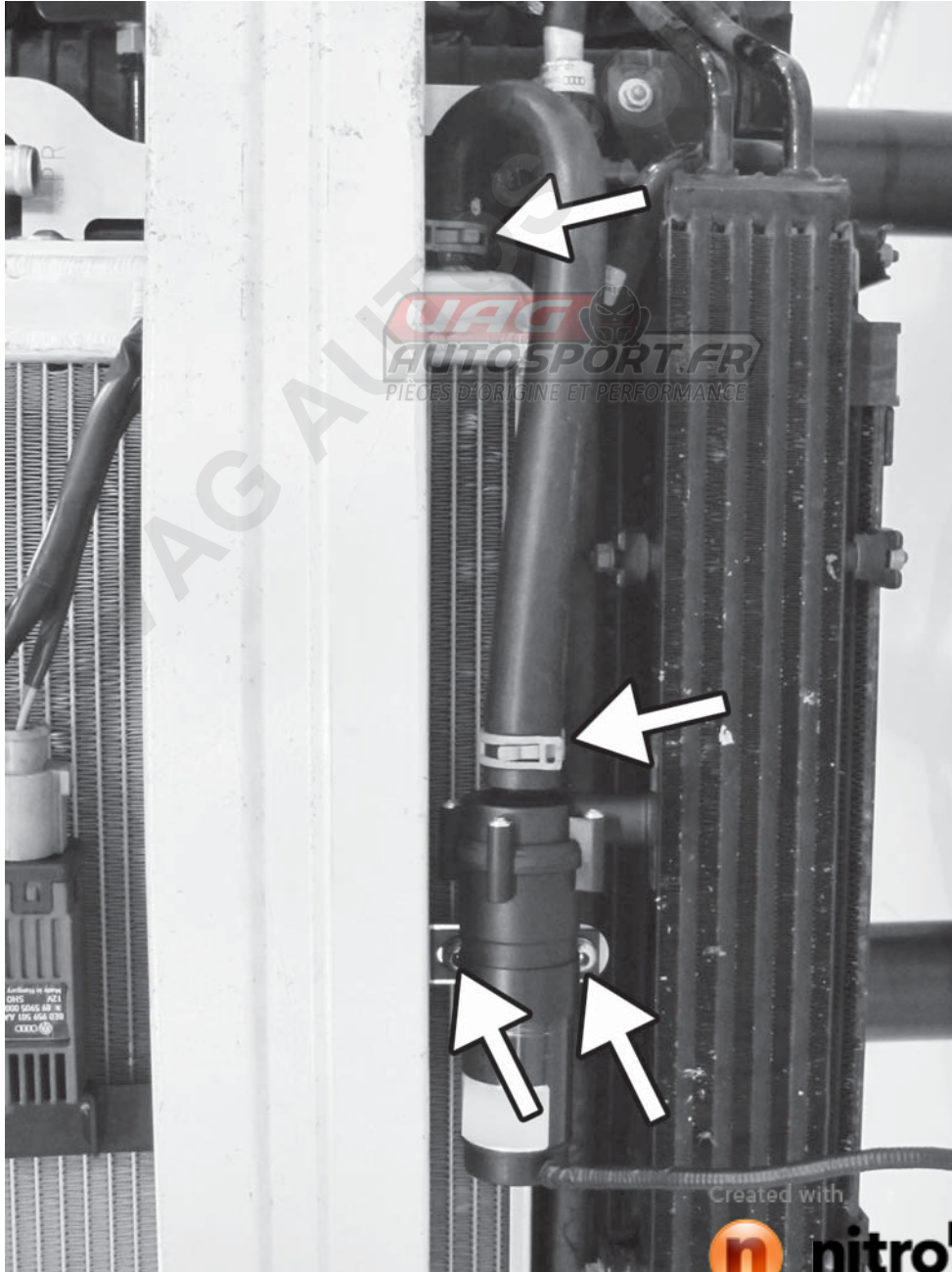

APR, LLC
Alabama 36801
4800 US HWY 280 West Opelika



nitroPDF[®] professional

download the free trial online at nitropdf.com/professional

112) Reinstall the two side radiator air ducts on each side radiator with the stock T30 torx screws.

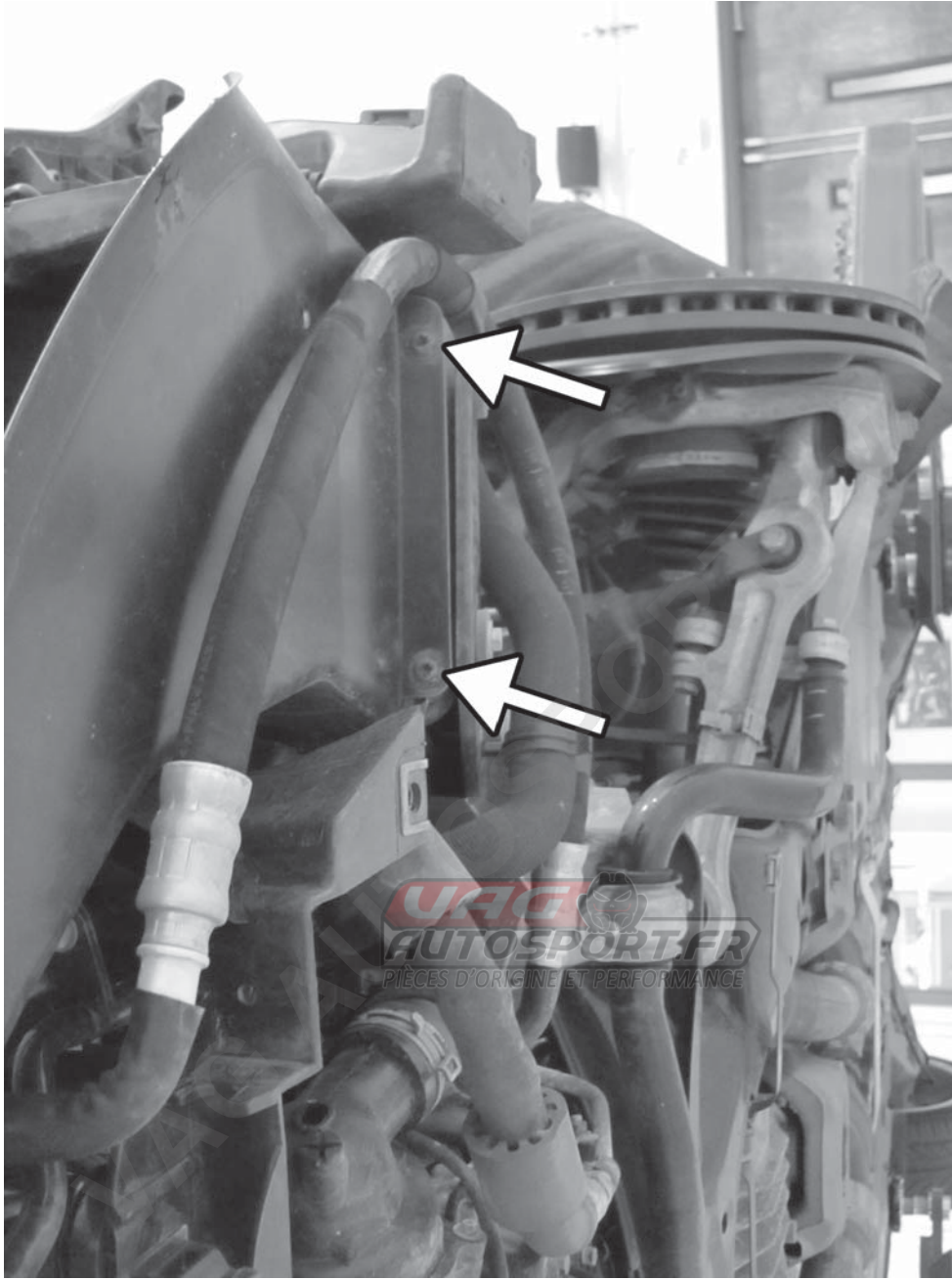

Created with

 **nitro** PDF[®] professional

download the free trial online at nitropdf.com/professional

APR, LLC
4800 US HWY 280 West Opelika Alabama 36801

112) Locate the electrical connection for the factory radiator fans near the factory vacuum pump. Pull the connection up from its mounting bracket, and then disconnect the connector. Installed the supplied APR harness inline on both ends of the existing connectors.

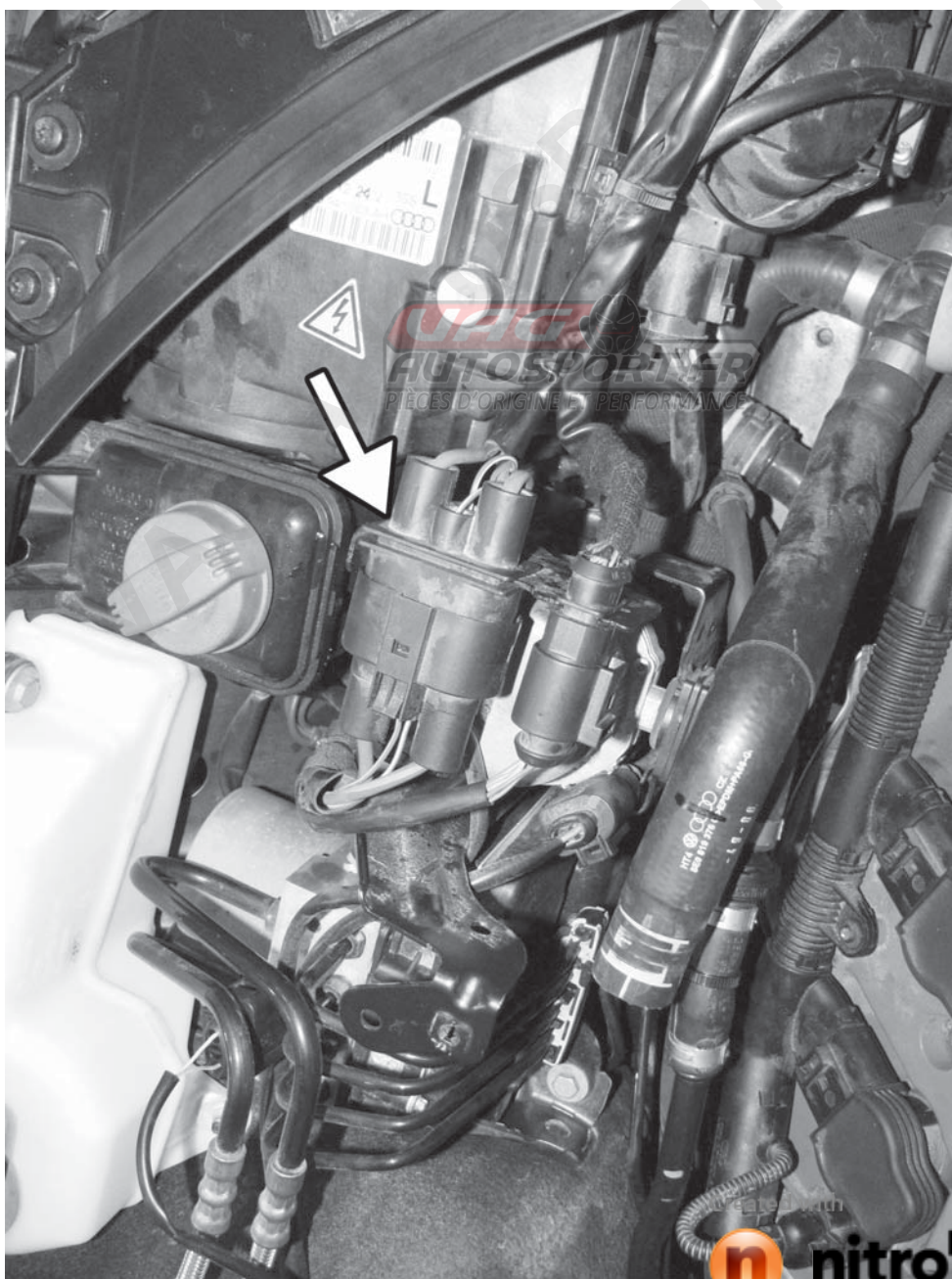

APR, LLC
Alabama 36801
4800 US HWY 280 West Opelika

113) Install the APR connector in the retaining bracket and route the other connector down in front of the vacuum pump bracket. Install the relay with the supplied 5MM allen nut and bolt on the back side of the vacuum pump bracket as shown.

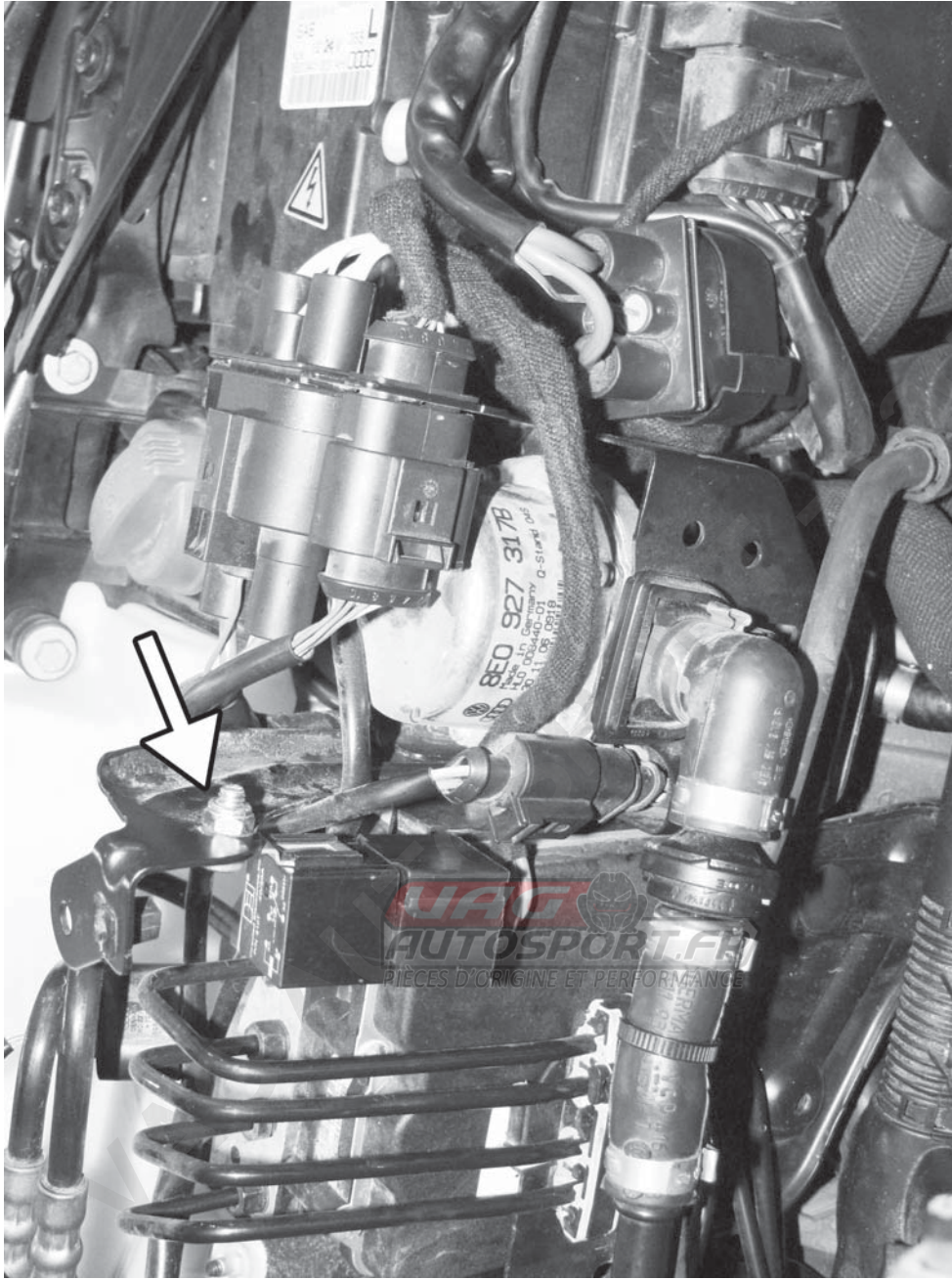

Created with

 **nitro** PDF[®] professional

download the free trial online at nitropdf.com/professional

APR, LLC
4800 US HWY 280 West Opelika Alabama 36801

114) Route the final end of the APR harness to the front of the car, just in between the core support and the left side radiator, and connect to the APR coolant pump wiring harness. Secure the wires with a cable tie.

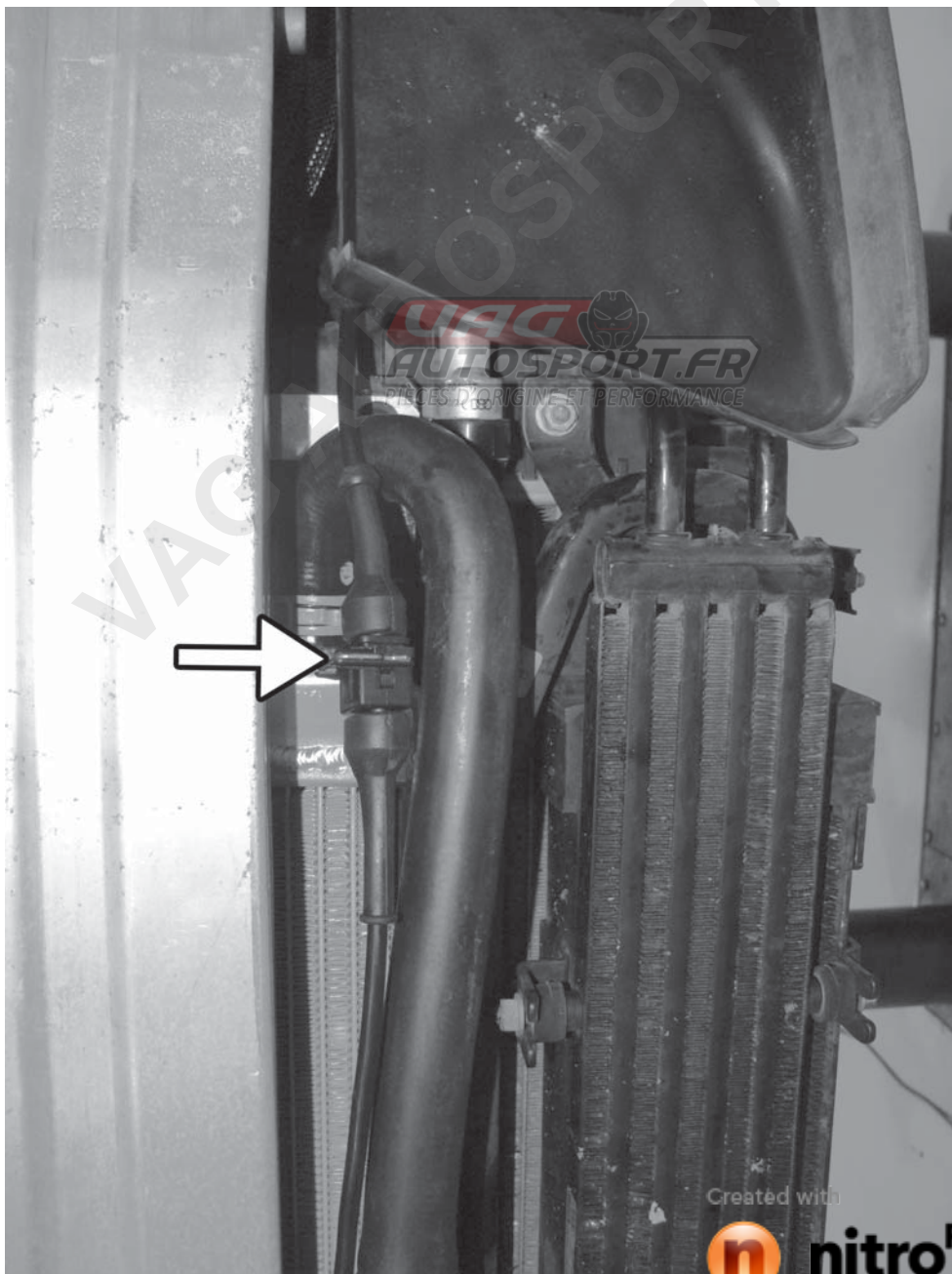

APR, LLC
4800 US HWY 280 West Opelika Alabama 36801

115) Remove the protective cover on the back of the MAF sensor connector. Cut the purple with green wire from the #1 terminal of the connector. Reinstall the protective cover on the MAF sensor connector.

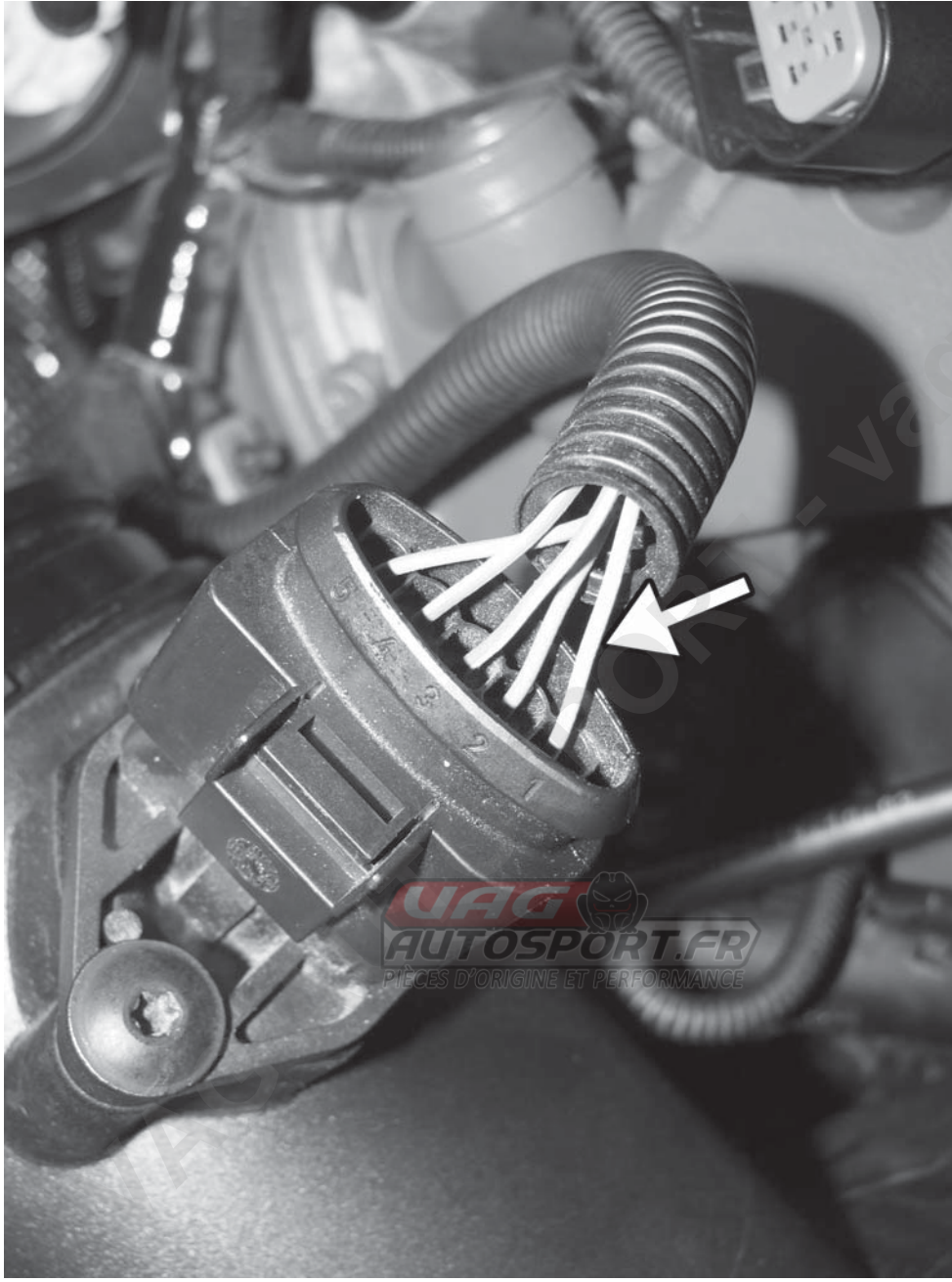

Created with



nitro PDF[®]

professional

download the free trial online at nitropdf.com/professional

APR, LLC
4800 US HWY 280 West Opelika Alabama 36801

116) Follow the wiring harness from the MAF sensor back to the joint where it splits from the main harness. CAREFULLY cut and remove the outer sheath at the joint to expose the wires. Locate the previously cut purple with green wire that runs to the MAF sensor, and pull the wire back through the joint.

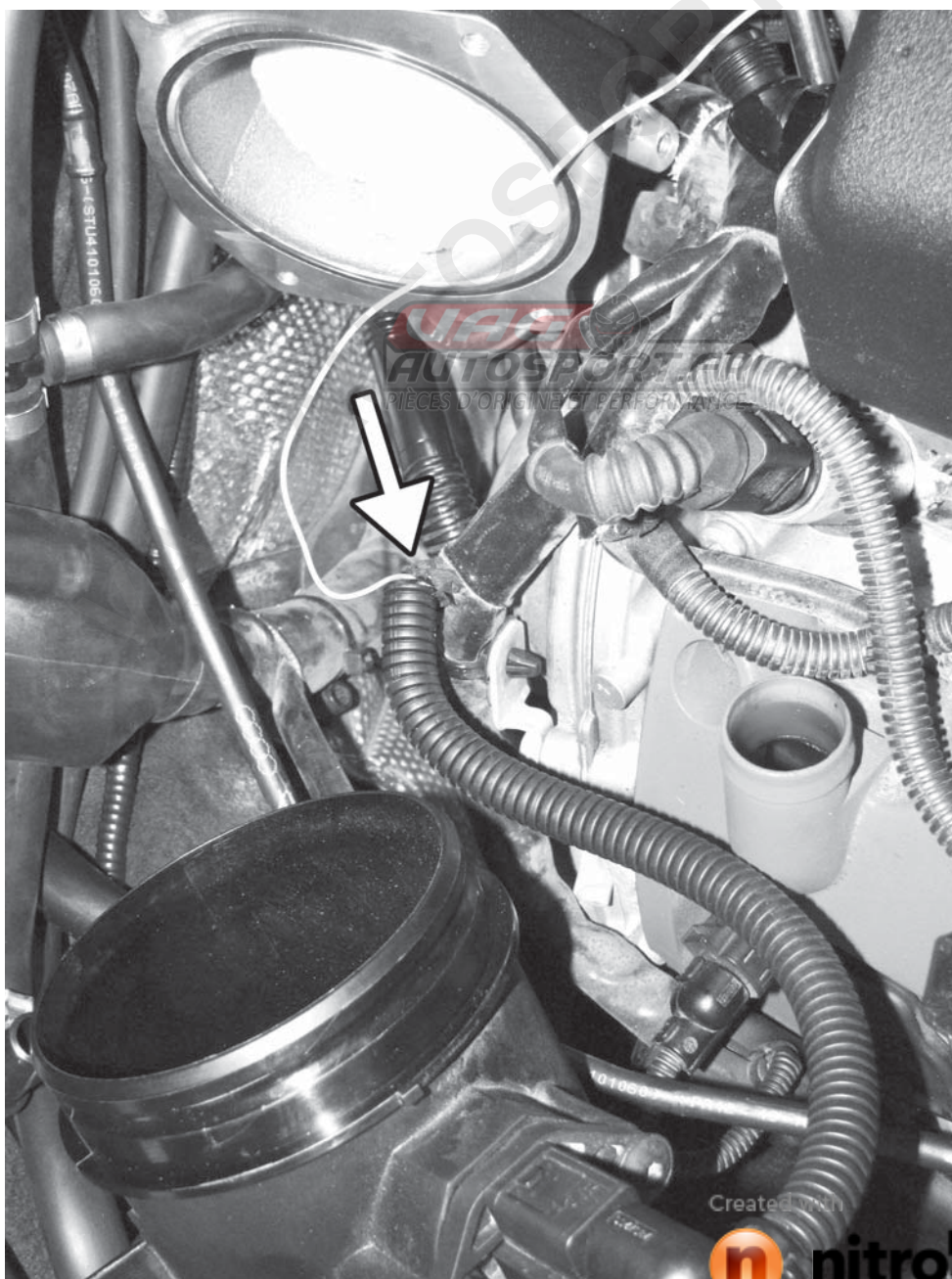

APR, LLC
Alabama 36801
4800 US HWY 280 West Opelika

117) Route the supplied IAT harness behind the supercharger. Cut the purple with green wire and connect the crimp connection to the APR IAT harness. Once crimped, the connection needs to be heated sufficiently to break the internal solder inside of the connection.

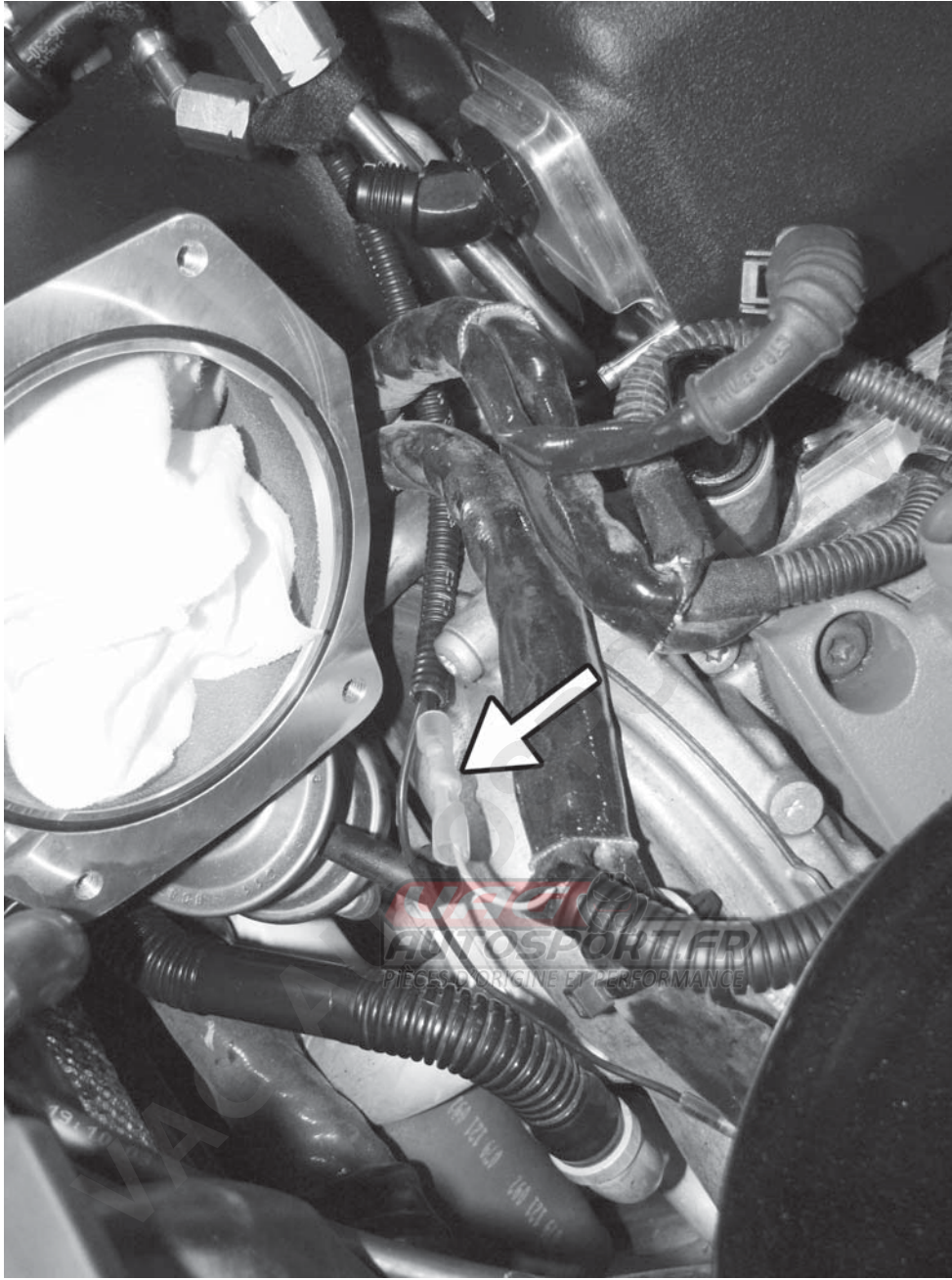

Created with



nitro PDF[®]

professional

download the free trial online at nitropdf.com/professional

APR, LLC
4800 US HWY 280 West Opelika Alabama 36801

118) Loosen the T30 torx ground connection near the right HPFP. Connect the eyelet from the APR IAT harness to the ground connection and retighten. Tape all connections made with cloth electrical tape.

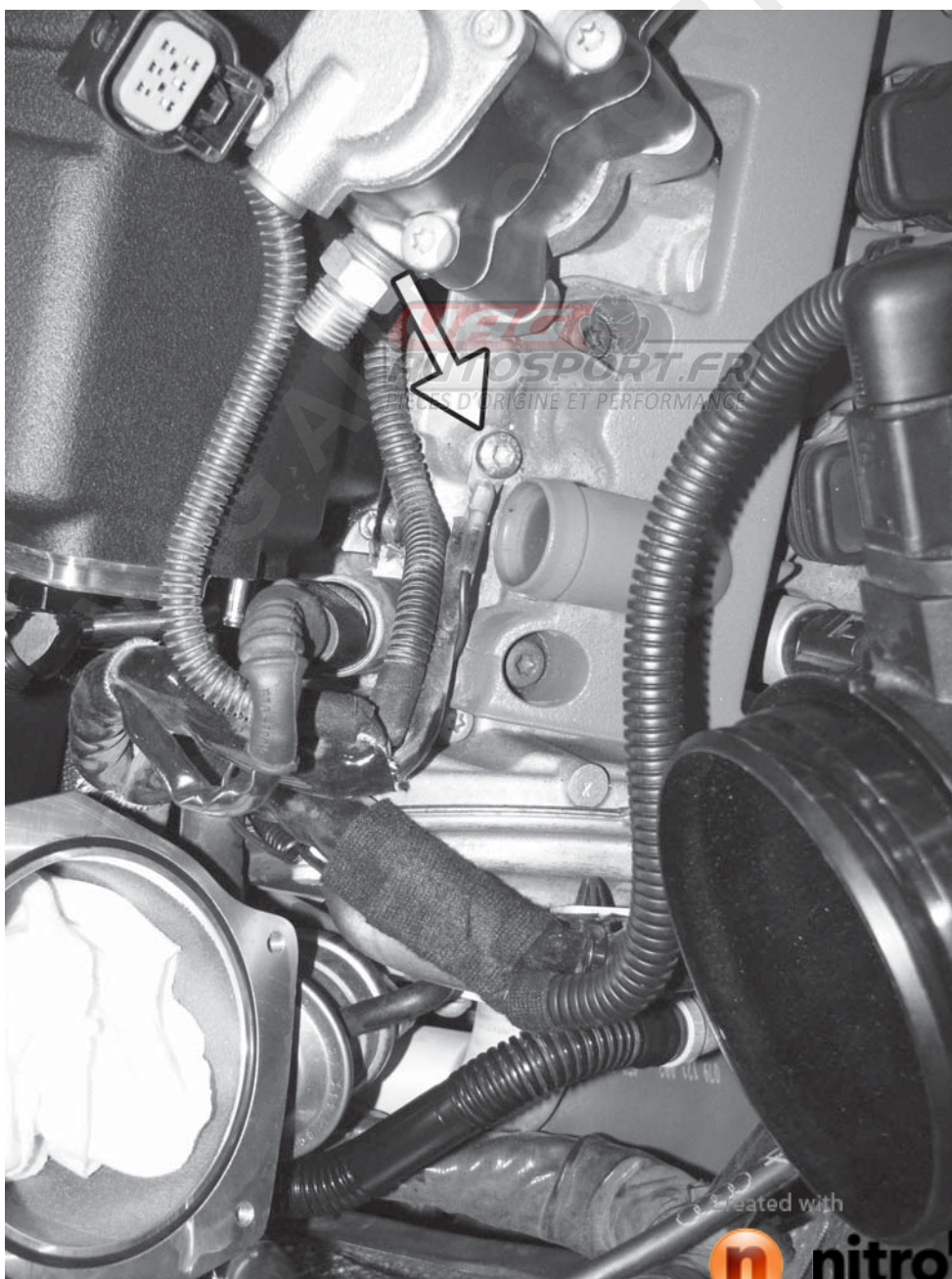

APR, LLC
Alabama 36801
4800 US HWY 280 West Opelika



nitro PDF

professional

download the free trial online at nitropdf.com/professional

119) Connect the throttle body wiring harness to the throttle body. Make sure all debris is clear from the cast inlet elbow and that the mating surface of the throttle body is clean. No gasket is used in this application, as the throttle body is sealed by the O-ring on the cast inlet elbow.

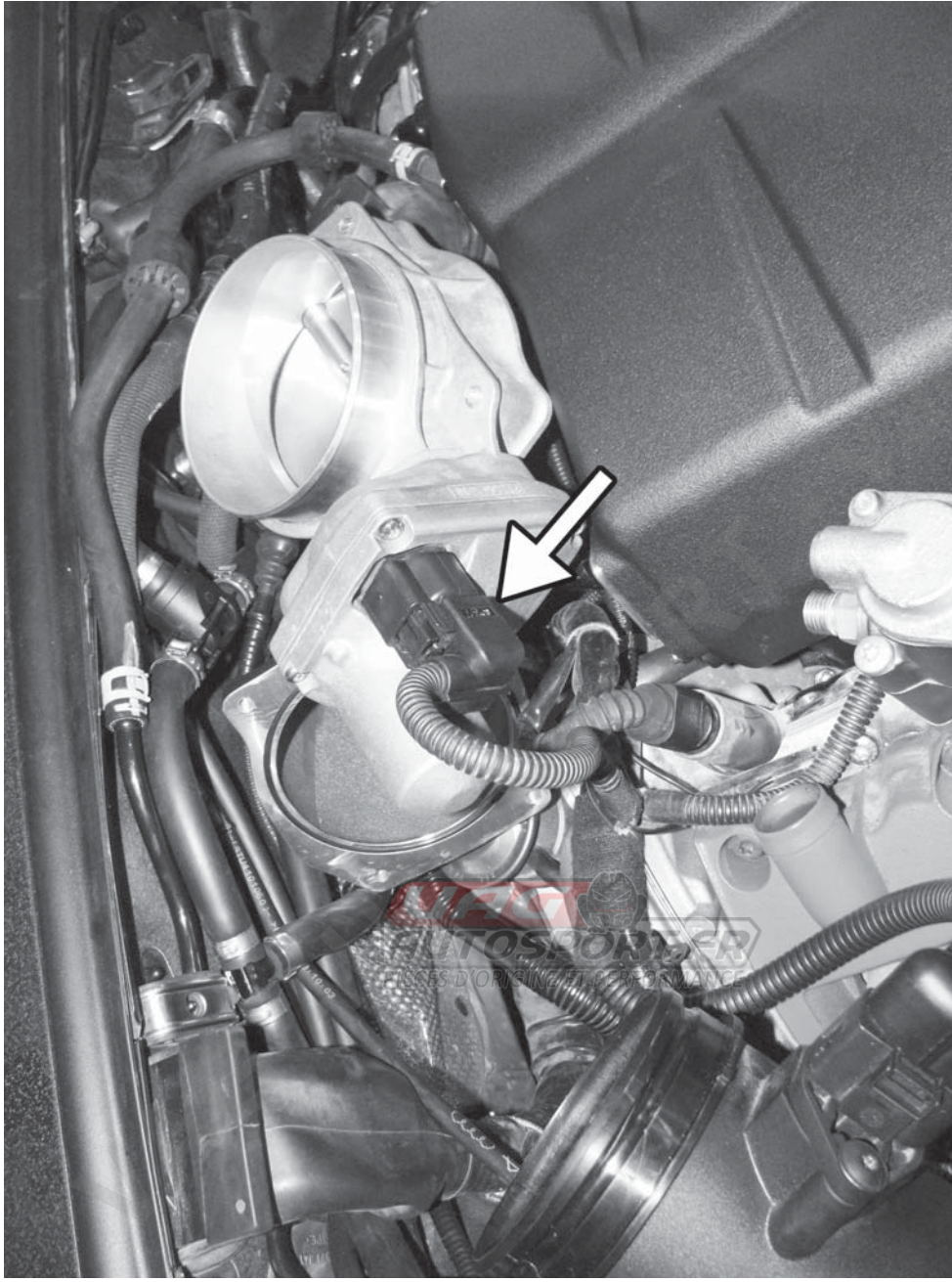

Created with



nitro PDF[®]

professional

download the free trial online at nitropdf.com/professional

APR, LLC
4800 US HWY 280 West Opelika Alabama 36801

120) Gently but forcefully push the throttle body down in place as oriented in the picture. Once down, install the supplied 5MM allen screw in the top right hole with the APR bracket as shown, but do not tighten the connection.

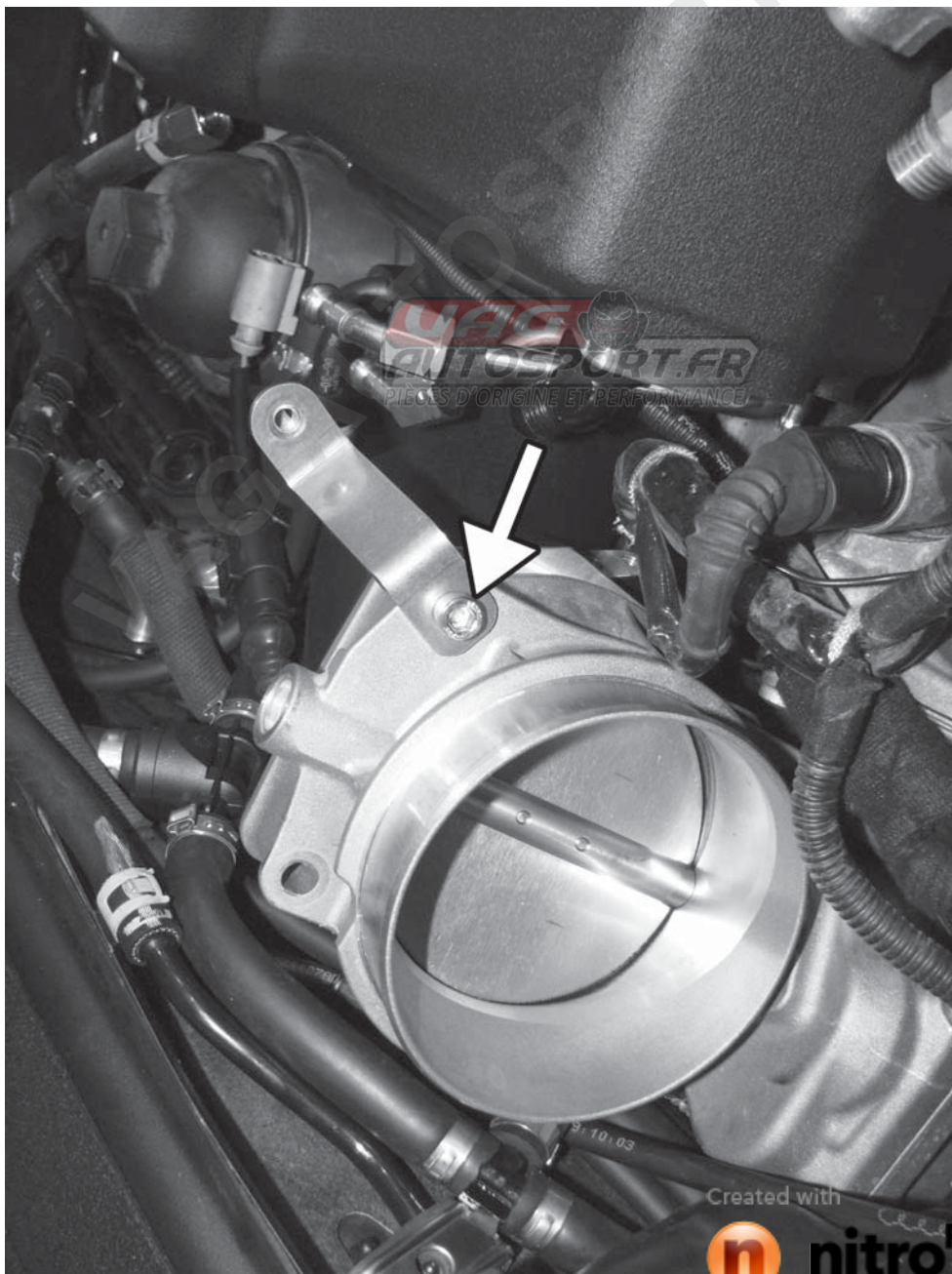

APR, LLC
4800 US HWY 280 West Opelika Alabama 36801

121) Pressing down again, install the top left bolt in the throttle body. You are pushing the throttle body against the plastic accordion hose of the secondary air system. The screw holding the bracket to this accordion hose should have been removed in a previous step. Thread both upper throttle body screws enough to almost seat the throttle body against the cast inlet elbow.

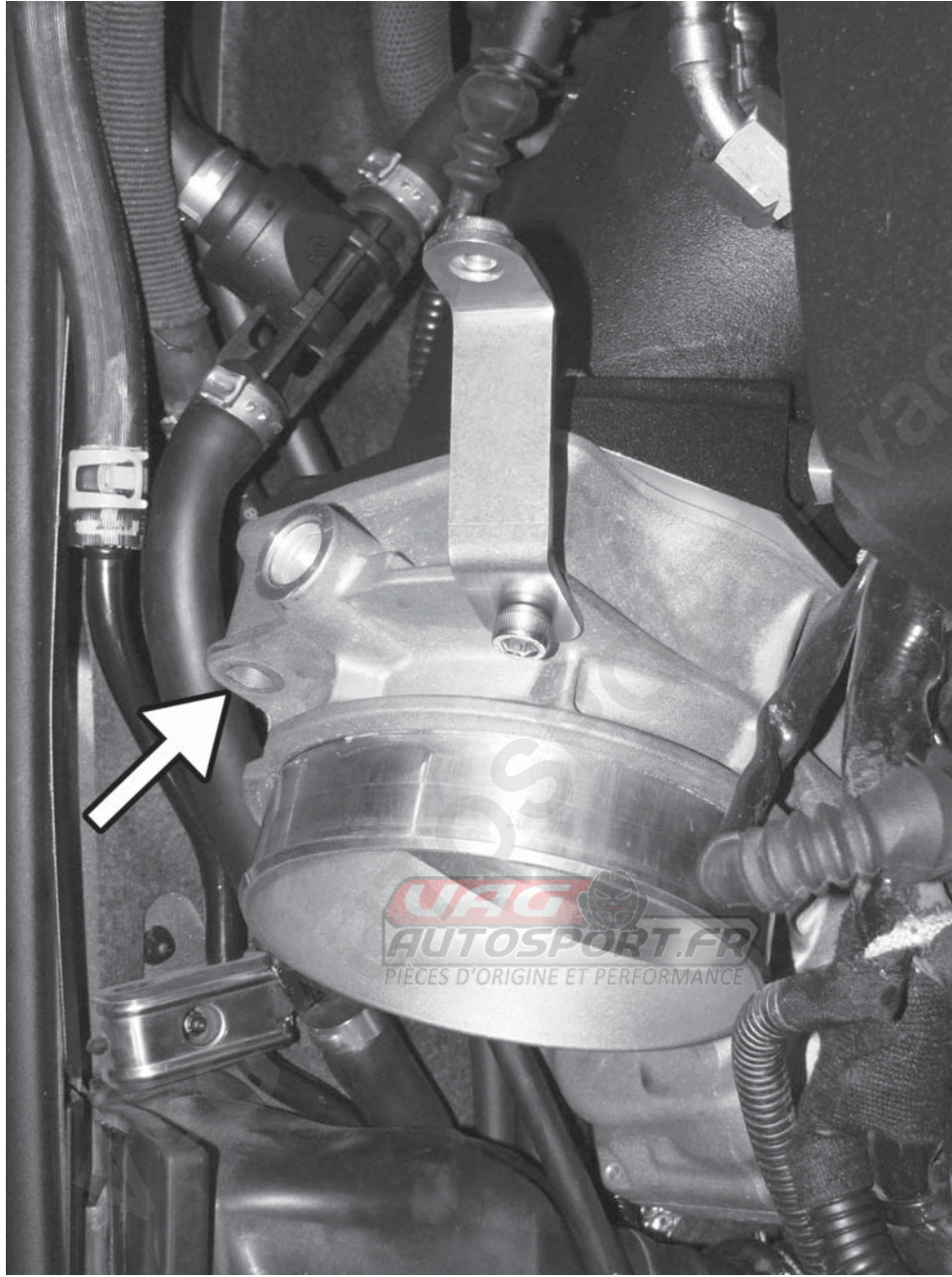

Created with



nitroPDF[®]

professional

download the free trial online at nitropdf.com/professional

APR, LLC
4800 US HWY 280 West Opelika Alabama 36801

122) Remove the airbox lid. First disconnect the secondary air pipe from the front of the box, unclip the hose from the side of the box, unplug the MAF sensor, and unclip the N80 hose. Finally remove the two Phillips screws and lift the airbox cover up and out of the car.

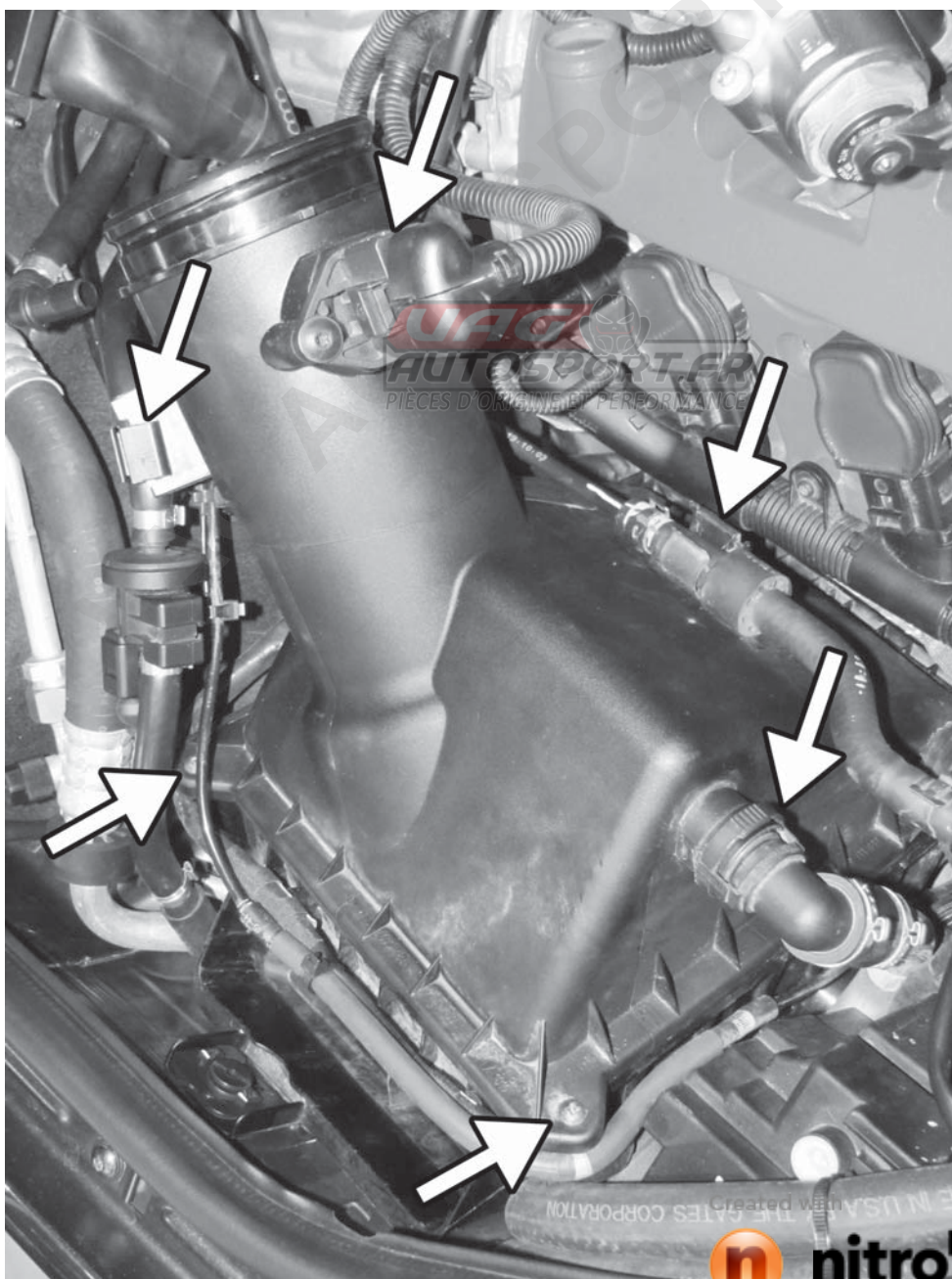

APR, LLC
Alabama 36801
4800 US HWY 280 West Opelika

123) Install the bottom two 5MM allen screws into the throttle body. In a criss-cross pattern, tighten all four throttle body screws to 85 lb-in.

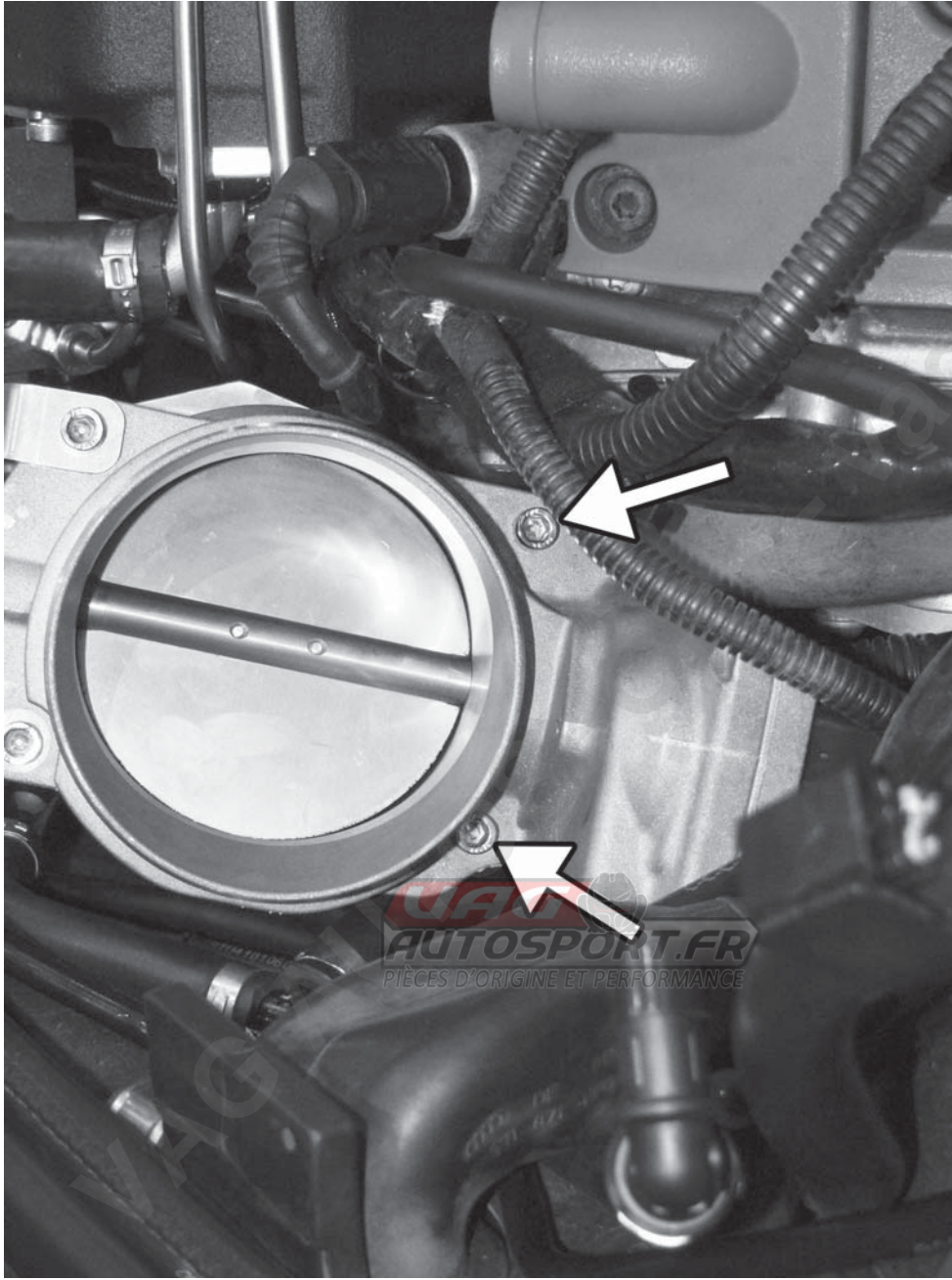

Created with

 **nitro** PDF[®] professional

download the free trial online at nitropdf.com/professional

APR, LLC
4800 US HWY 280 West Opelika Alabama 36801

124) Reinstall the airbox lid with the APR silicone throttle body hose and hose clamps. Loosely place the hose over the MAF housing and the throttle body as shown. As you push down on the hose and the airbox lid, the two will seat in place. Reconnect and secure all connections on the airbox lid that were removed and tighten the hose clamps on the APR silicone hose.

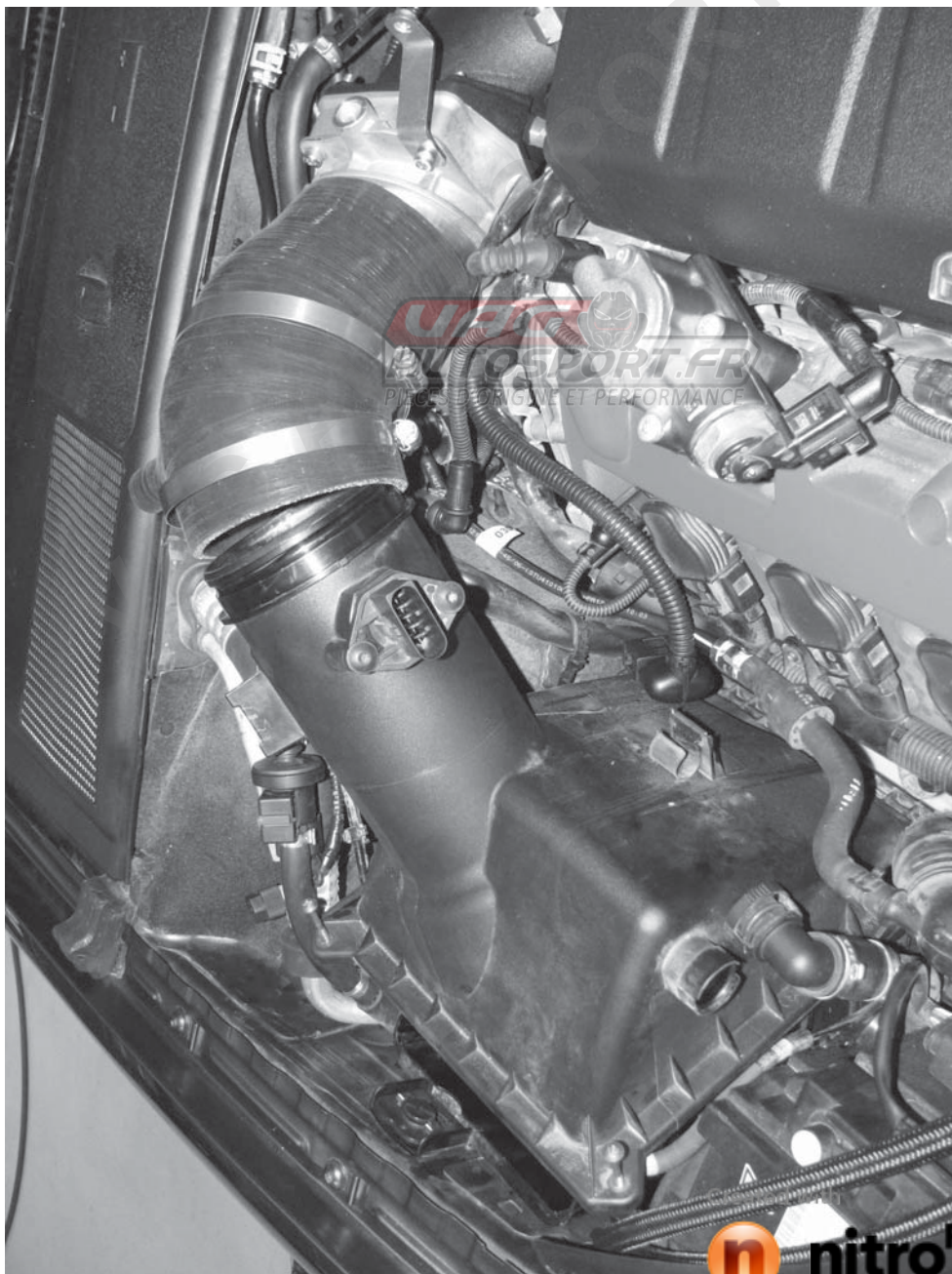

APR, LLC
4800 US HWY 280 West Opelika Alabama 36801

125) Install the 90° fitting from the vacuum hose assembly into the APR silicone throttle body hose.

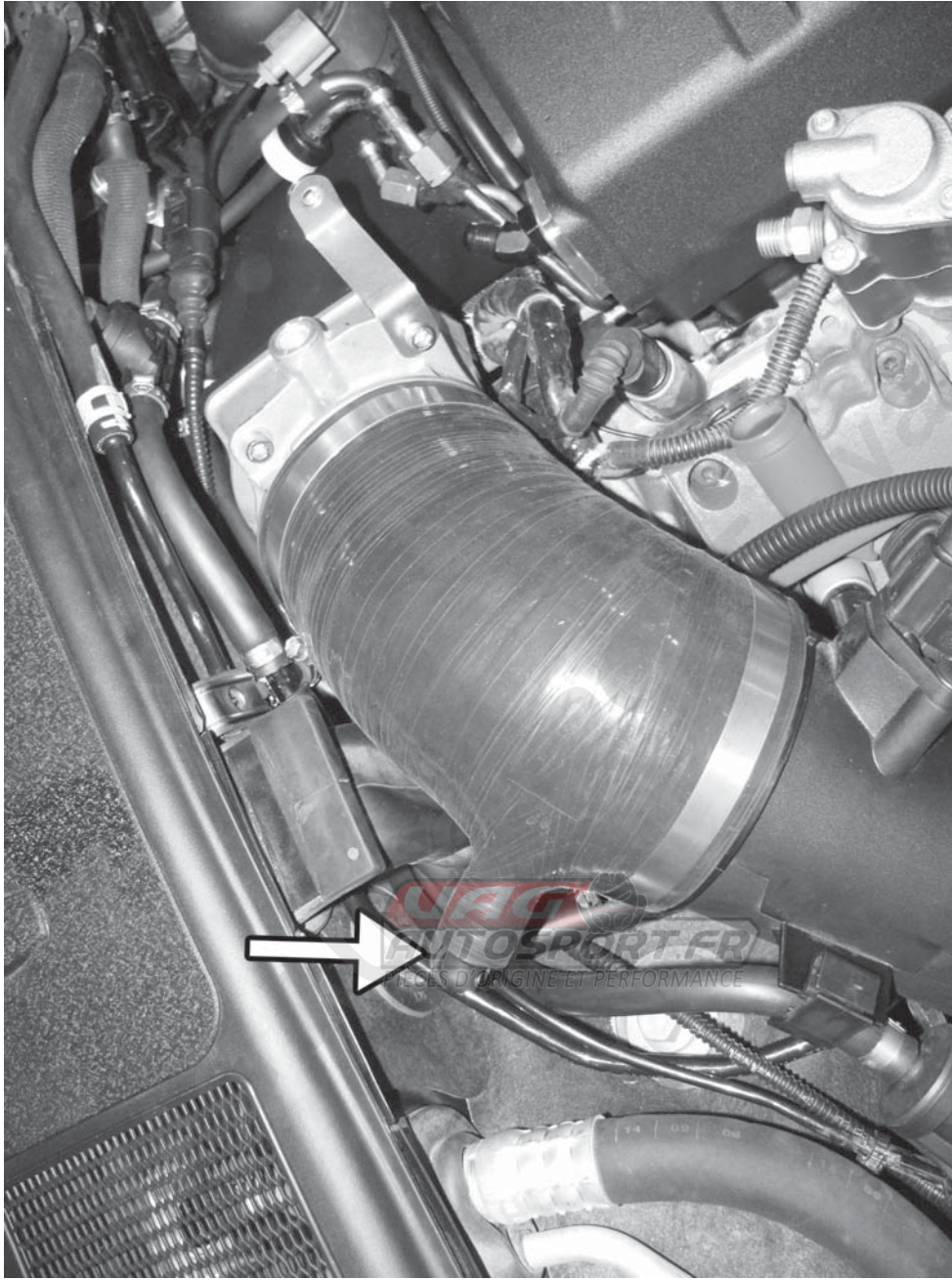

Created with

 **nitro** PDF[®] professional

download the free trial online at nitropdf.com/professional

APR, LLC
4800 US HWY 280 West Opelika Alabama 36801

126) Install the supplied 90° hose and Y adaptor on the outlet of the coolant pump with the supplied hose clamps.

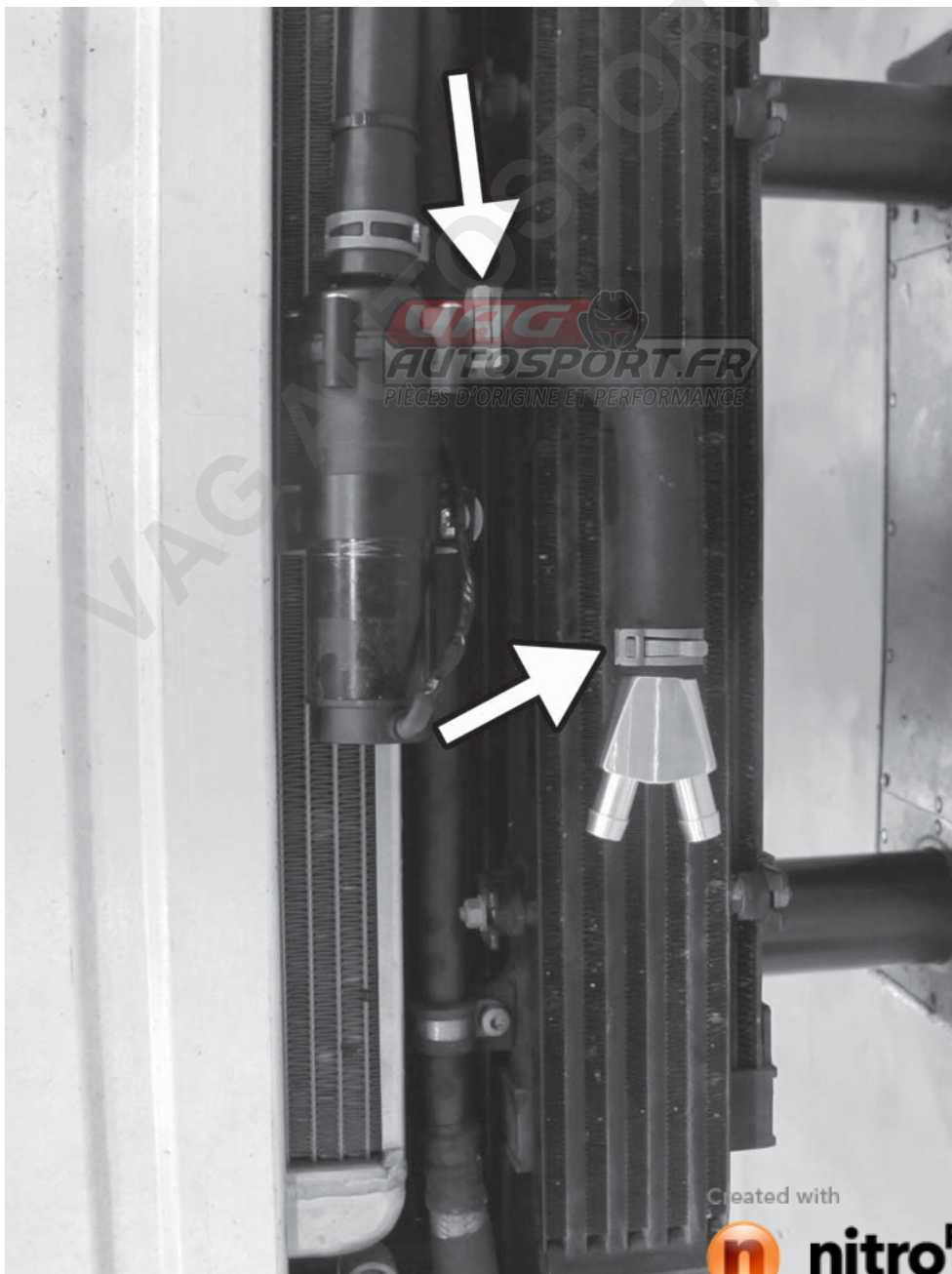

APR, LLC
Alabama 36801
4800 US HWY 280 West Opelika

127) Install the two longer 1/2" coolant lines as shown. Route the lines behind the right headlight, the air conditioner pipe, and the bumper beam. Connect the hoses to the Y adaptor with the supplied hose clamps.



Created with



nitro PDF[®]

professional

download the free trial online at nitropdf.com/professional

APR, LLC
4800 US HWY 280 West Opelika Alabama 36801

128) Connect the right side coolant lines to the front of the supercharger coolers with the supplied hose clamps. Make sure the left side hose runs underneath the right side hose, as shown. Secure the left side hose to the bottom of the right side hose with a cable tie to make sure it does not fall down on the belt.

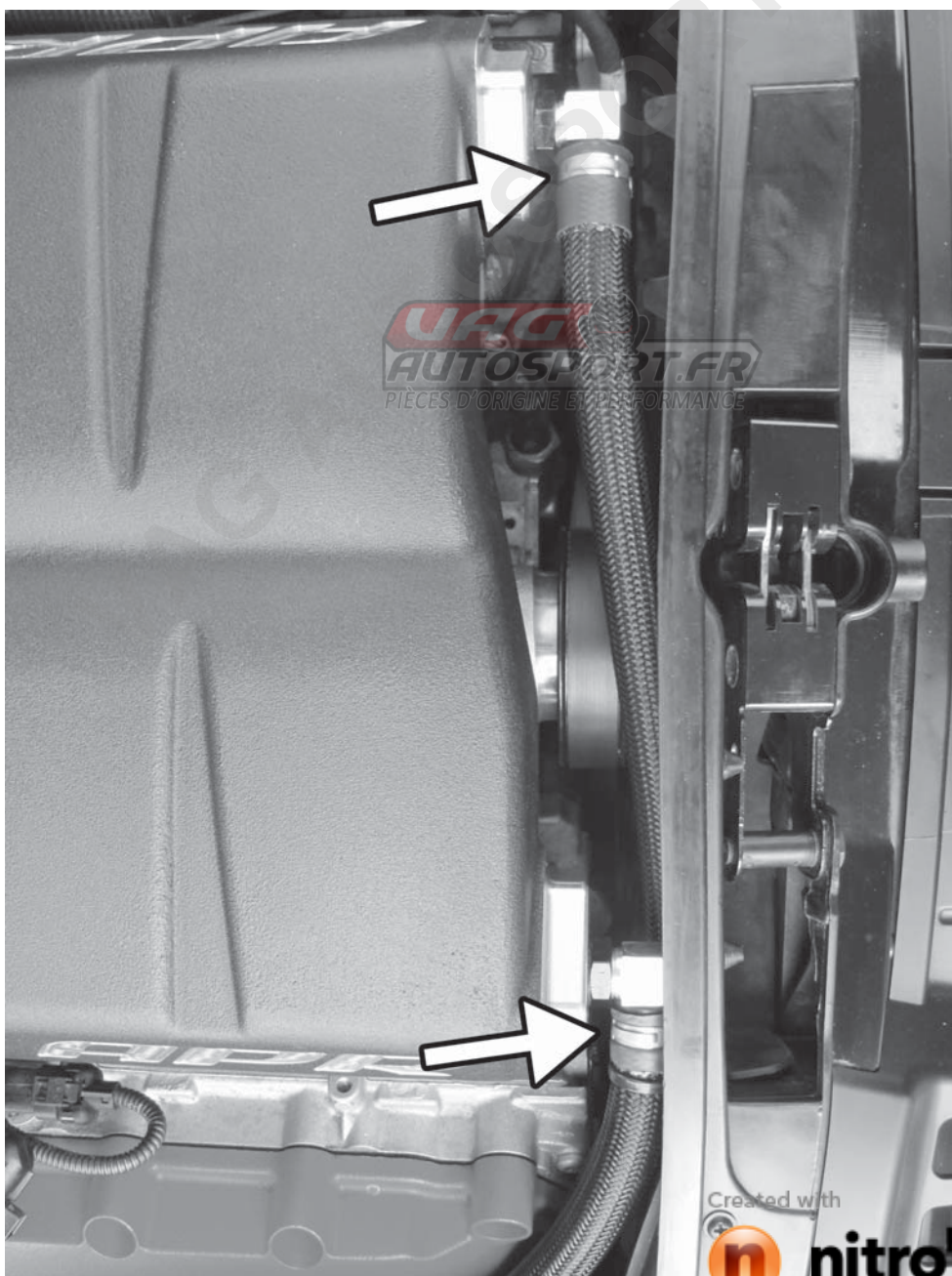

APR, LLC
Alabama 36801
4800 US HWY 280 West Opelika

129) Reinstall the factory air ducting to the airbox. Install the two phillips screws holding the ducting to the radiator core support.

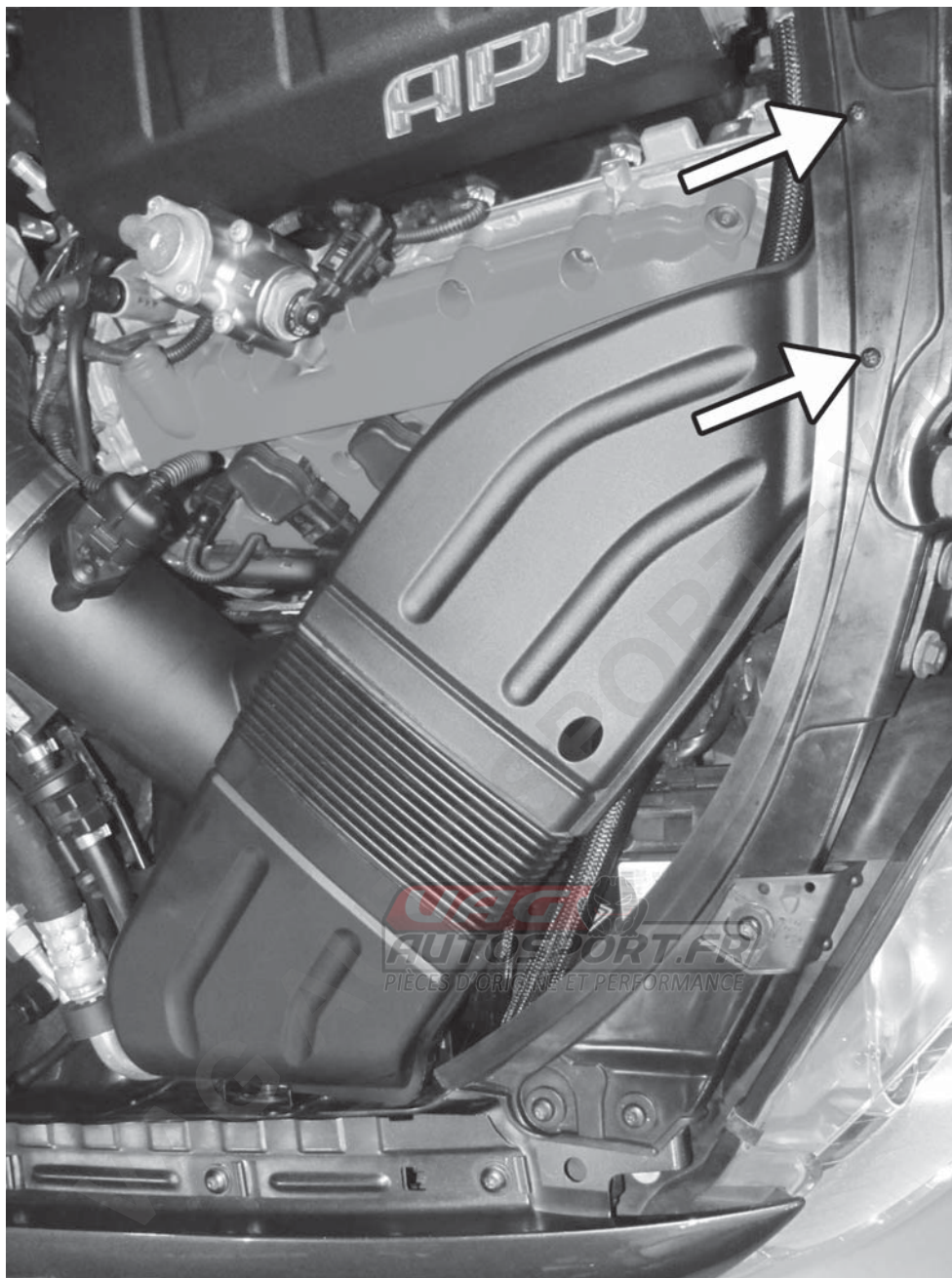

Created with



nitro PDF[®]

professional

download the free trial online at nitropdf.com/professional

APR, LLC
4800 US HWY 280 West Opelika Alabama 36801

130) Reinstall the factory coolant expansion tank, remembering to connect the coolant level sensor and both the inlet and outlet hoses. Connect the biggest port of the APR coolant reservoir to the longest large coolant line, and secure with a supplied clamp. A water-based lubricant may be needed to slip the hose and clamp over the port.



APR, LLC
4800 US HWY 280 West Opelika Alabama 36801

Created with



nitroPDF

professional

download the free trial online at nitropdf.com/professional

131) Route the other end of the APR coolant line underneath the headlight, and in front of the side radiator.

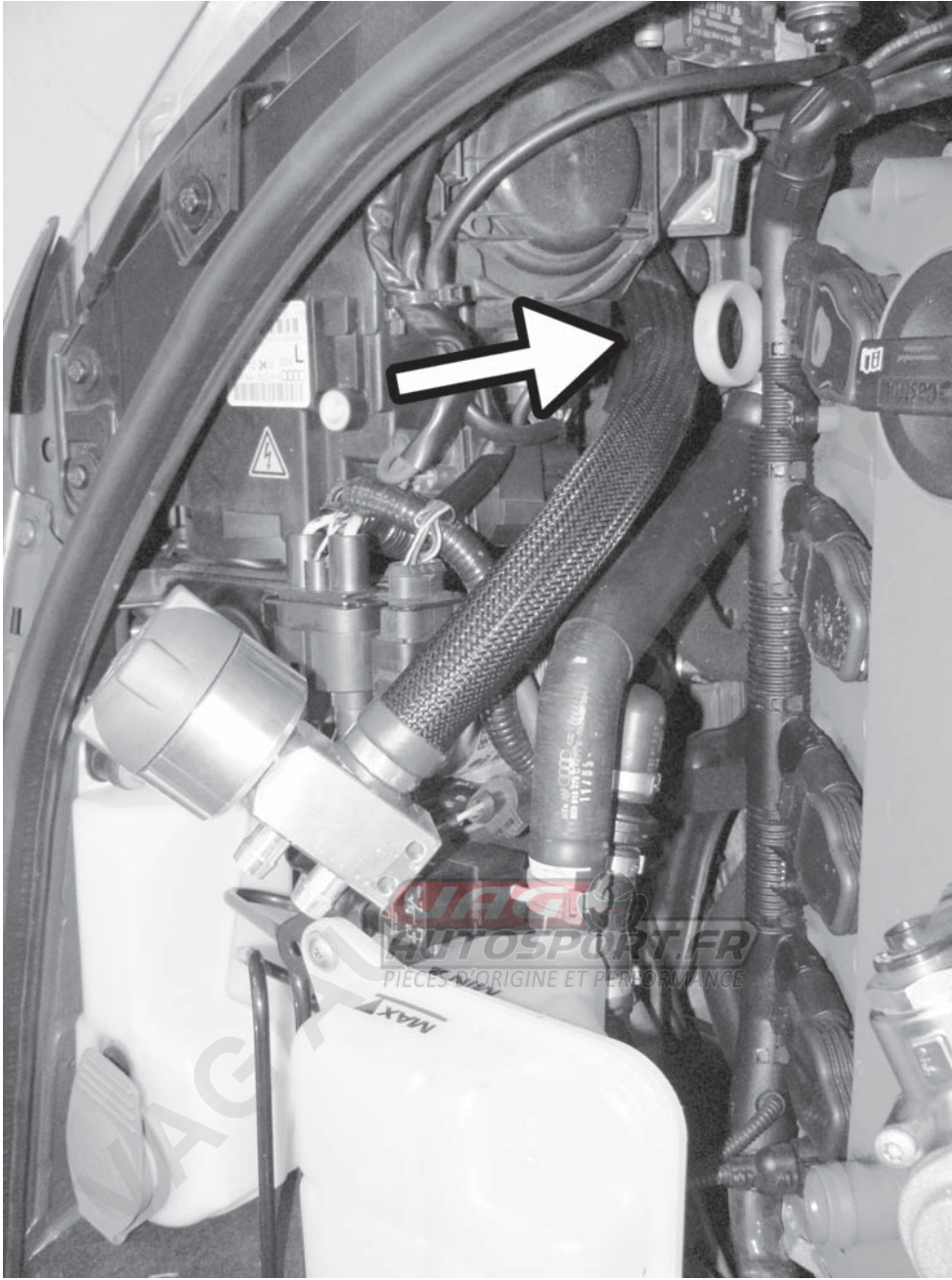

Created with

 **nitro** PDF[®] professional

download the free trial online at nitropdf.com/professional

APR, LLC
4800 US HWY 280 West Opelika Alabama 36801

132) Route the coolant line behind the side radiator air duct and underneath the bumper crash beam. Connect to the APR radiator as shown with the supplied clamp. Make sure the line is not kinked or crushed anywhere.

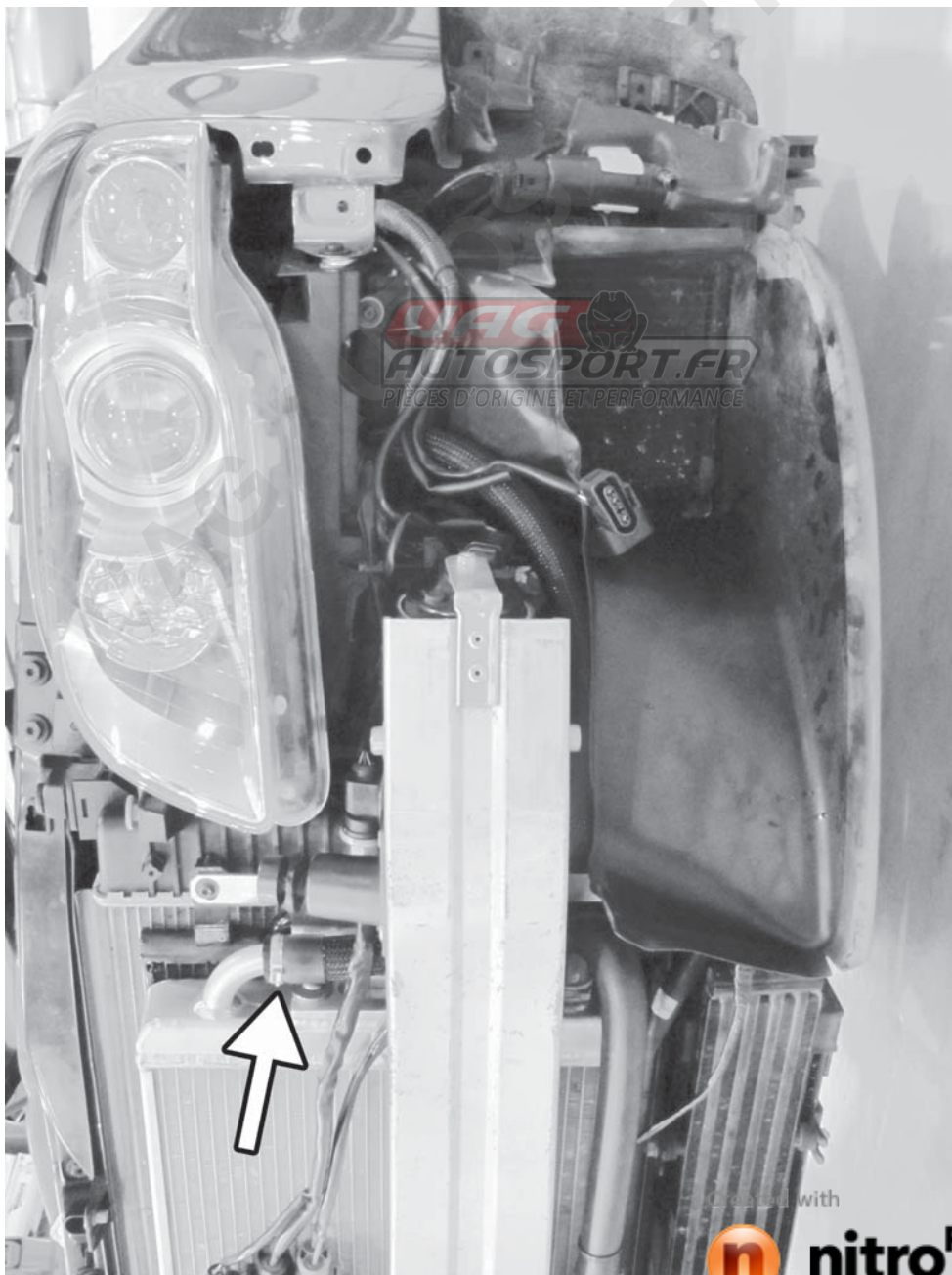

APR, LLC
Alabama 36801
4800 US HWY 280 West Opelika

133) Connect the two remaining coolant lines to the APR coolant reservoir. Make sure the longer line is connected to the upper port on the reservoir. Install supplied hose clamps and crimp closed.

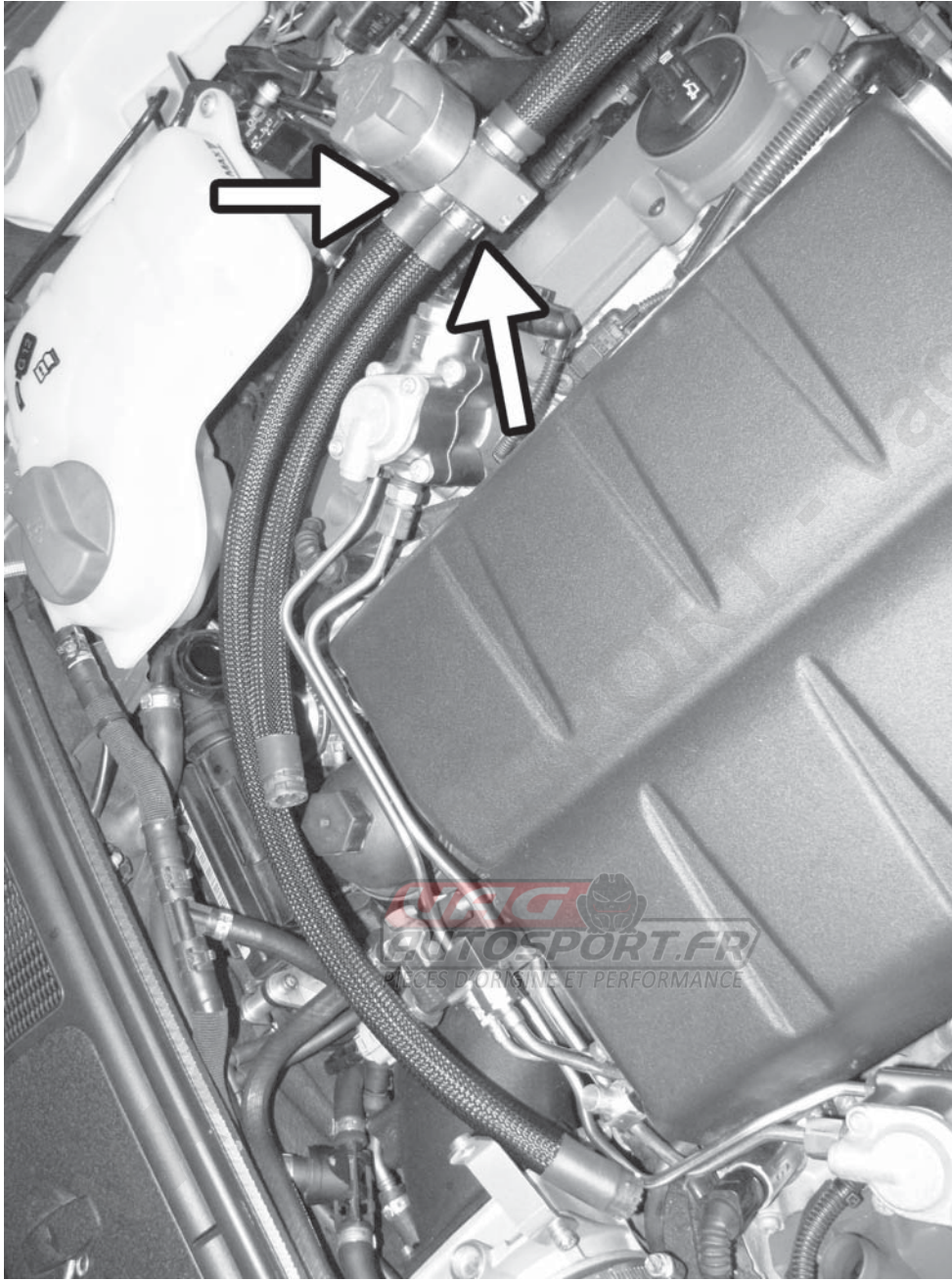

Created with

 **nitro** PDF[®] professional

download the free trial online at nitropdf.com/professional

APR, LLC
4800 US HWY 280 West Opelika Alabama 36801

134) Connect the APR coolant reservoir bracket to the vacuum pump bracket with the supplied 10mm bolts, nuts, and washers.

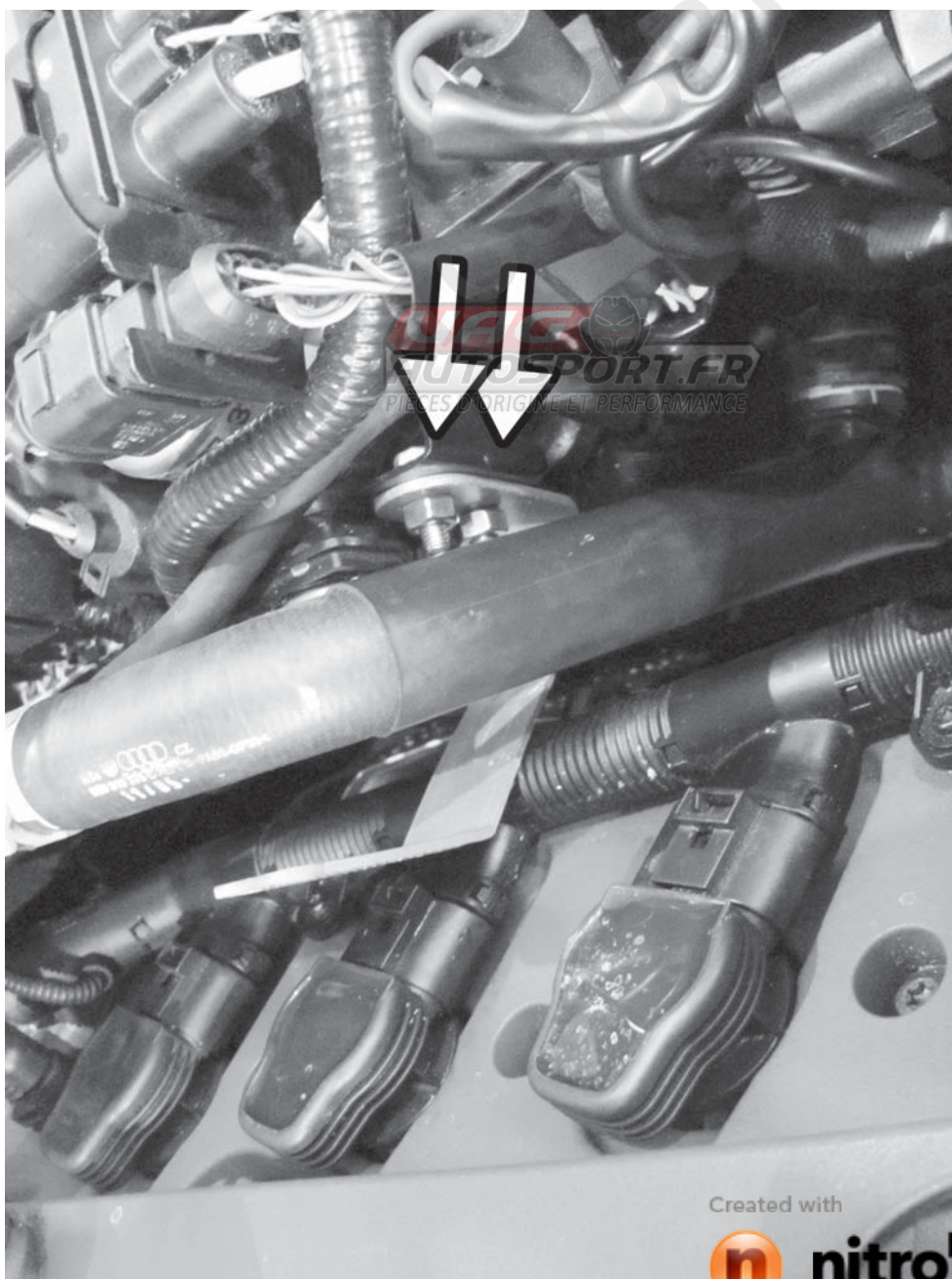

APR, LLC
4800 US HWY 280 West Opelika Alabama 36801

Created with

 **nitro** PDF[®] professional

download the free trial online at nitropdf.com/professional

135) Connect the APR coolant reservoir to the APR bracket with the supplied 10mm bolts, nuts, and washers.

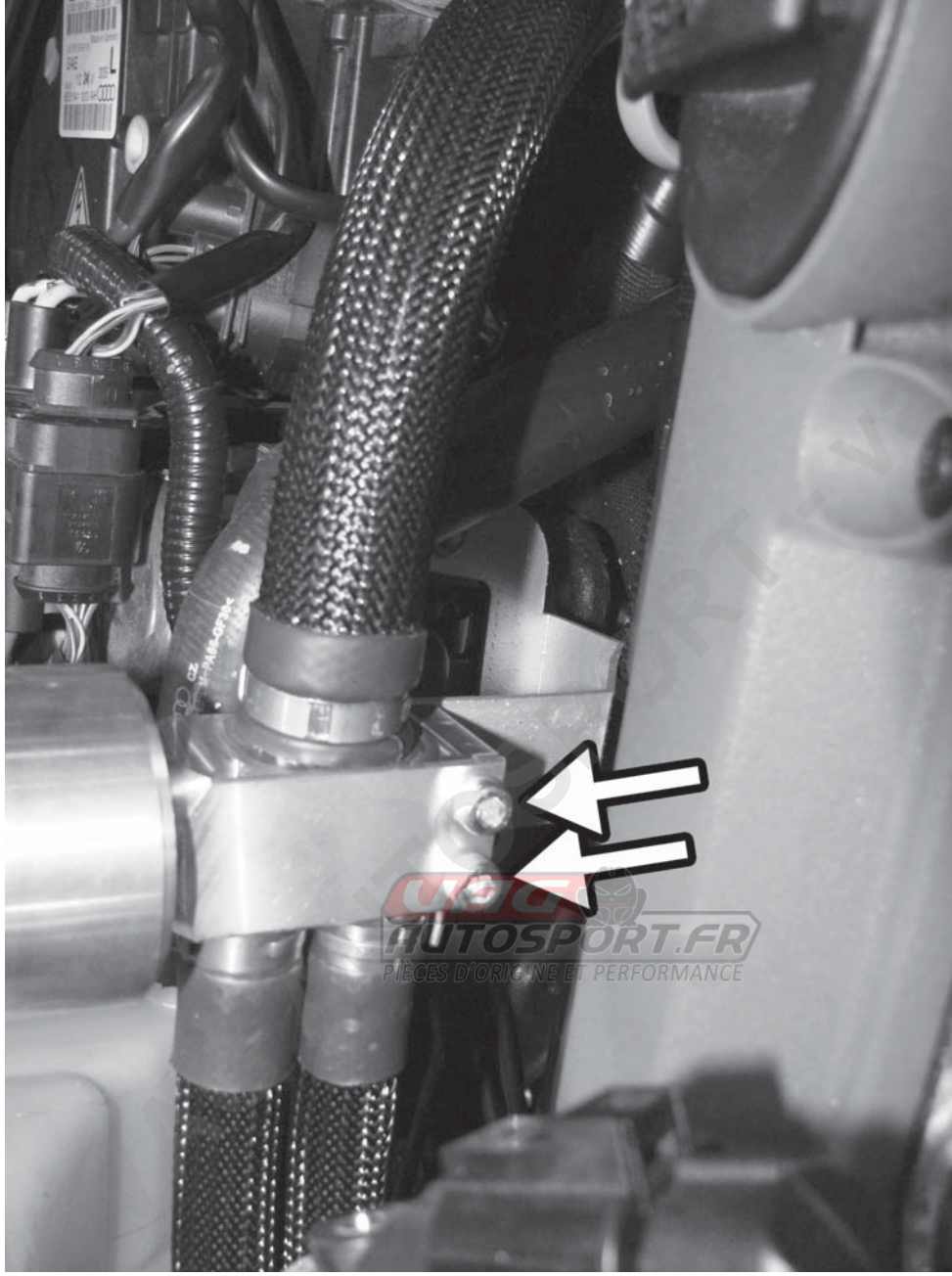

Created with



nitro PDF[®]

professional

download the free trial online at nitropdf.com/professional

APR, LLC
4800 US HWY 280 West Opelika Alabama 36801

136) After confirming the stock crush washers are removed from the HPFP, install the supplied conical crush washers with the flat face of the washer facing the pump.

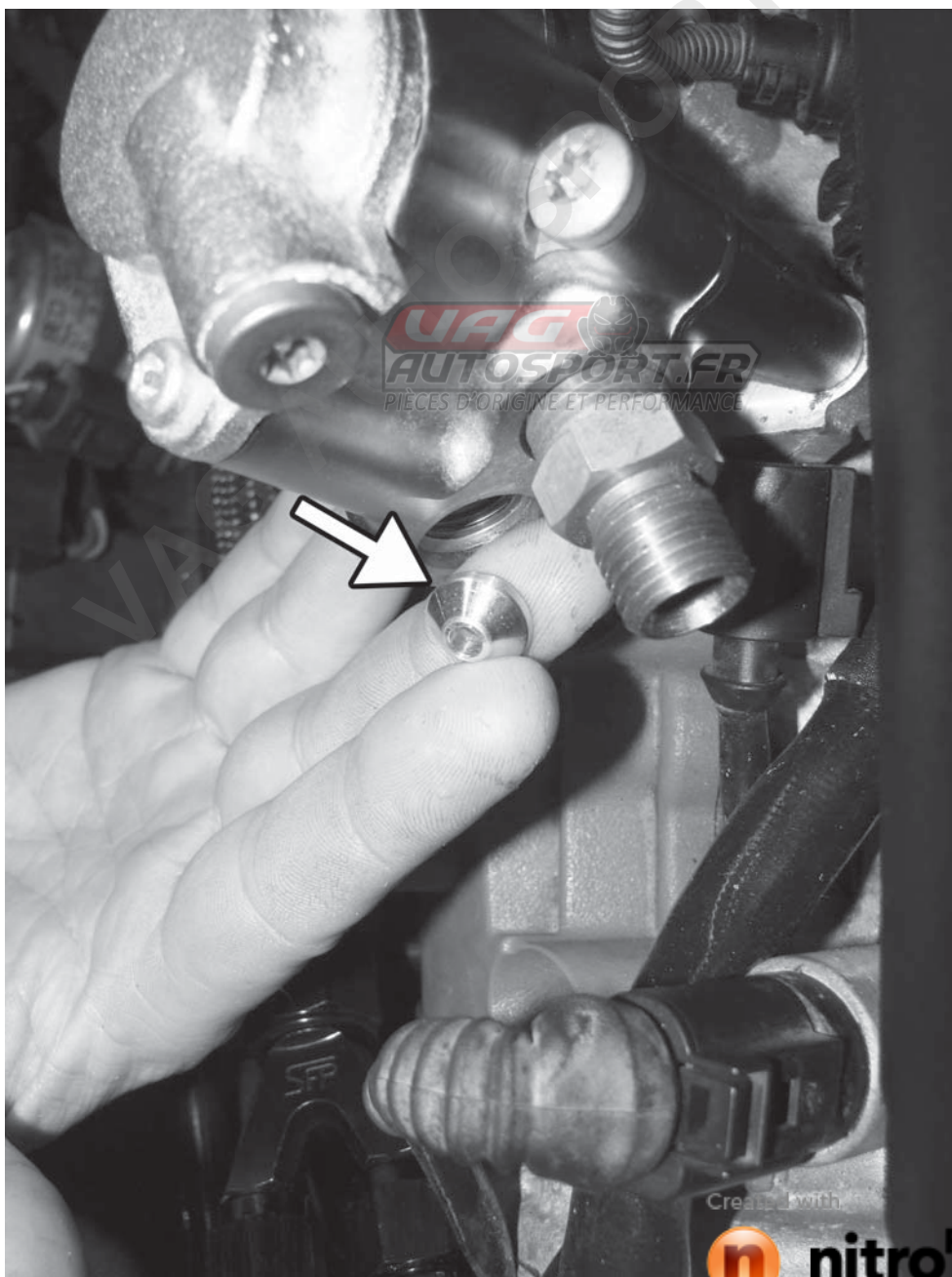

APR, LLC
Alabama 36801
4800 US HWY 280 West Opelika

137) Loosely install the supplied bracket on the APR high pressure fuel lines with the two included 5MM allen screws and lockwashers.



Created with



nitro PDF[®]

professional

download the free trial online at nitropdf.com/professional

APR, LLC

4800 US HWY 280 West Opelika Alabama 36801

138) Install the APR fuel lines in the car and hand tighten all six connections.

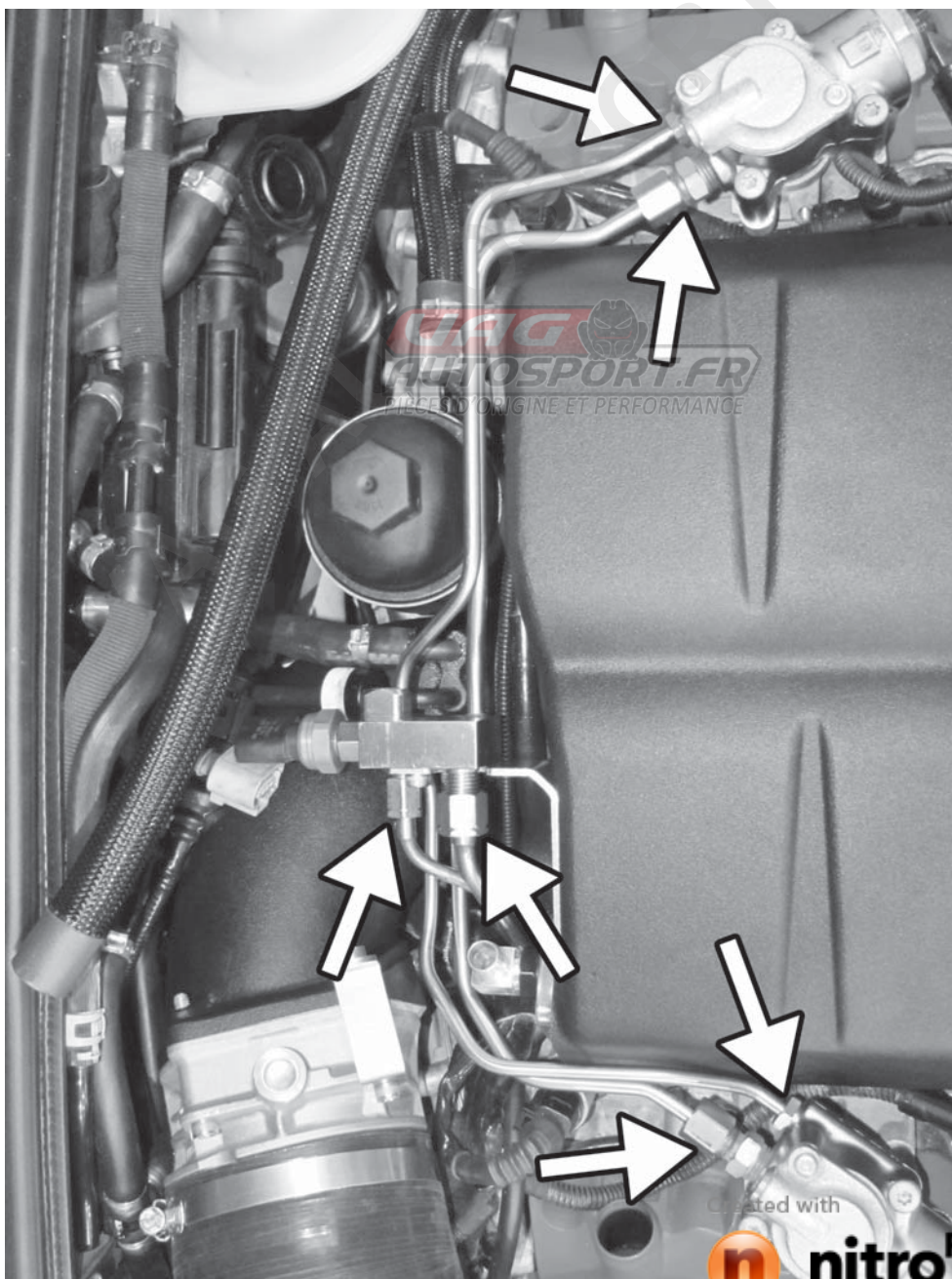

APR, LLC
4800 US HWY 280 West Opelika Alabama 36801

139) Connect the fuel rail support bracket to the supercharger assembly with the supplied 5MM allen screws and lockwashers. Tighten the four 5MM allen screws. Install the low pressure fuel sensor with a 24MM wrench and reconnect the electrical connector to the low pressure fuel sensor.

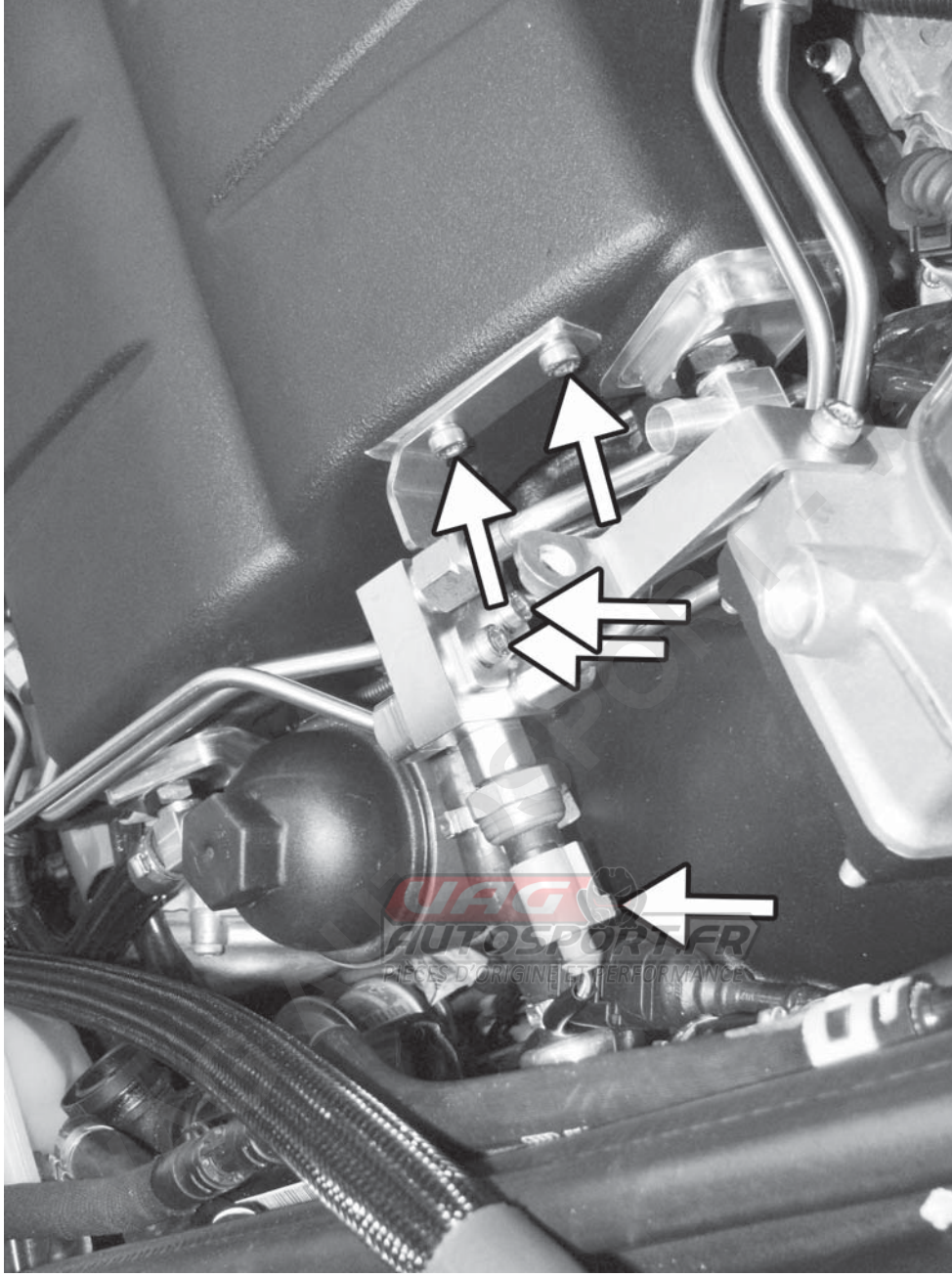

Created with



nitro PDF[®]

professional

download the free trial online at nitropdf.com/professional

APR, LLC
4800 US HWY 280 West Opelika Alabama 36801

140) Cut the stock fuel feed line to the fuel rail to length, and install the supplied banjo fitting and secure with a crimp clamp. Connect the fitting to the fuel distribution block with the supplied banjo bolt and crush washers.

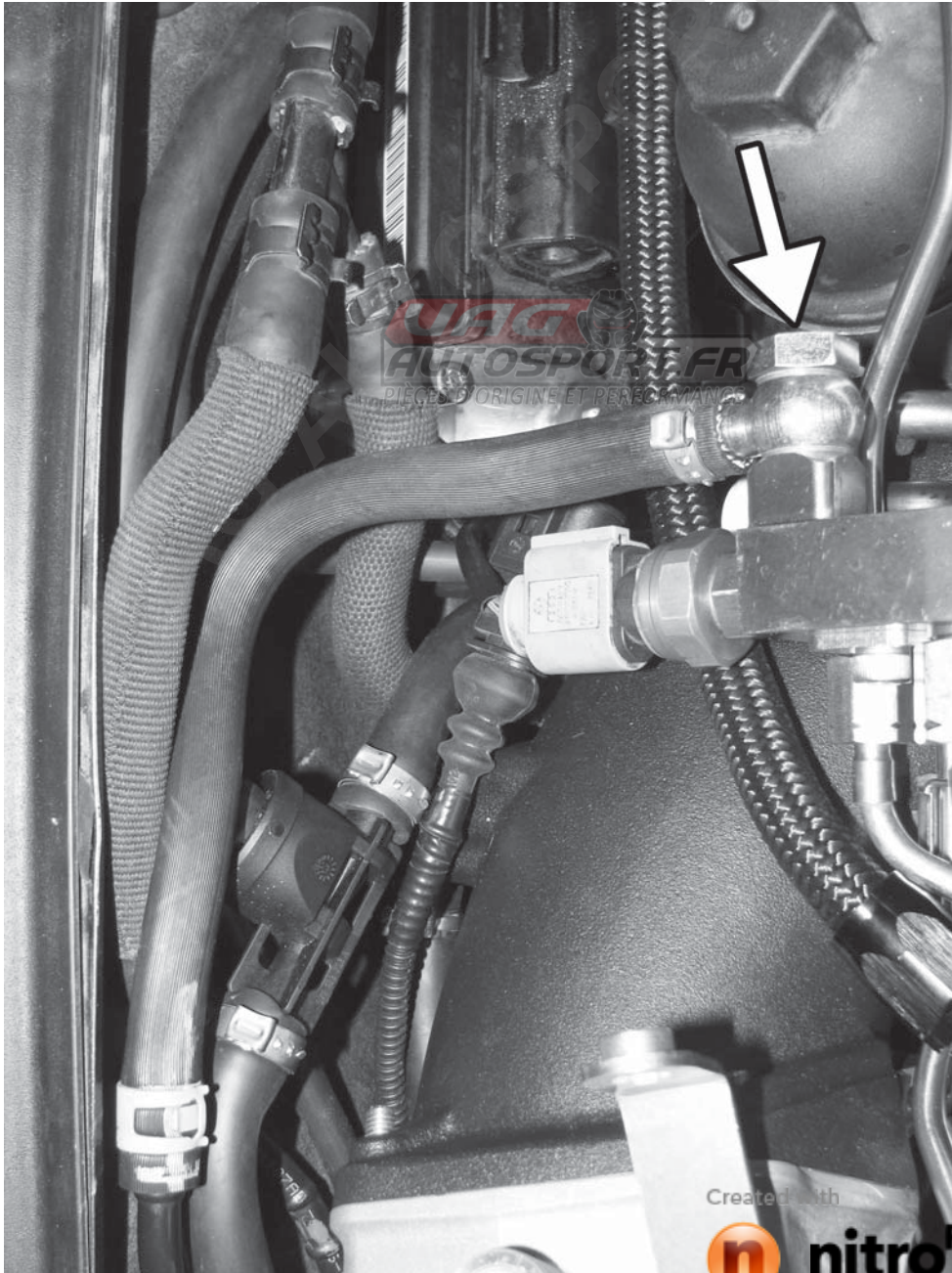

APR, LLC
4800 US HWY 280 West Opelika Alabama 36801

Created with



nitro PDF

professional

download the free trial online at nitropdf.com/professional

141) Routing over the fuel distribution block, connect the hose to the right side supercharger cooler on the back of the engine and secure with a crimp clamp.

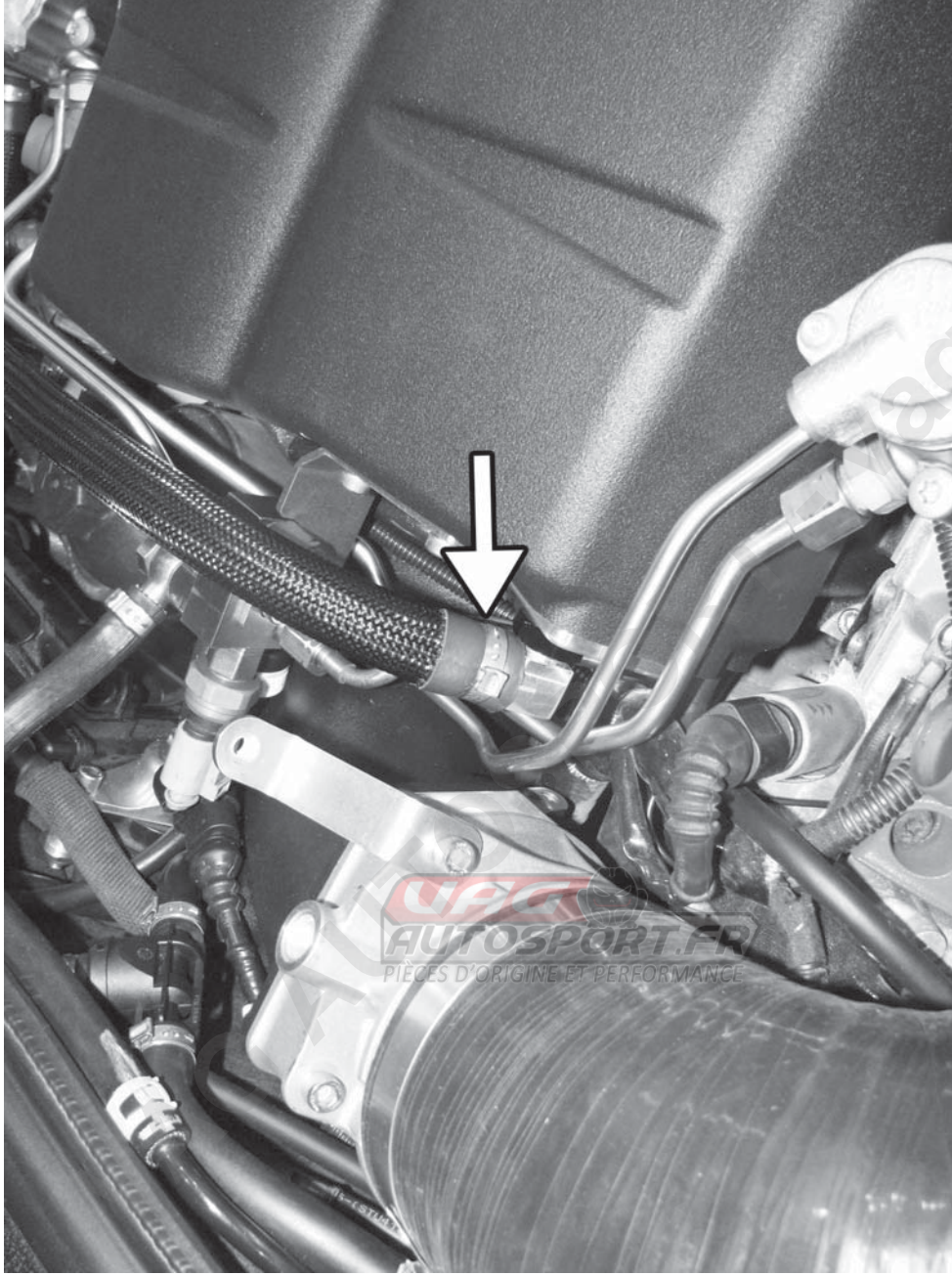

Created with



nitro PDF[®]

professional

download the free trial online at nitropdf.com/professional

APR, LLC
4800 US HWY 280 West Opelika Alabama 36801

142) Reinstall the factory PCV hose, connecting it to each valve cover and the oil separator. Install the supplied 5MM allen screw and lockwasher holding the PCV hose to the APR bracket on the throttle body.

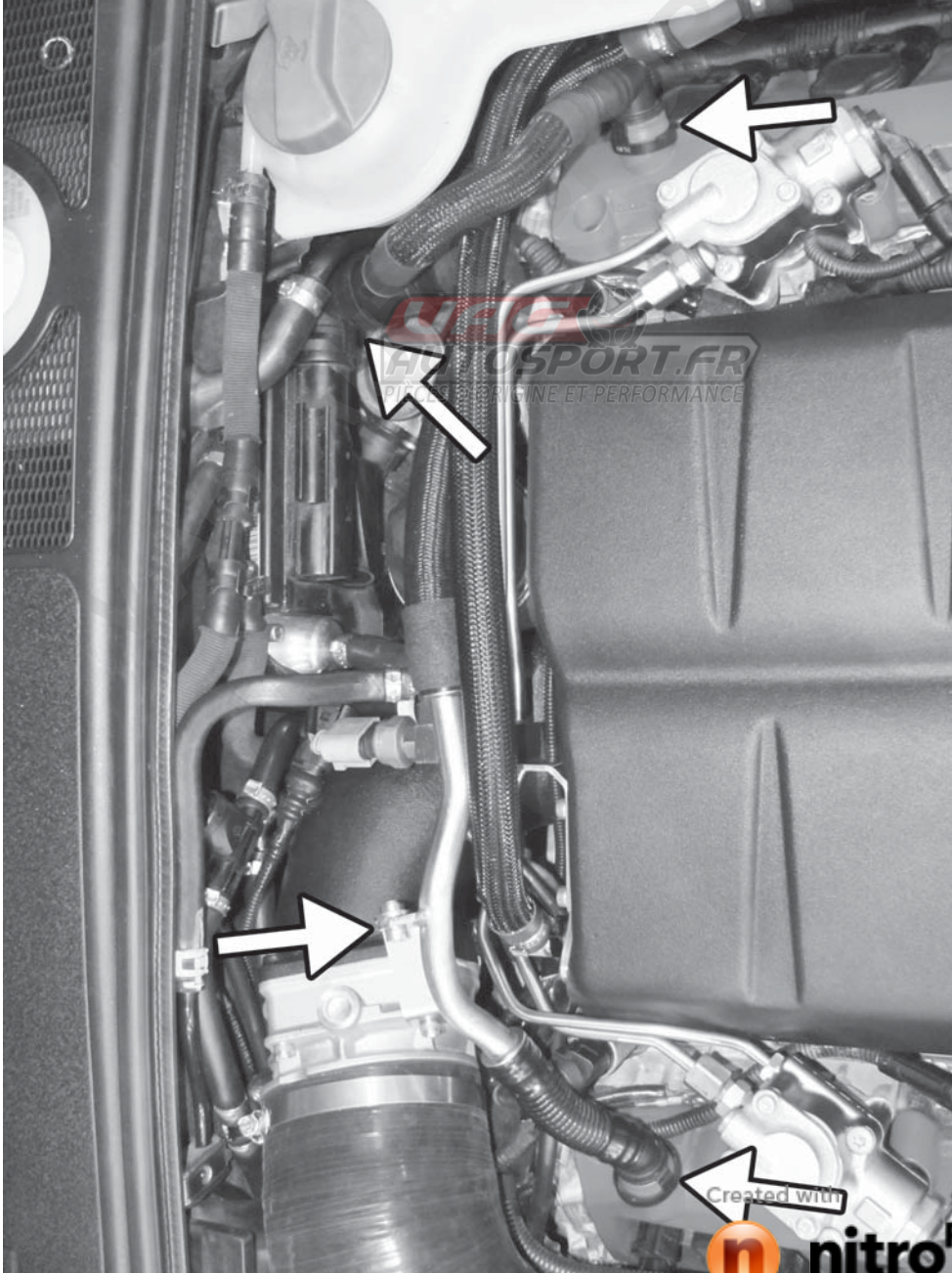

APR, LLC
4800 US HWY 280 West Opelika Alabama 36801



nitro PDF

professional

download the free trial online at nitropdf.com/professional

143) Reinstall the engine bay weather stripping and the left side engine cover with the stock 10MM screw.



Created with



nitro PDF[®]

professional

download the free trial online at nitropdf.com/professional

APR, LLC
4800 US HWY 280 West Opelika Alabama 36801

144) Connect a vacuum bleeder to the coolant expansion tank. Vacuum the cooling system and then suck the coolant into the car per the instructions of the vacuum bleeders manufacturer.

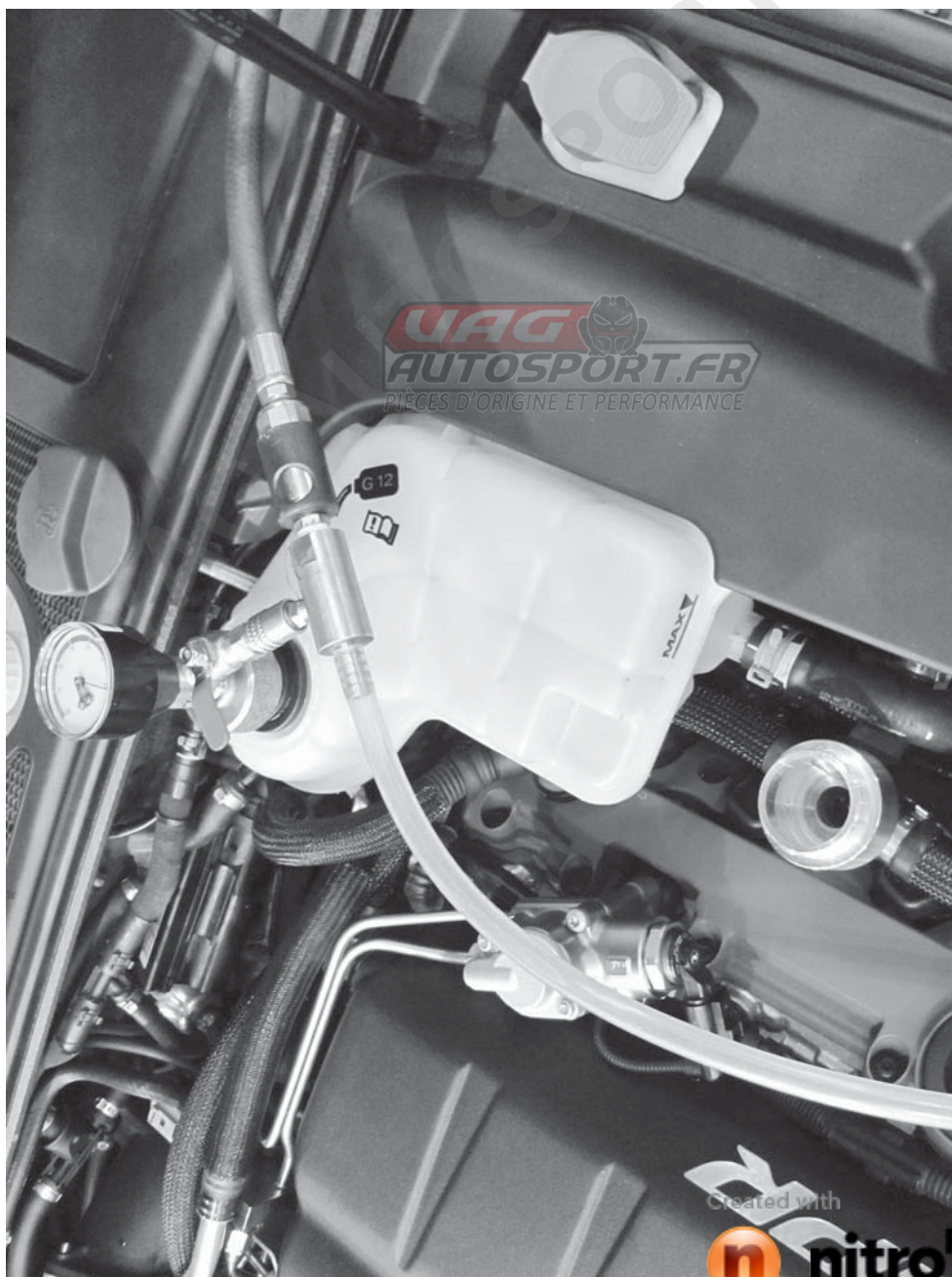

APR, LLC
Alabama 36801
4800 US HWY 280 West Opelika

Created with



nitro PDF

professional

download the free trial online at nitropdf.com/professional

145) Connect a vacuum bleeder to the APR coolant reservoir. Like the factory cooling system, vacuum the cooling system and then suck the coolant into the car per the instructions of the vacuum bleeders manufacturer. Properly bleeding the cooling system is critical to the operation of the APR coolant pump and the supercharger cooling system.

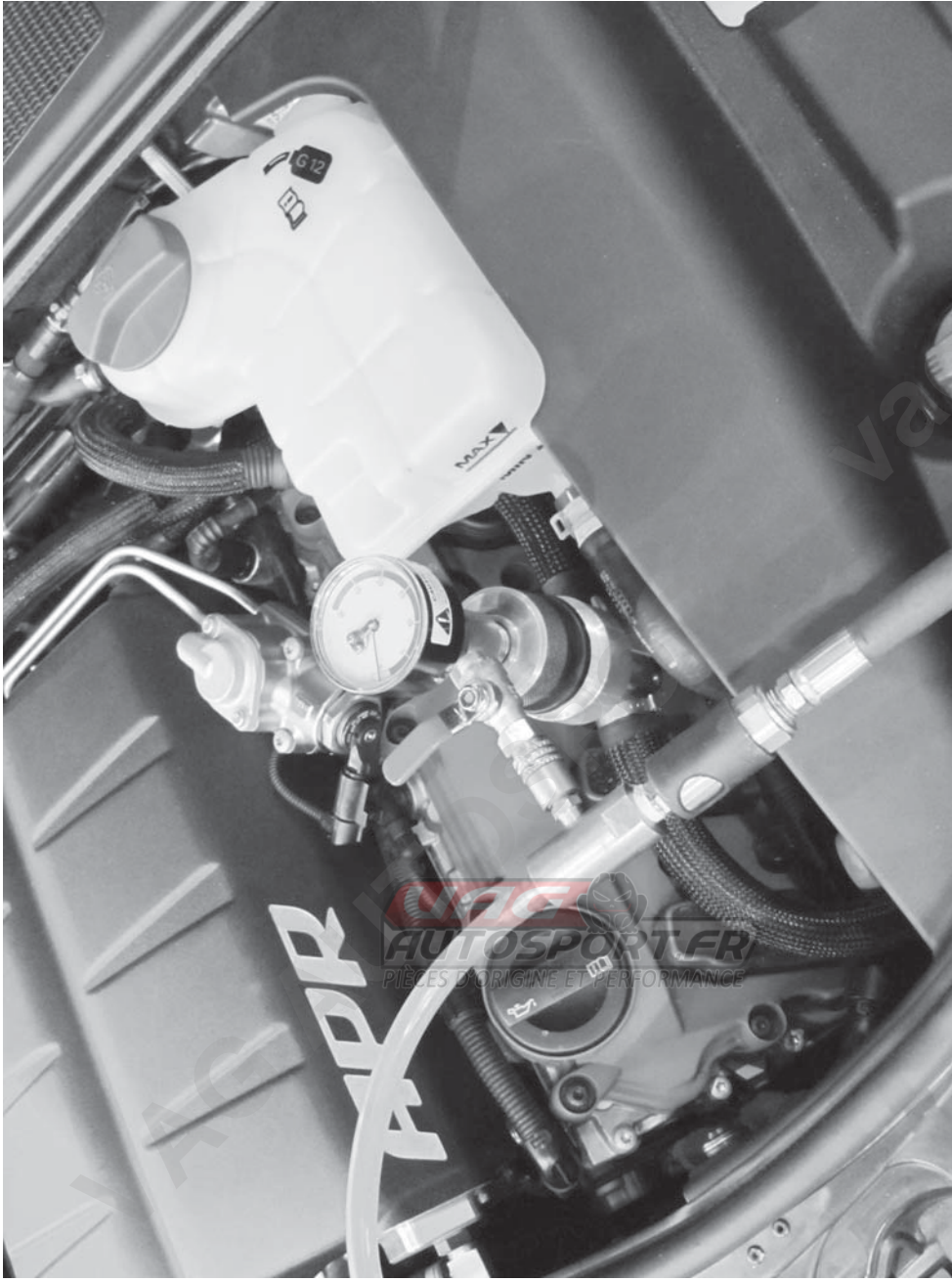

Created with



nitro PDF[®]

professional

download the free trial online at nitropdf.com/professional

APR, LLC
4800 US HWY 280 West Opelika Alabama 36801

146) With a helper, bring the front bumper close to the car and reconnect the headlight washer pump. Be sure to refill the headlight washer tank.

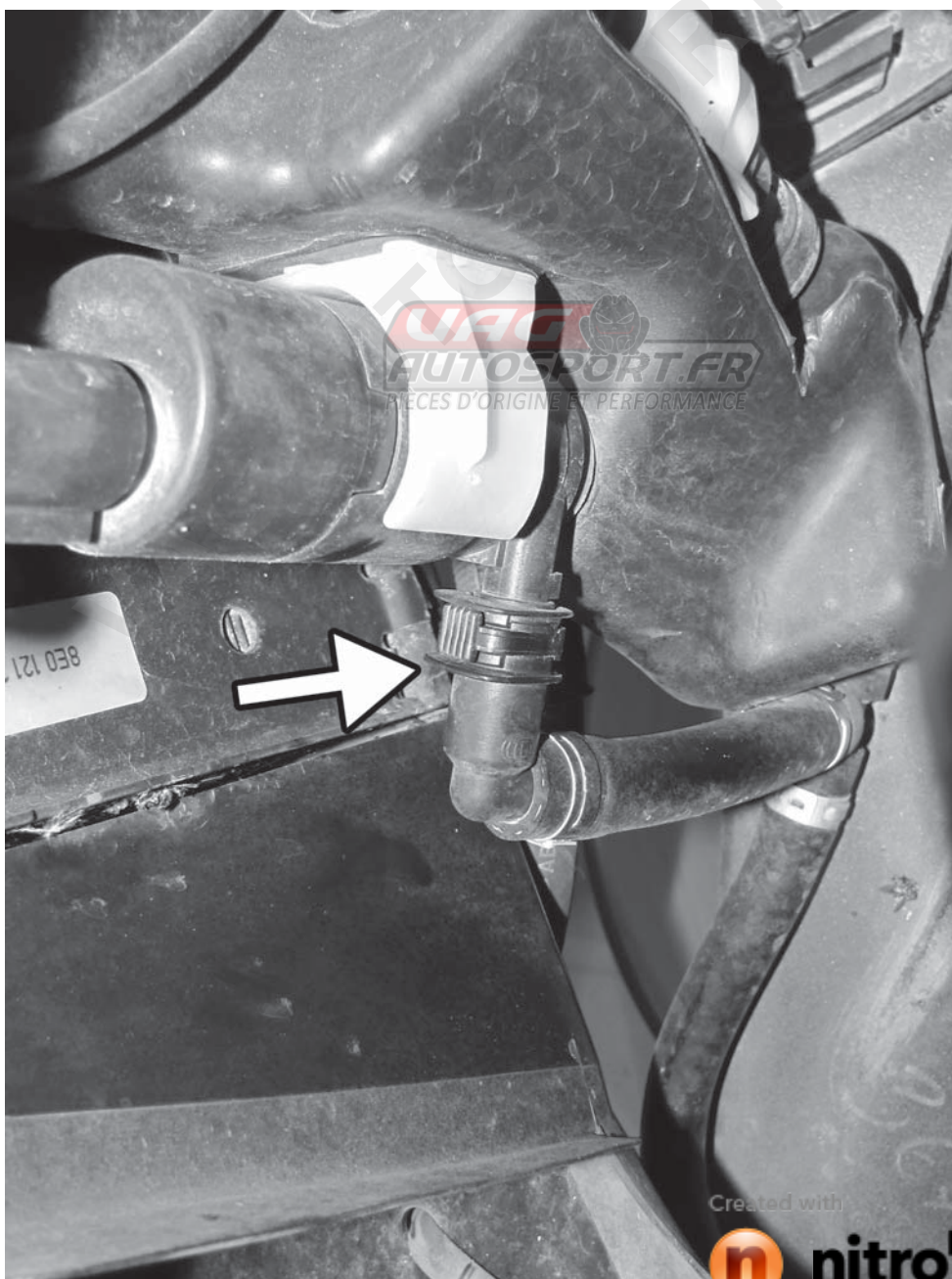

APR, LLC
Alabama 36801
4800 US HWY 280 West Opelika

Created with

 nitro PDF professional

download the free trial online at nitropdf.com/professional

147) Reconnect the three electrical connections on the left side of the bumper cover.

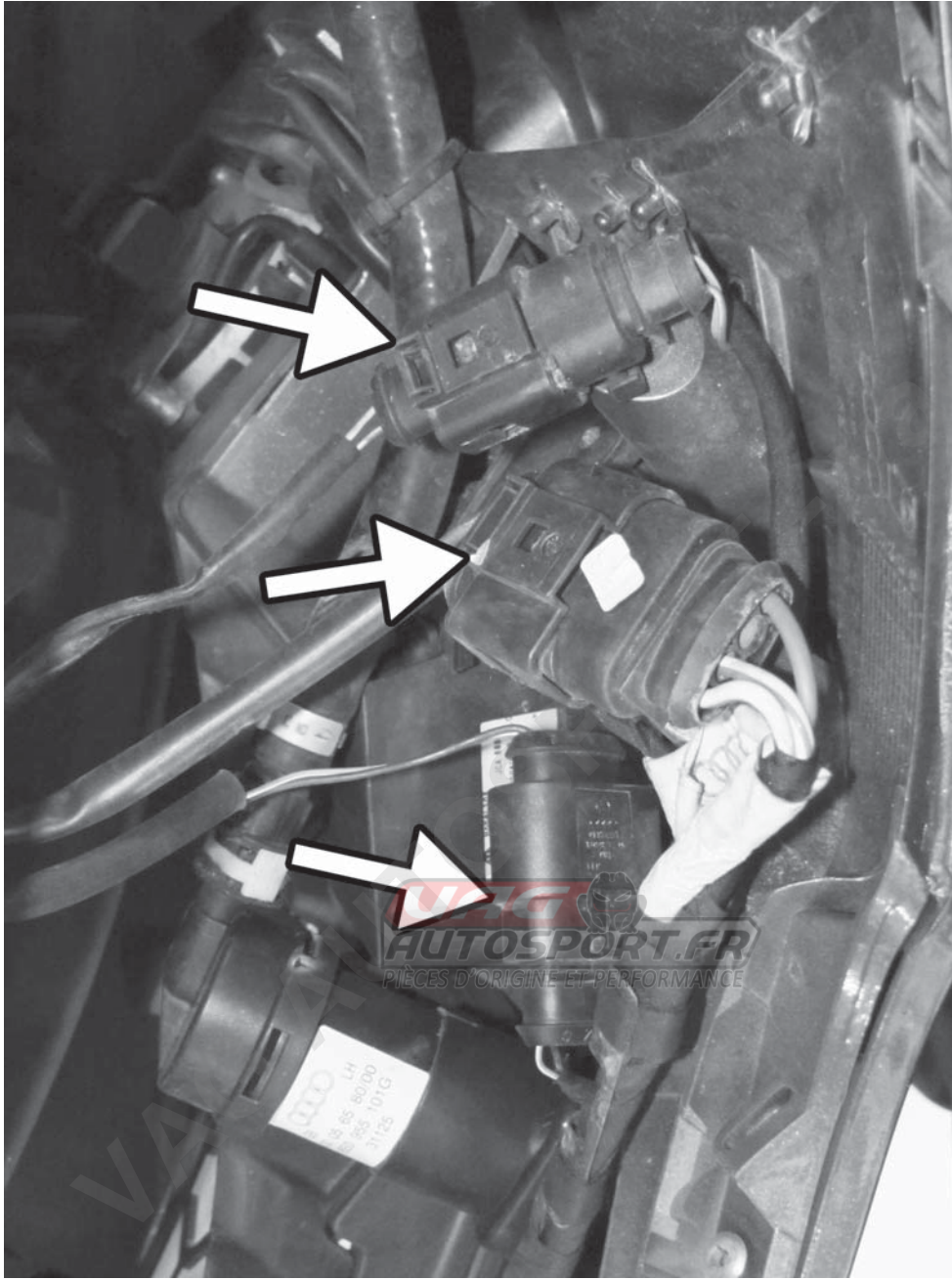

Created with

 **nitro** PDF[®] professional

download the free trial online at nitropdf.com/professional

APR, LLC
4800 US HWY 280 West Opelika Alabama 36801

148) Bring the bumper close to the fenders of the car. Be very careful not to scratch the paint with the mounting studs of the cover. Line the screw holes up and slide the bumper in place.



APR, LLC
Alabama 36801
4800 US HWY 280 West Opelika

Created with



nitro PDF

professional

download the free trial online at nitropdf.com/professional

149) Reinstall the two T30 screws in the top of the bumper cover. These screws connect the bumper to the bumper crash beam.

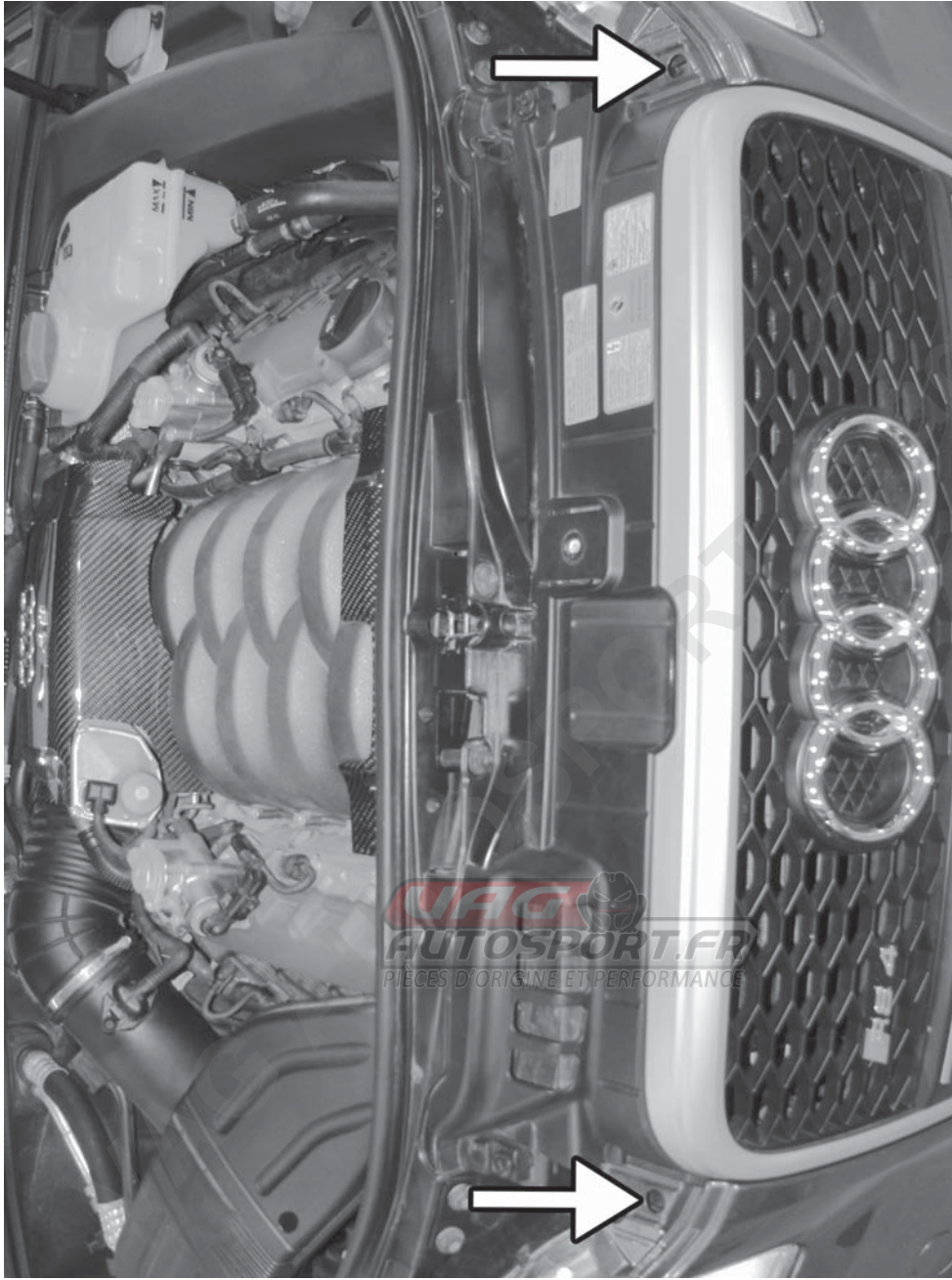

Created with



nitro PDF[®]

professional

download the free trial online at nitropdf.com/professional

APR, LLC
4800 US HWY 280 West Opelika Alabama 36801

150) Reinstall the four (two on each side) 10MM nuts that connect the fender to the front bumper cover mounting studs.

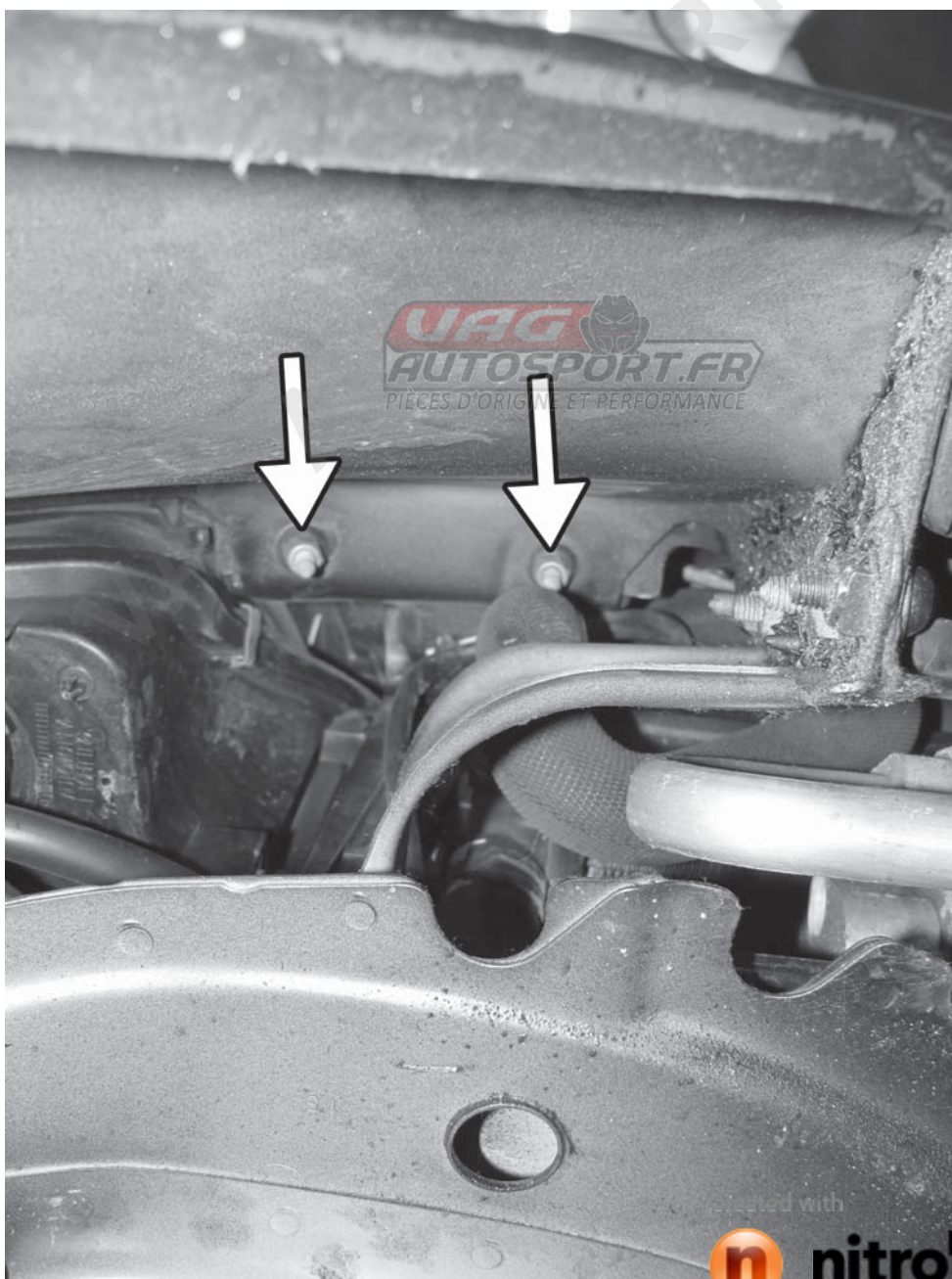

APR, LLC
Alabama 36801
4800 US HWY 280 West Opelika



nitro PDF

professional

download the free trial online at nitropdf.com/professional

151) Reinstall the four (two on each side) T25 torx screws that connect the end of the bumper cover to the fender, as well as the bumper cover to the support brace.

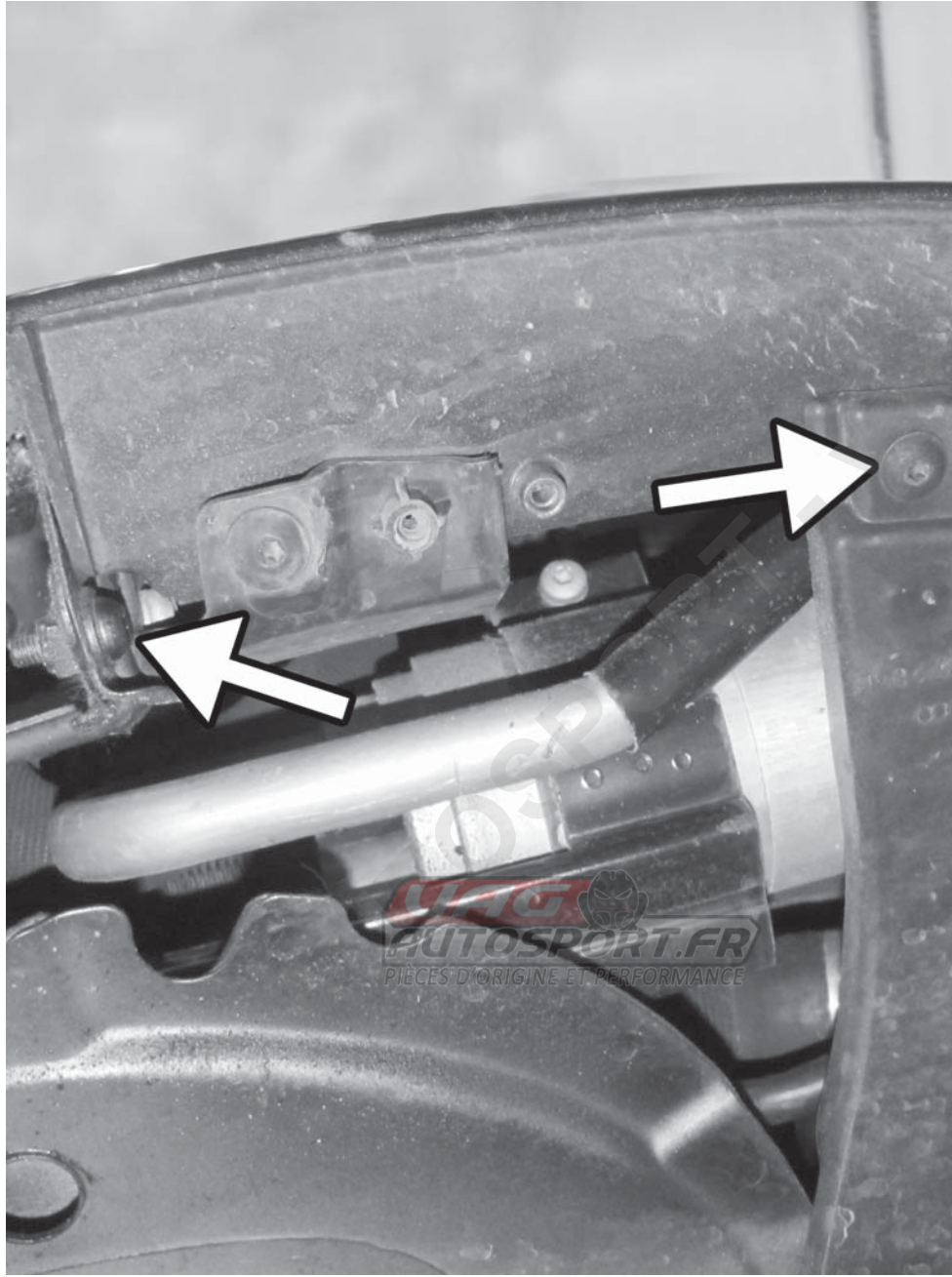

Created with



nitro PDF[®]

professional

download the free trial online at nitropdf.com/professional

APR, LLC
4800 US HWY 280 West Opelika Alabama 36801

152) Reinstall the quick release fasteners and screws that hold the belly pan in place.

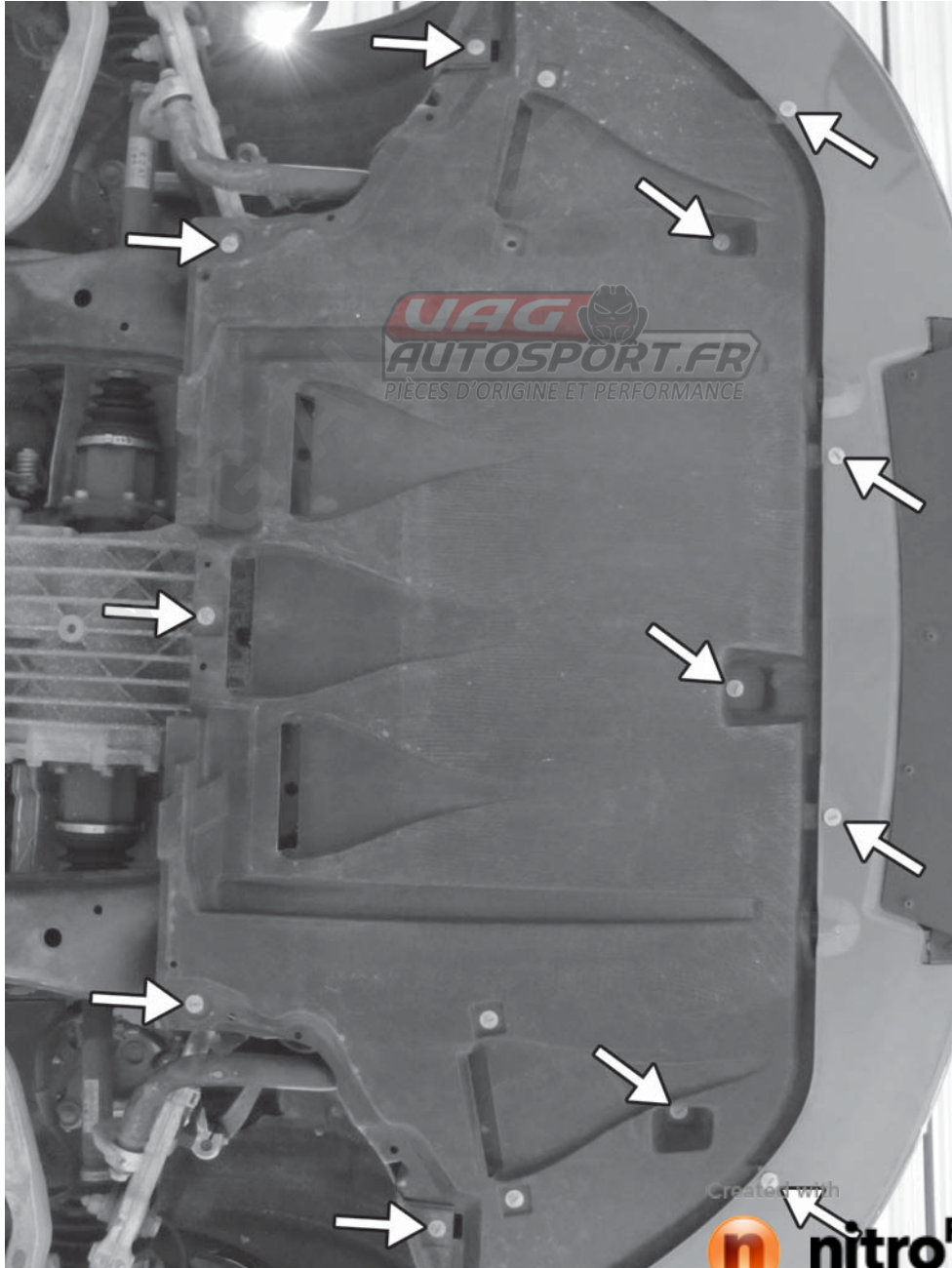

153) Reinstall the fender liner, connecting the six (three on each side) T25 torx screws on the brake cooling ducts, the fourteen (seven on each side) T25 torx screws on the fender liner, and the four (two on each side) push tabs.

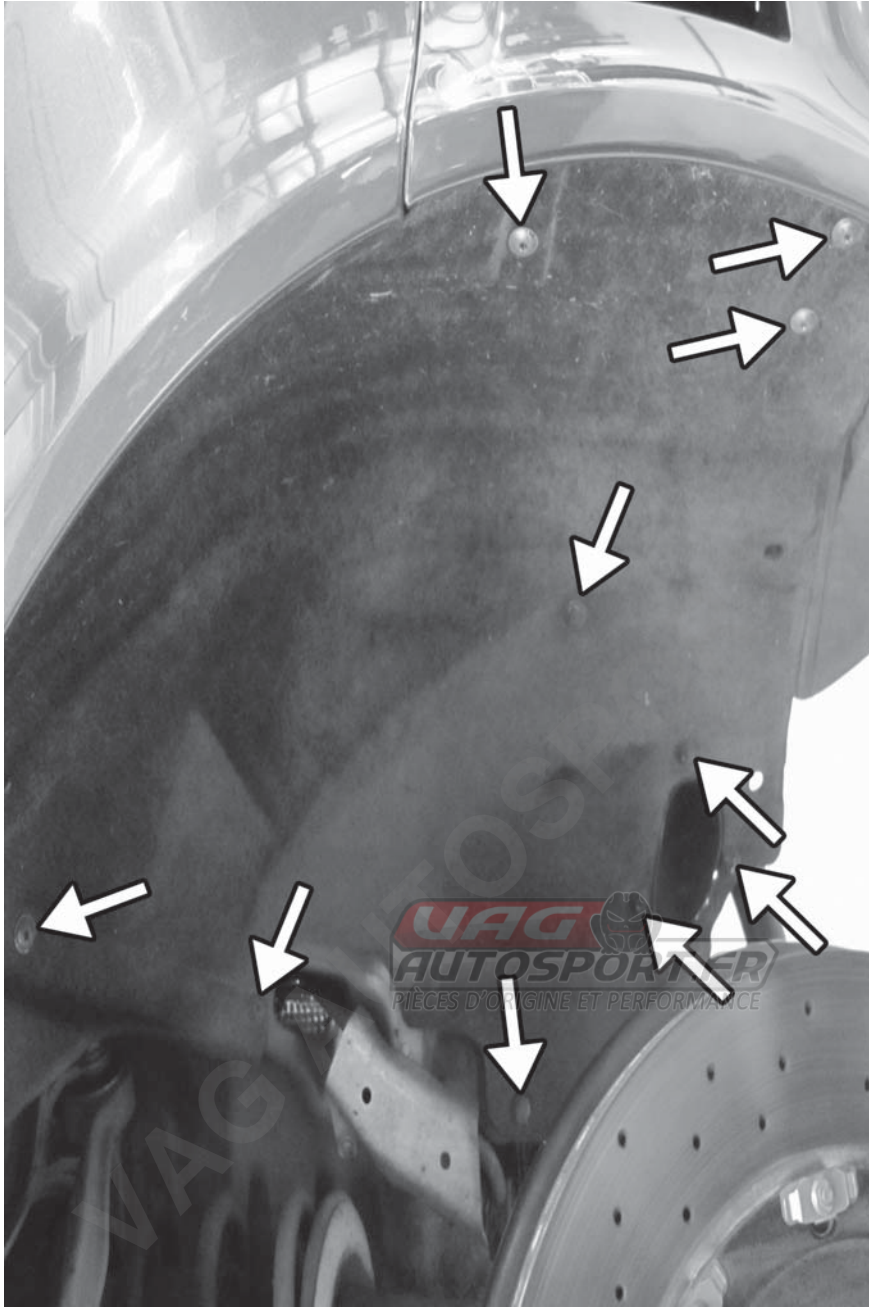

Created with



nitroPDF[®]

professional

download the free trial online at nitropdf.com/professional

APR, LLC
4800 US HWY 280 West Opelika Alabama 36801

154) Reinstall the three T30 torx screws from the upper part of the front bumper.



APR, LLC
Alabama 36801
4800 US HWY 280 West Opelika

Created with



nitro PDF[®]

professional

download the free trial online at nitropdf.com/professional

VAG AUTOSPORT - vag-autosport



APR, LLC
4800 US HWY 280 West Opelika Alabama 36801

Created with



download the free trial online at nitropdf.com/professional