

2.5TFSI
TTRS



VAG
AUTOSPORT.FR
PIÈCES D'ORIGINE ET PERFORMANCE

TTRS STAGE 3 TURBO KIT/INSTALLATION INSTRUCTIONS

APR

VAG AUTOSPORT - vag-auto



APR, LLC

4800 US HWY 280 West Opelika, AL 36801

+1.334.502.5181

www.goapr.com

NOTES:

Before attempting to install an APR Stage III Upgrade yourself, ask yourself if you think you are up to the task. While fairly straightforward, this is an extensive kit and will take a novice mechanic more than a weekend to install. Also be aware that the ECU needs to be sent to APR to be programmed, so you will need to plan appropriate time for shipping.

These instructions were written for a left hand drive, North American specification TT-RS, but other variations are similar. If you are working on a different model, you may want to double check the torque specifications for some of the factory hardware.

These instructions assume that you have basic mechanical skills and several varieties of the tools listed in order to install the kit. If you have any questions about the install, feel free to contact your APR representative.

While your friend's dad may have an "awesome set of tools", there are several specialty items that may not be in your average mechanics toolbox. In addition to basic mechanics tools (metric and standard socket sets, screwdrivers, hand tools, etc.), the following items listed below are needed:

Sockets: T25 Torx, T30 Torx, 8mm Triple Square, 10mm Triple Square, 24mm 12 point, 4mm Allen, 5mm Allen, 6mm Ball Head Allen, 6mm 1/4" drive Allen, 10mm External Torx, 8" 3/8" drive Wobble Extension, Spark Plug Socket, Crimp Clamp Crimpers

When disassembling the car, be sure to keep and mark all fasteners so they can be reused if needed. It is recommended that you get some kind of compartmented tray to organize the fasteners, such as a fishing tackle box or several large ice cube trays. Fasteners are referred to by the type of tool used to remove them. A factory bolt kit that replaces all the factory bolts that should be replaced (i.e.-torque-to-yield bolts) when doing this install is available from APR.

Be aware that when a direction is being indicated, such as left, right, front, rear, etc., these are being referred to as Audi refers to the parts themselves.

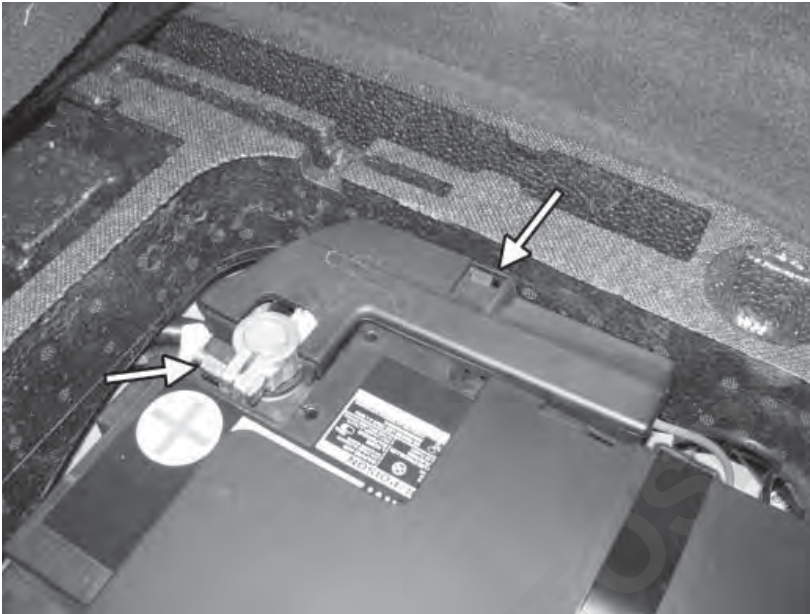

1) Support the car on jack stands or a lift. Open the trunk and disconnect the 10mm negative battery terminal. You will need to remove the plastic cover over the terminal to remove the connection.



2) Remove both front wheels and remove the center cap. Reinstall the wheels and put the car on the ground. Break loose the 24mm 12-point axle bolt. Raise the car again and remove the wheels.

3) Remove the thirteen T25 screws from the front plastic belly pan of the car, and remove it from the vehicle.

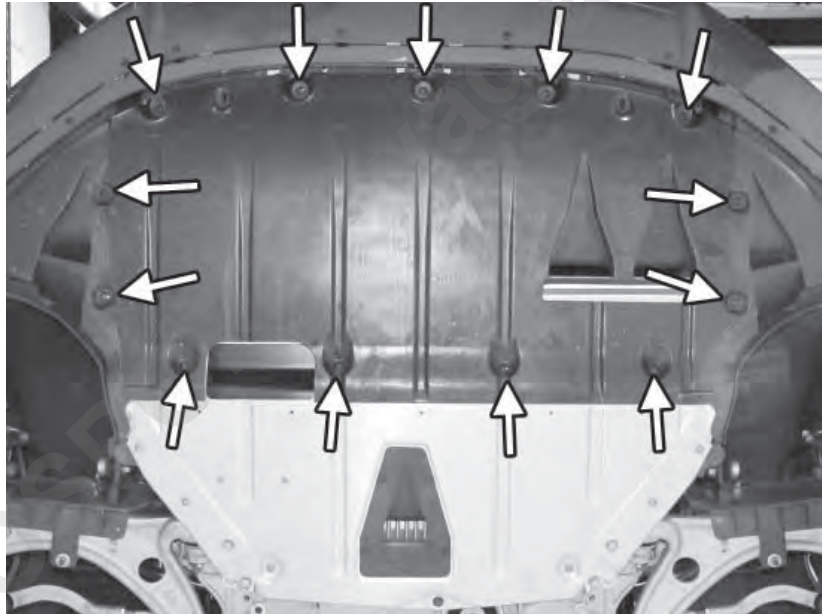

4) Remove the one T25 screw and one T30 screw from the front part of the lower fender liners on both sides.

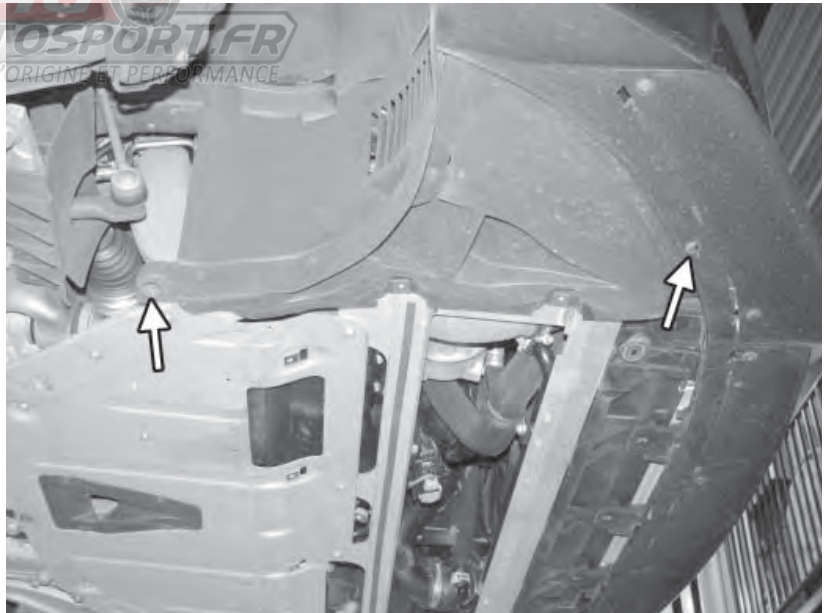

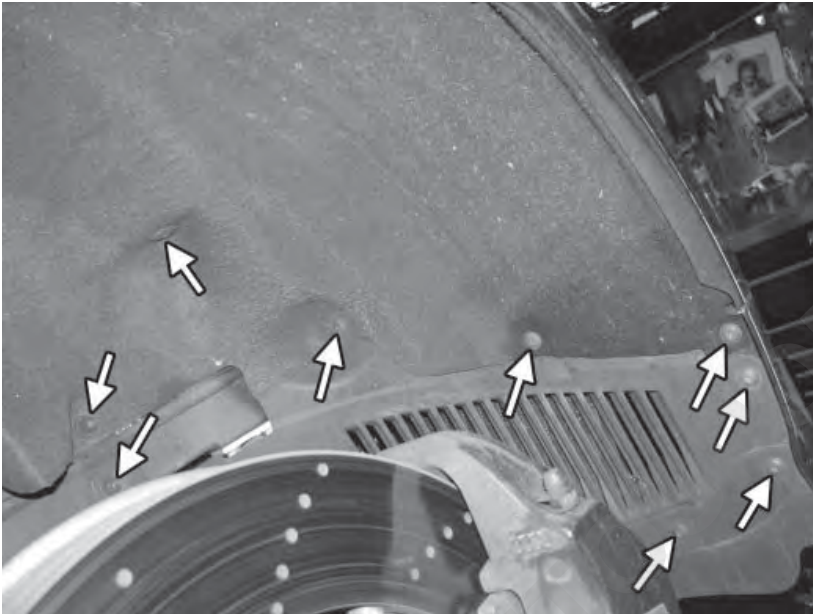

5) From inside the front side of the fender liner, remove (Left to Right) the two 10mm nuts, the one pushpin plastic fastener, and the six T25 screws. Fold the fender liner back to where it is out of the way.

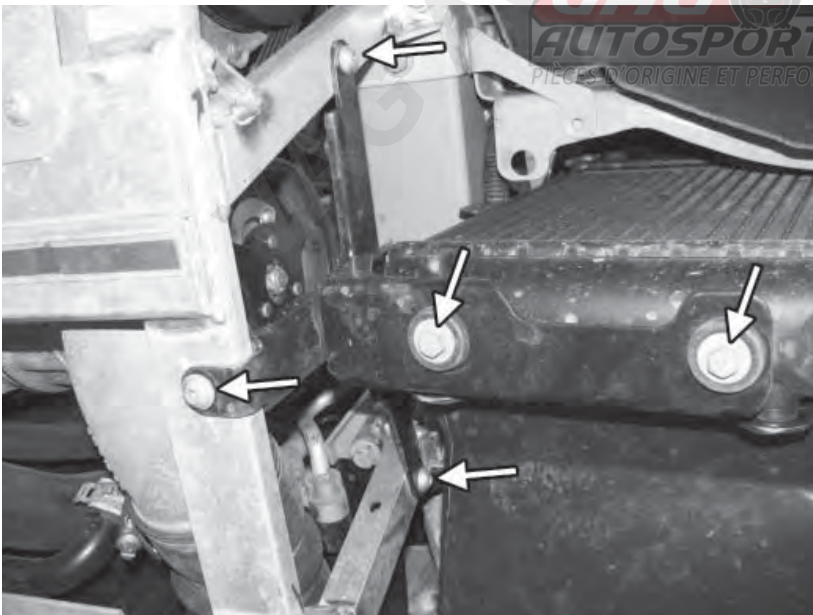

6) Remove the three T30 Torx screws and two 10mm screws that hold the lower side radiator mount to the car, and remove the mount from the car.

7) Remove the five T30 Torx screws that connect the radiator core support to the belly pan mounting frame.

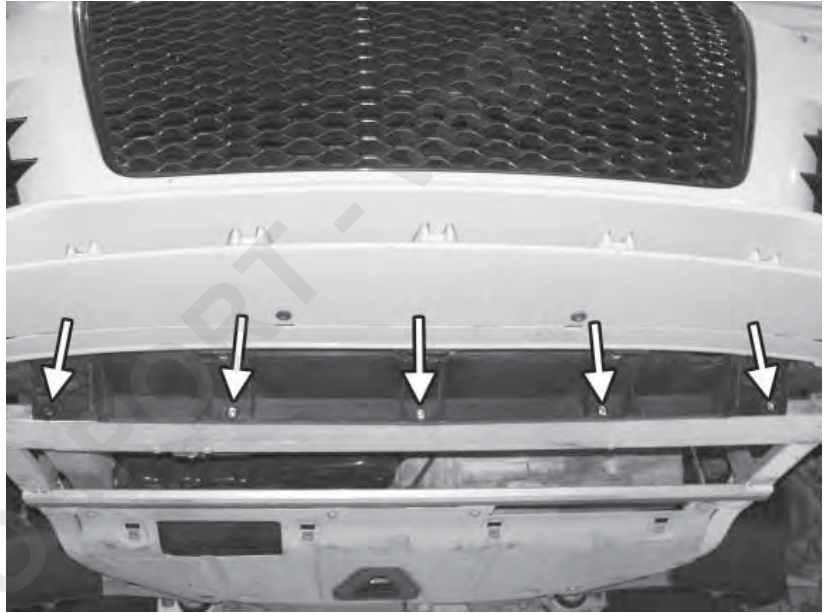

8) Remove the 8mm triple square from the rear metal belly pan, as well as the ten T30 Torx screws and remove the belly pan from the car. Also remove the three T30 Torx screws from the front of the belly pan mounting frame.

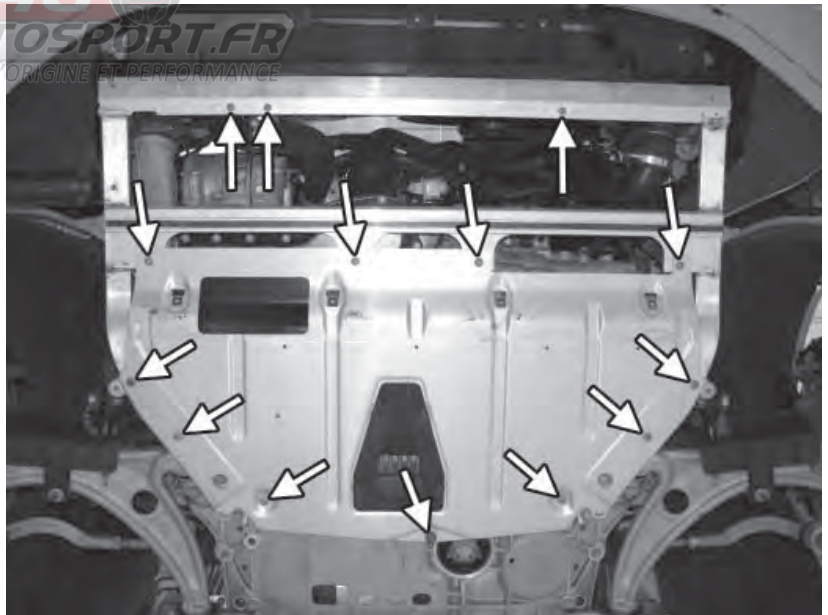

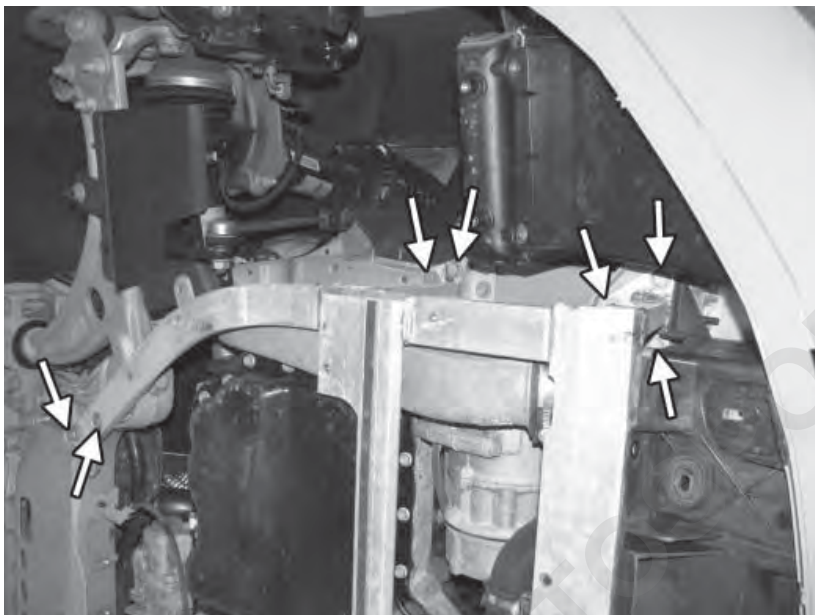

9) Remove the fourteen 13mm bolts holding the belly pan mounting frame in place, and remove the mounting frame from the car.

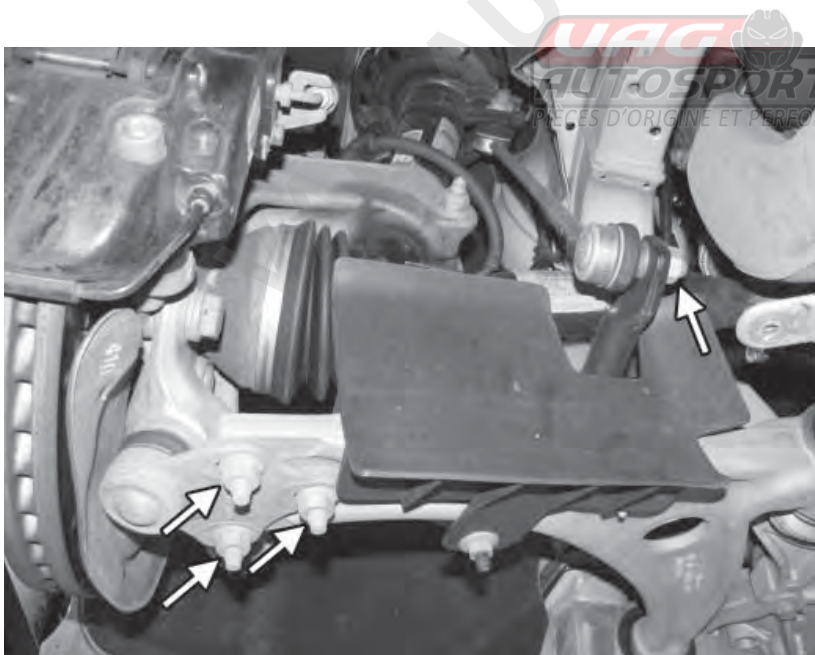

10) Remove the six (three on either side) 16mm nuts from the lower control arms and the two 18mm sway bar end links.

11) Disconnect the two electrical connectors from the ride height sensors. Remove the two 21mm nuts on the tie rod end links and separate the end links with the appropriate puller.

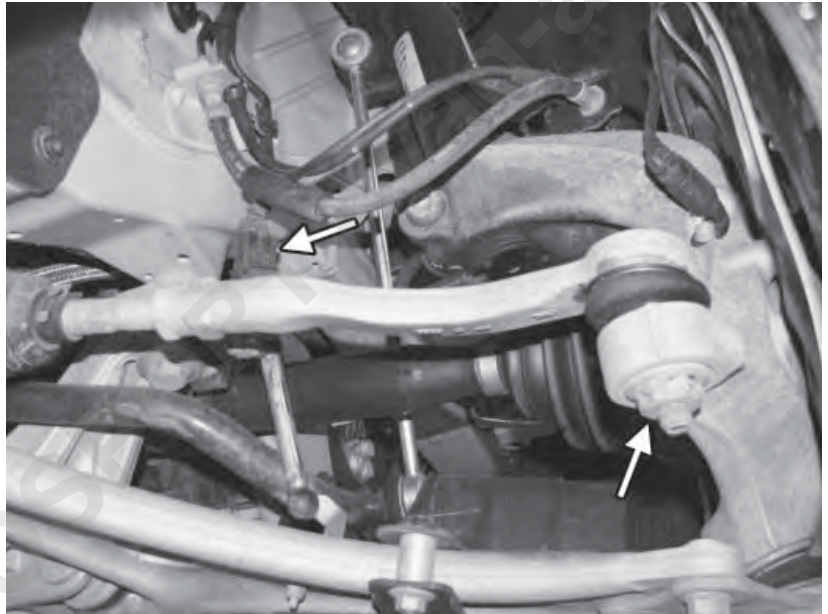

12) Remove the two 16mm and 21mm bolts from the lower center engine mount, and remove the mount from the subframe by pulling it forward.

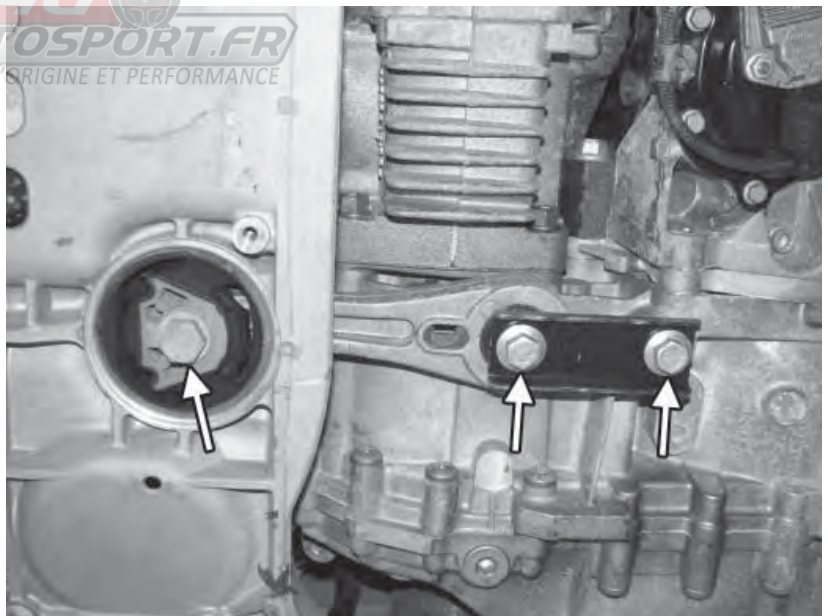

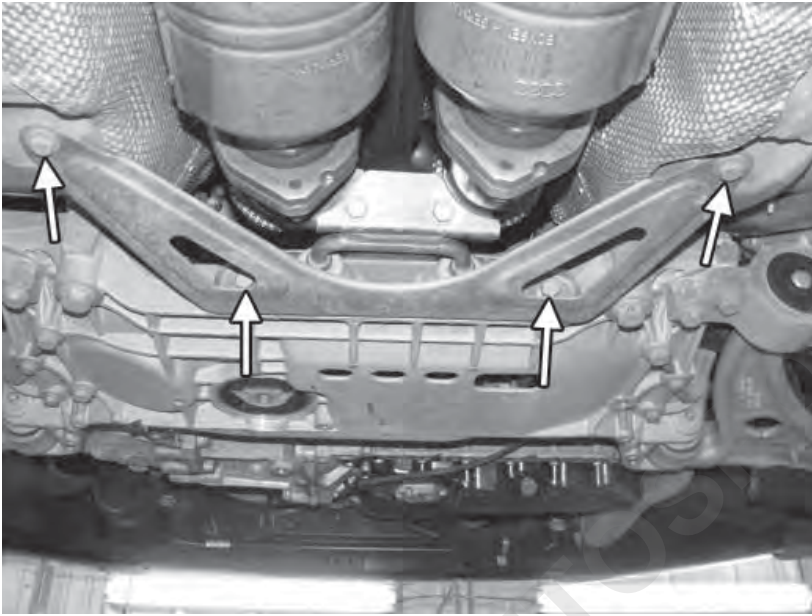

13) Remove the four 13mm bolts from the downpipe mounting bracket, and remove the bracket from the car.

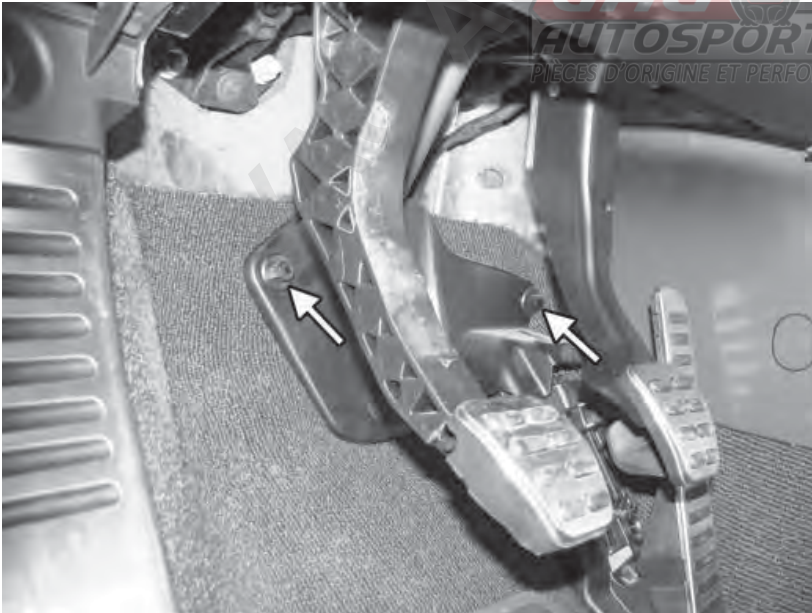

14) Remove the two 10mm bolts from the panel under the driver's footwell.

15) Turn the steering wheel straight forward, and remove the key from the car and lock the steering wheel in place. Remove the 13mm bolt connecting the steering linkage to the steering rack. Until this bolt is reinstalled, do NOT turn the steering wheel.

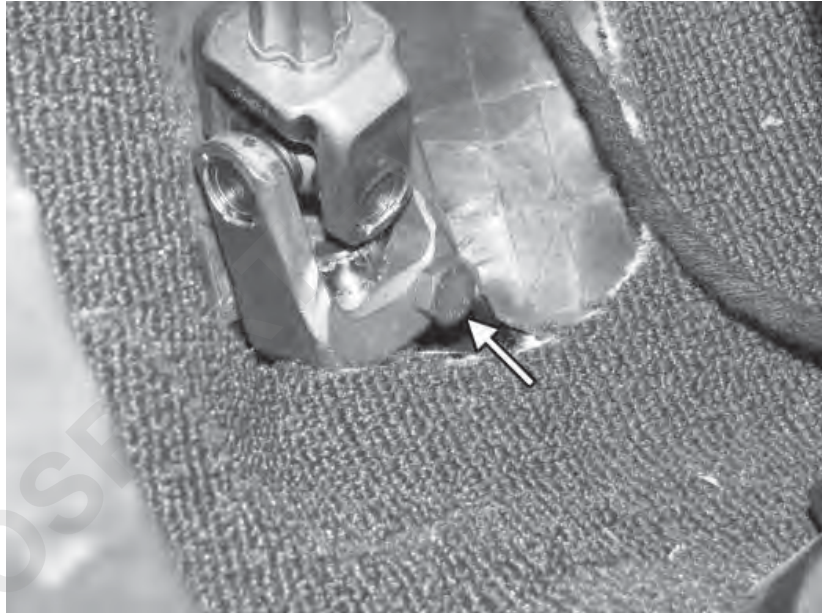

16) Support the front subframe with some sort of lifting device, such as a transmission jack. Remove the four 21mm bolts from the back of the subframe, and the two 18mm bolts from the front of the subframe.

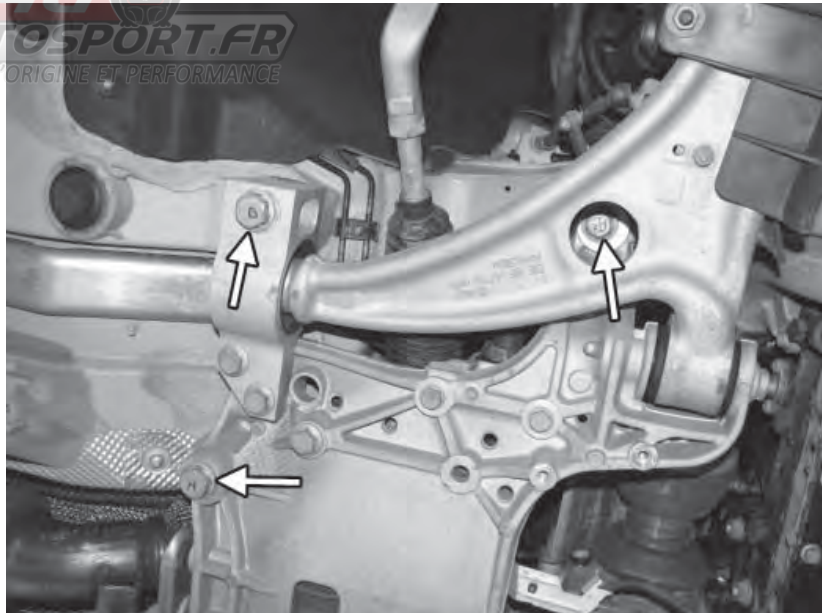

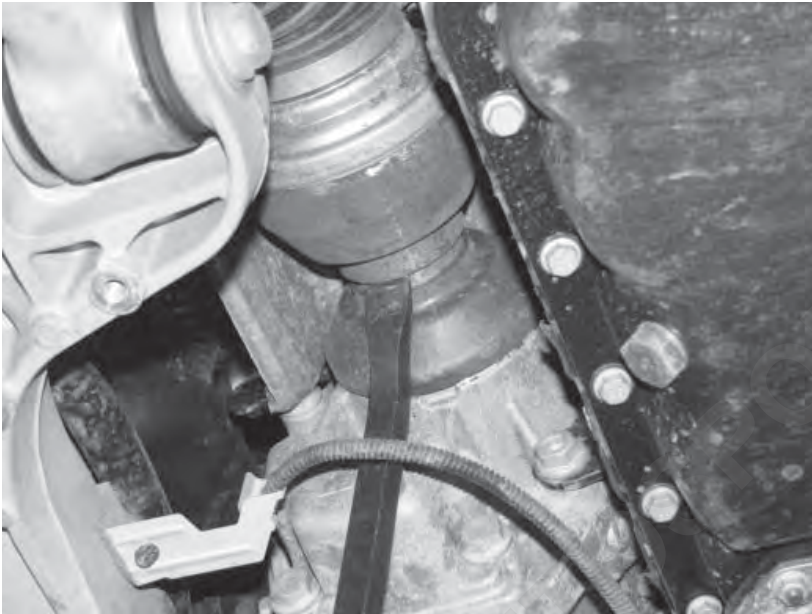

17) With a pry bar, carefully push the right side inner axle joint away from the front transfer case. With an assistant lifting the rotor/hub assembly from the lower control arm, remove the front right axle from the car.

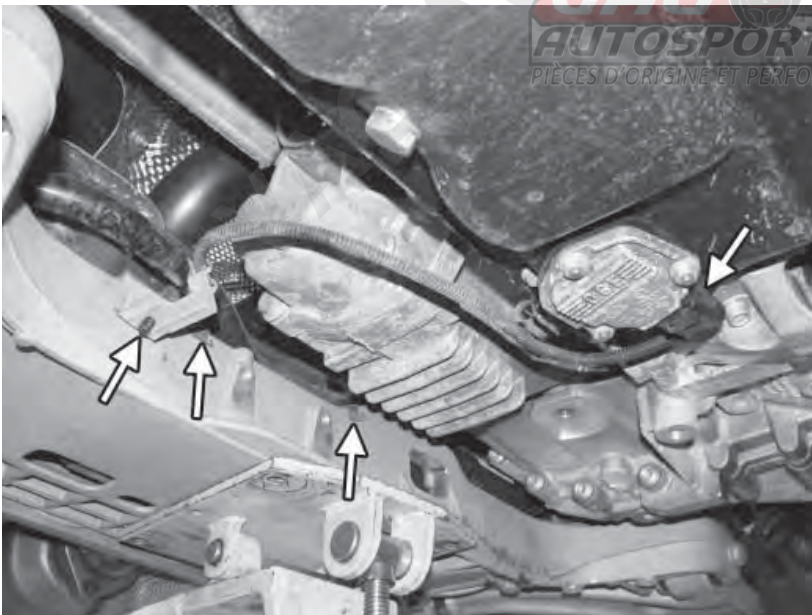

18) Unplug the oil level sensor, and remove the wiring harness from the clips.

19) With an assistant, pull the rotor/hub assemble away and lower the front subframe approximately three inches. Remove the one 10mm bolt holding the electromechanical steering wiring harness from the upper left portion of the subframe.



20) Lower the subframe a few more inches, and unclip the wiring harness. Also, carefully bend the steering rack heat shield up to access the clips and electrical connectors.

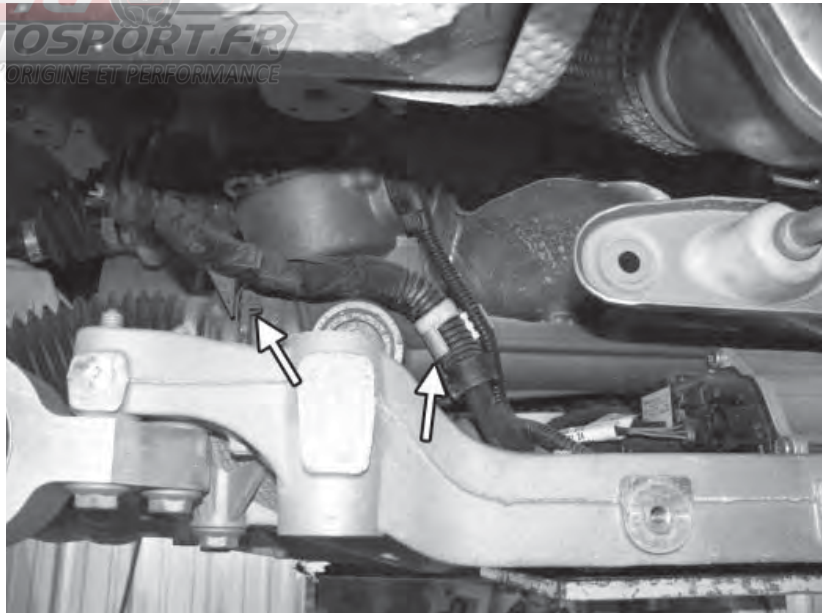

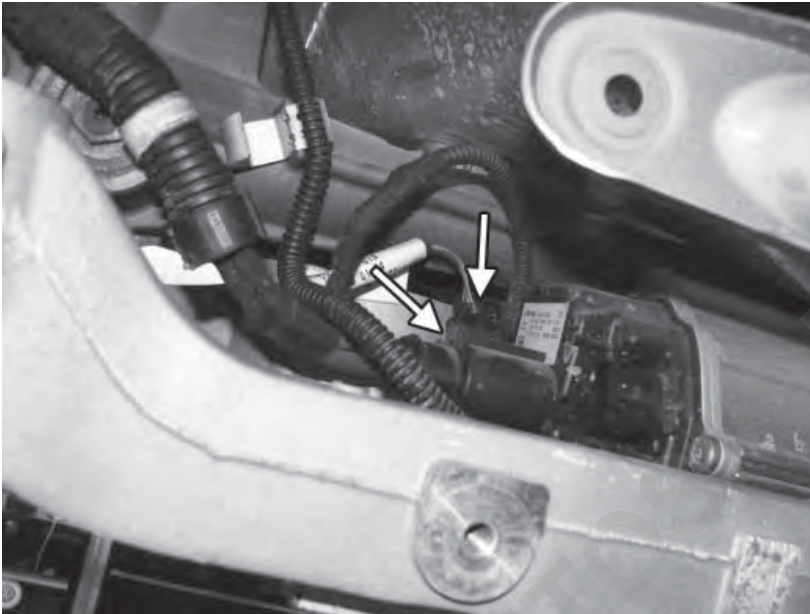

21) Disconnect the two steering rack electrical connectors. Carefully remove and separate the harness from the subframe. This harness also includes the oil level sensor that was previously disconnected. Lower and remove the subframe from the car and place in a safe location.

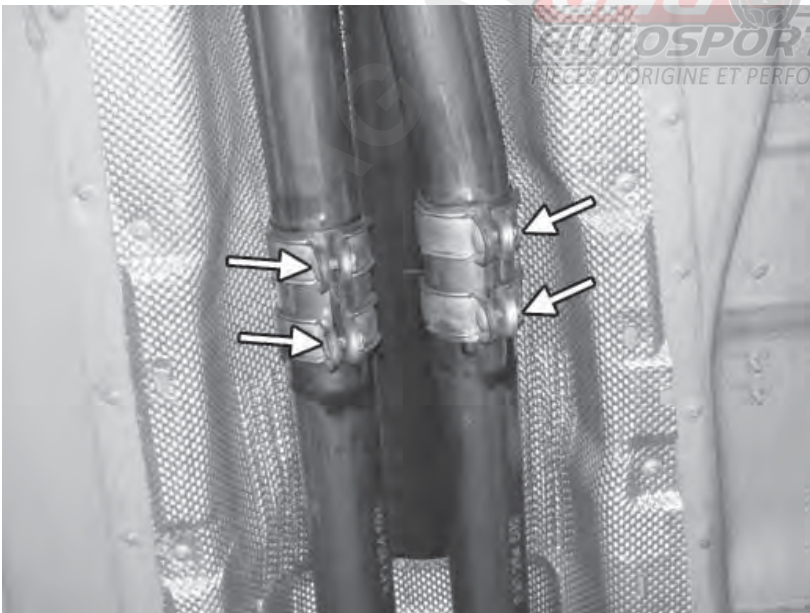

22) Remove the four 13mm bolts and loosen the exhaust clamps from the center of the car. Pull the clamps back, letting the downpipes hang.

23) With a pry bar, remove the two rubber exhaust hangers from the catback portion of the exhaust.

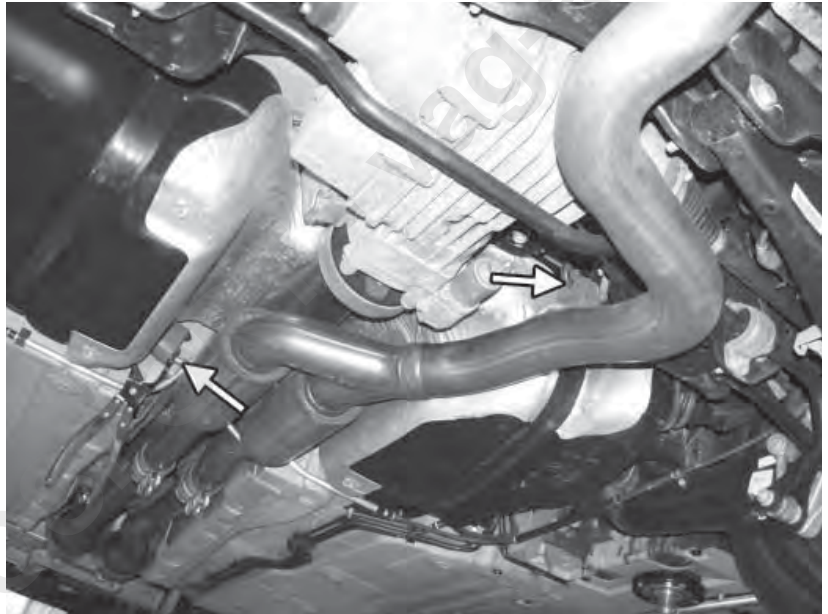

24) Remove the vacuum lines from the exhaust flap solenoids. With an assistant supporting the exhaust, remove the four 13mm bolts from the rear muffler and remove the catback portion of the exhaust from the car.

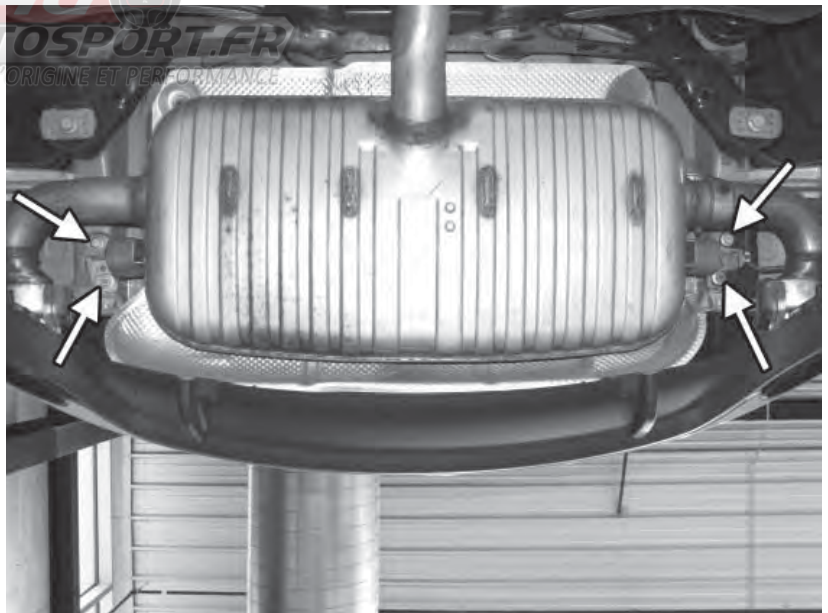

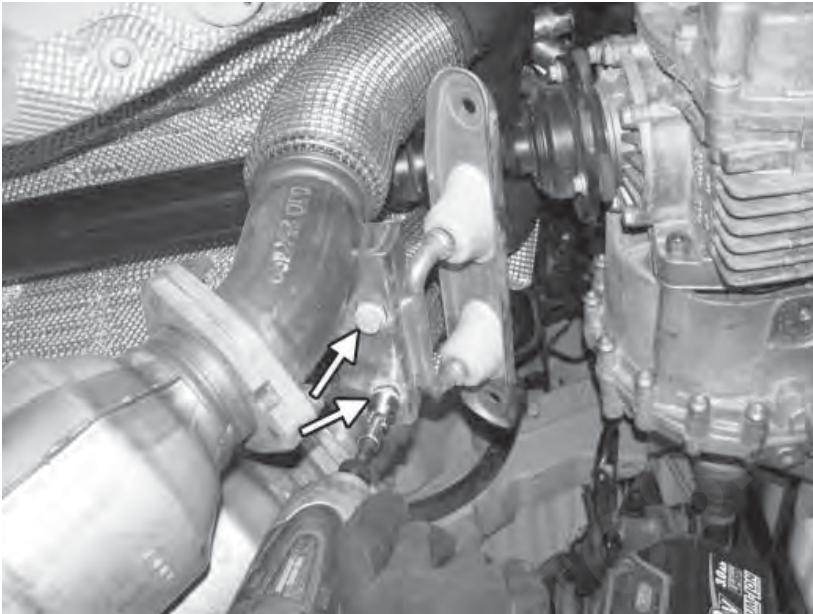

25) Remove the two 13mm bolts from the bracket that connects the front downpipes.

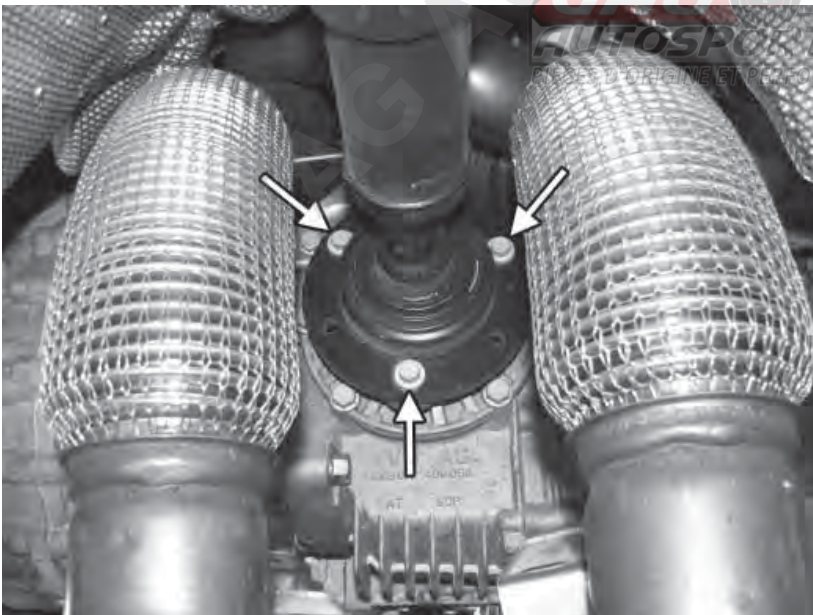

26) Remove the six 10mm 12-point bolts from both the front and the rear driveshaft flanges.

27) With an assistant, support the driveshaft. Carefully remove the two T30 Torx screws and two 13mm bolts from the center driveshaft bearing. Remove the driveshaft from the car.

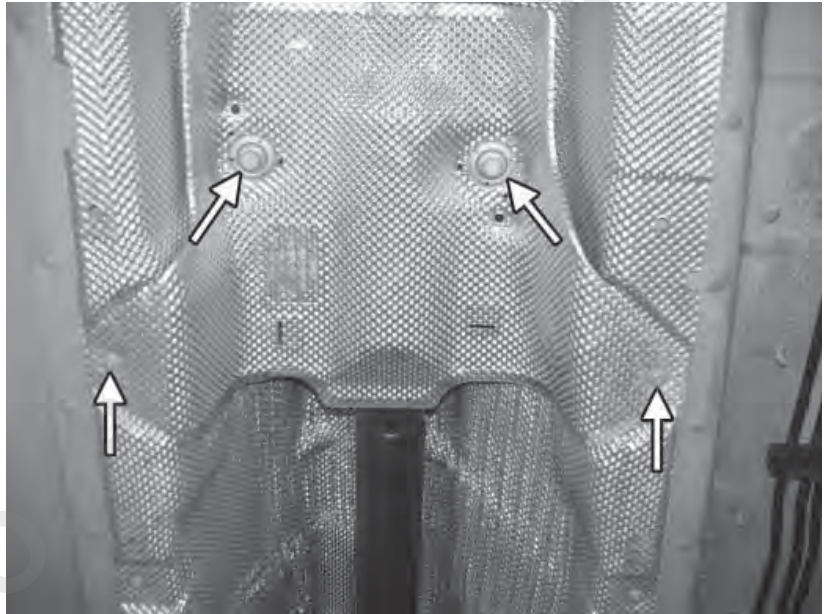

28) Remove the two 13mm bolts holding the downpipe to the transfer case bracket.

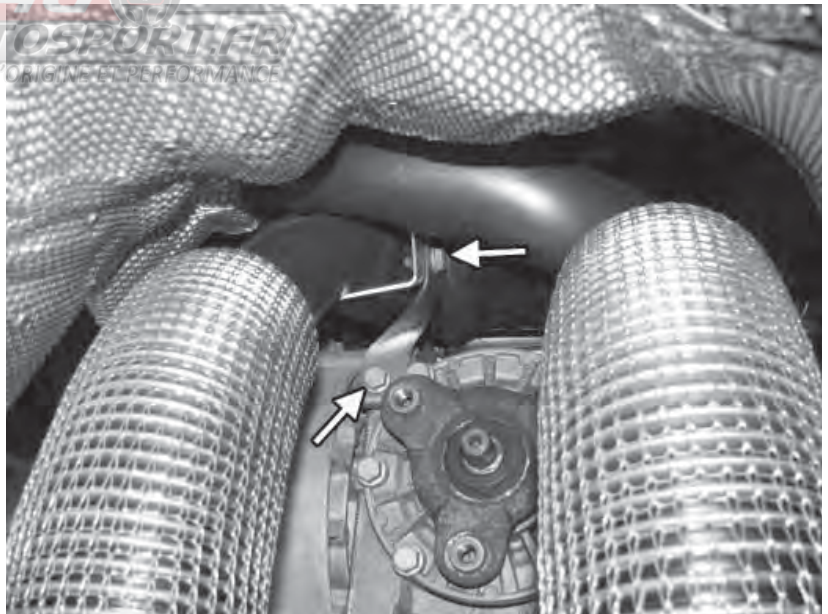

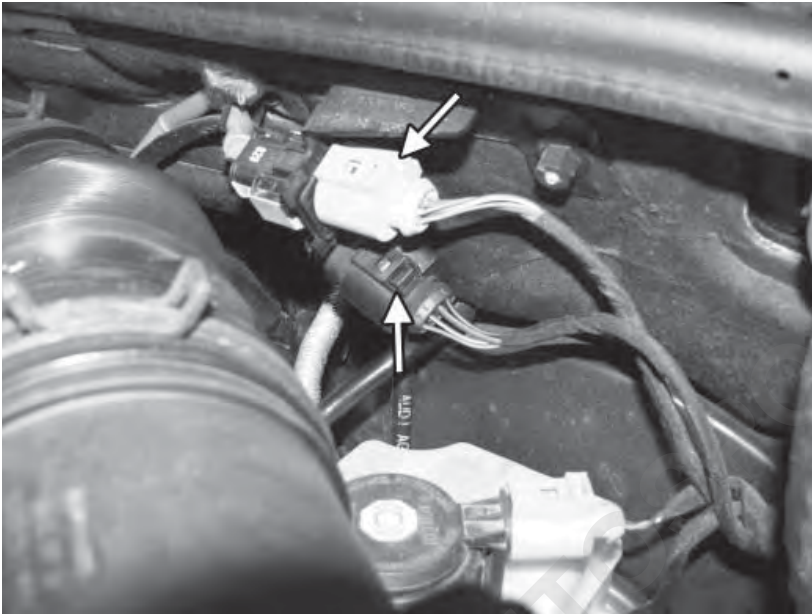

29) From the engine firewall of the car, disconnect the two oxygen sensor connectors. After cutting the zip ties to separate them, route the secondary oxygen sensor harness down underneath the car for removal with the downpipe.

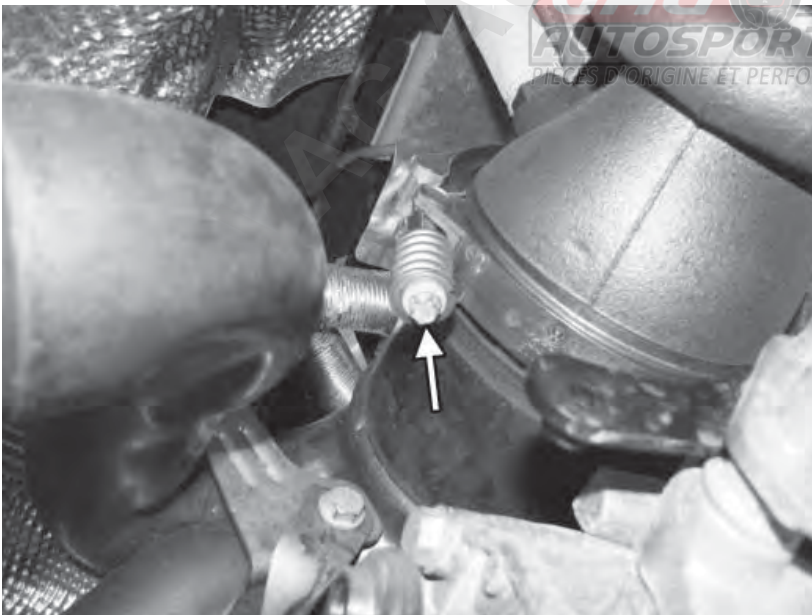

30) Remove the 10mm external Torx fastener from the stock V-band clamp connecting the turbocharger to the downpipe.

31) With an assistant holding the downpipes, use a prybar to ease the V-band clamp off the turbocharger. Lower and remove the downpipes with the secondary oxygen sensor from the car. If equipped, remove the EGT sensor from the turbo manifold.

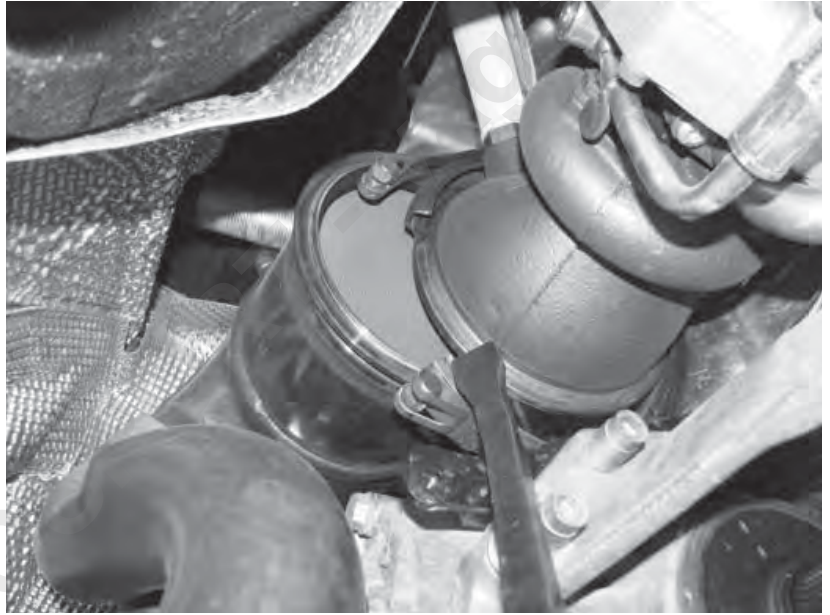

32) Remove the three 8mm allen bolts from the axle heat shield and remove from the car.

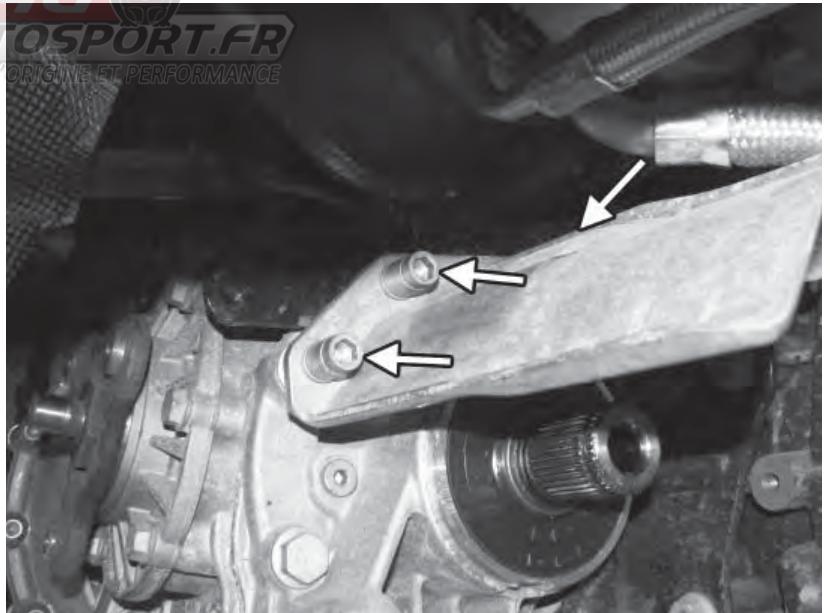

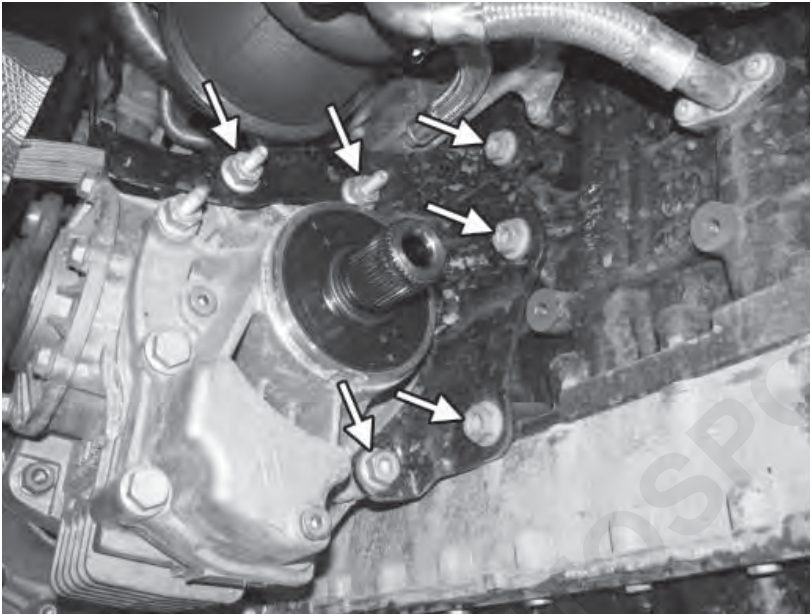

33) Remove the six 16mm bolts and nuts holding the transfer case bracket to the engine block, and remove the bracket.

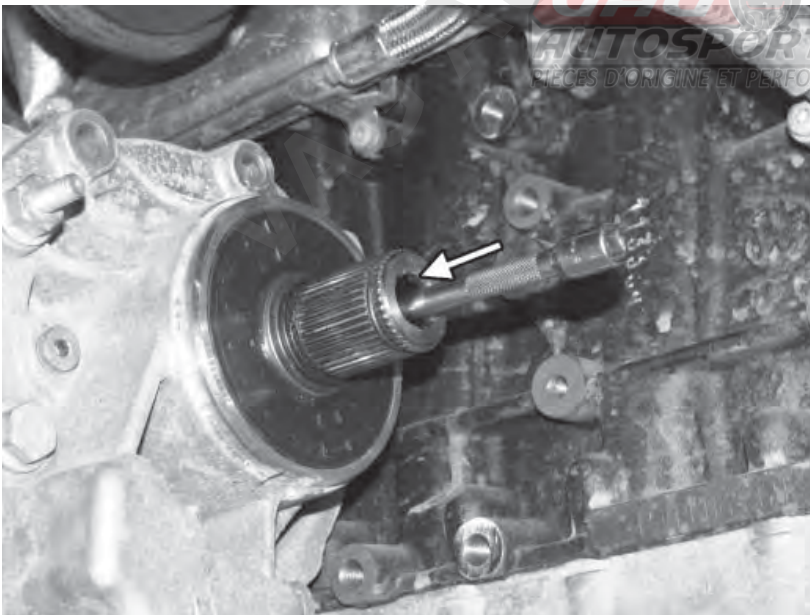

34) Using a long 1/4" extension, remove the 6mm allen bolt that is located inside the right axle stub.

35) Remove the two lower 16mm bolts (shown) and the two upper 16mm bolts (not shown, on opposite/top side of transfer case) that hold the transfer case to the transmission.

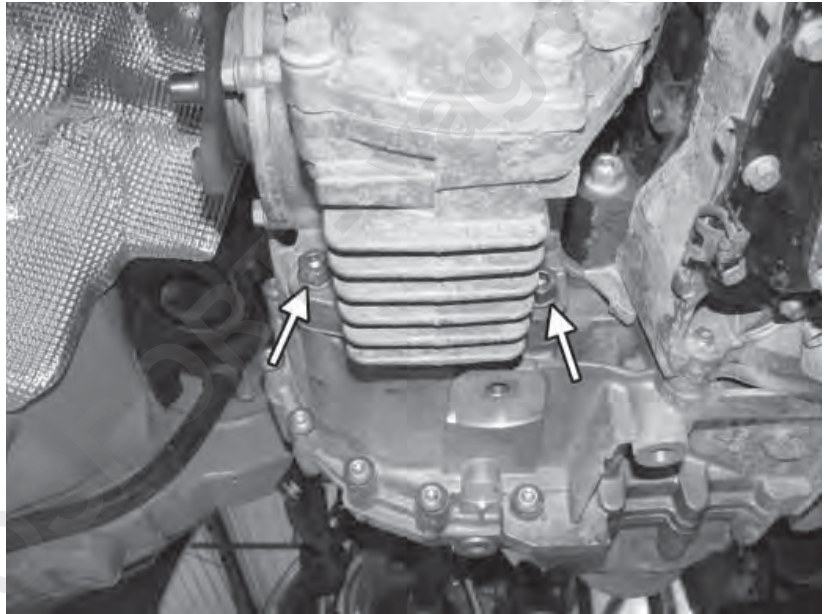

36) Carefully pry and pull the transfer case away from the transmission and remove from the car.

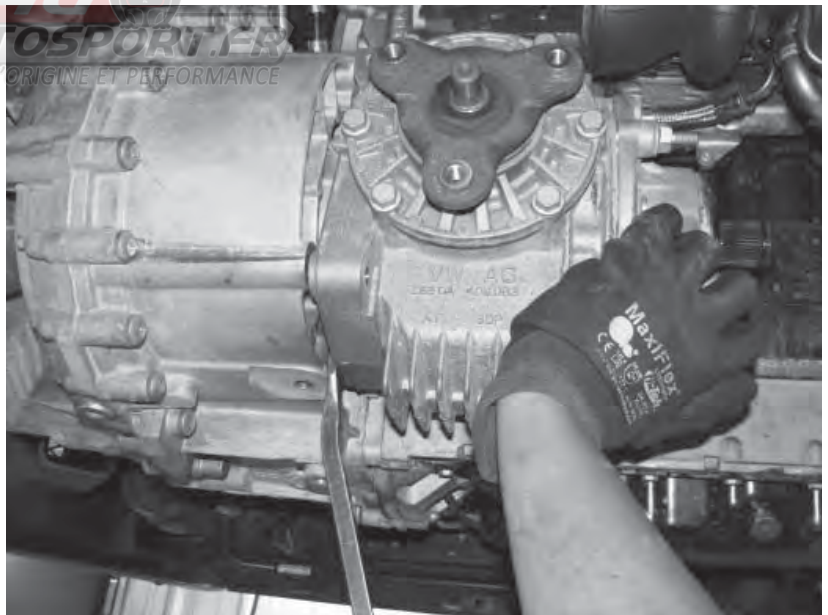

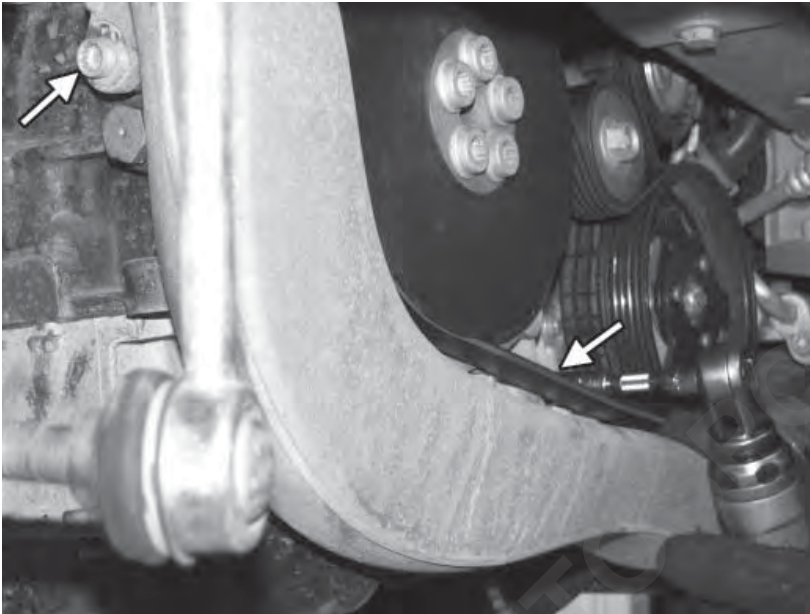

37) Remove the one 10mm triple square bolt and one 10mm nut and washer from the stock pancake pipe.

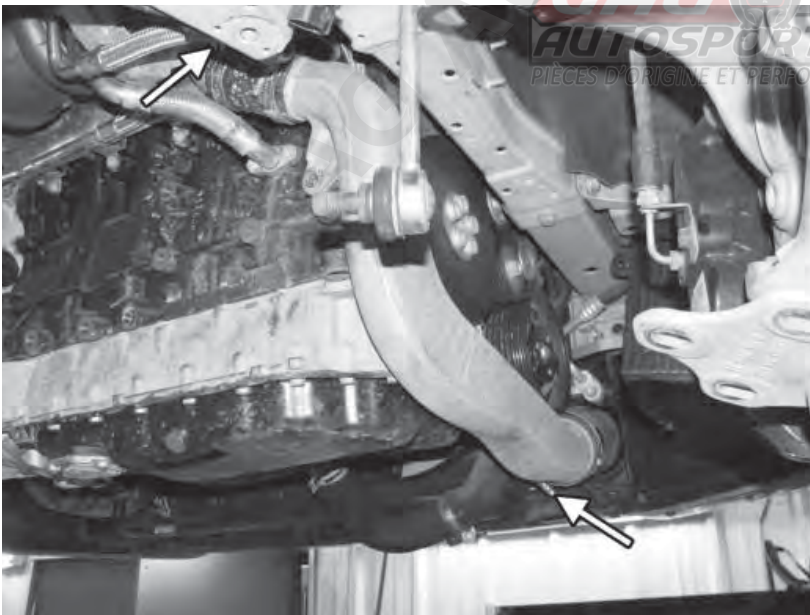

38) Loosen the 7mm hose clamps from the pancake pipe and remove the pancake pipe and the rubber hose connecting it to the turbocharger.

39) Drain the engine oil by removing the 19mm drain plug. Properly dispose of the old oil and reinstall the drain plug when finished. Torque the drain bolt to 19lb-ft.

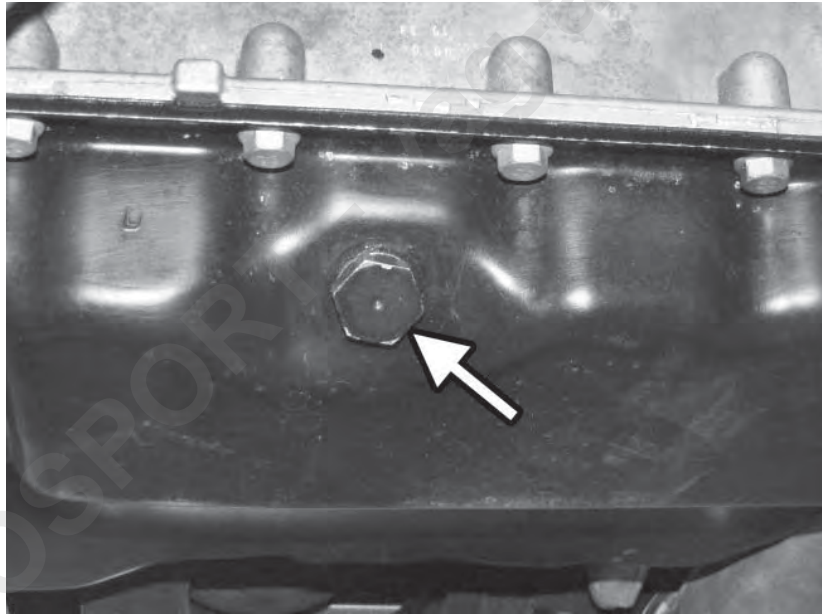

40) Drain the engine coolant. The easiest way is to remove the spring clamp from the lower radiator hose where it connects at the front of the engine. Be sure to loosen the coolant expansion tank cap to allow all the coolant to drain. Reinstall the coolant hose.

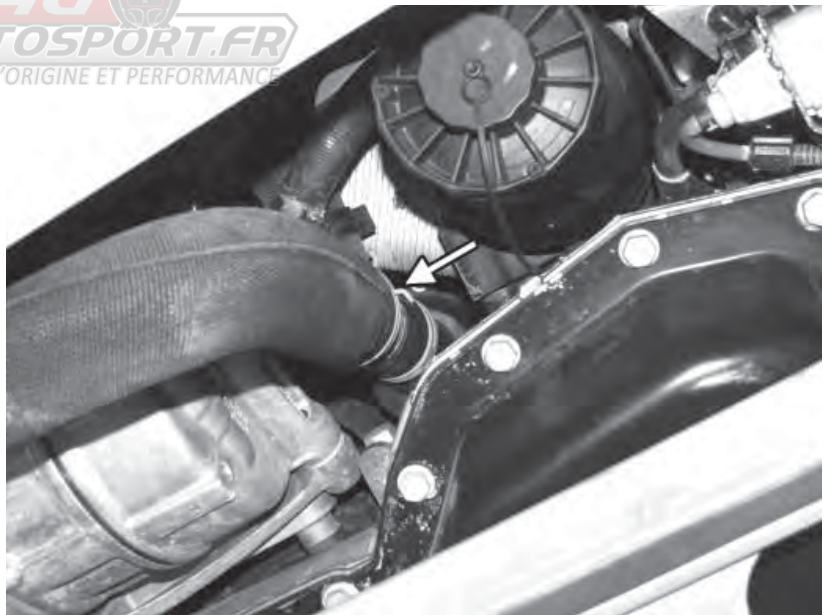

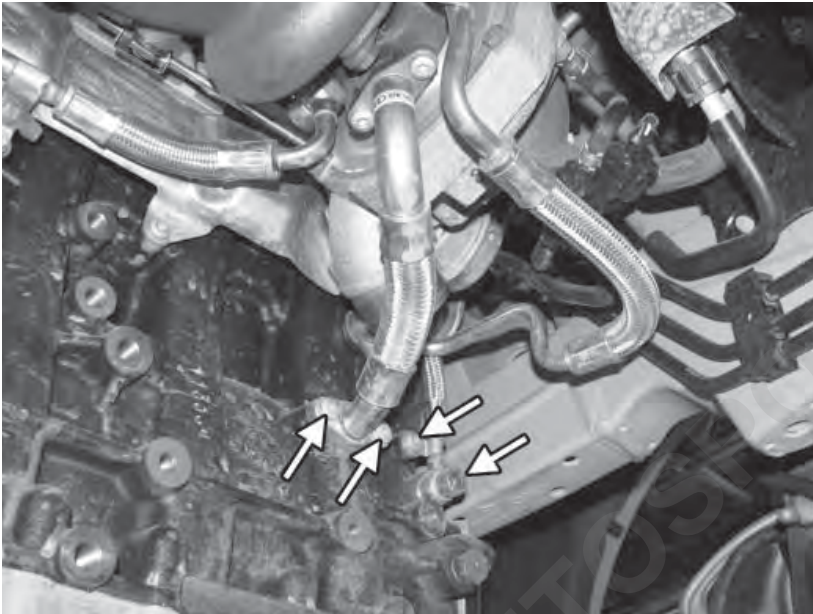

41) Remove the two T30 Torx screws from the oil drain line, and remove the line from the engine block. Also remove the one T30 Torx screw from the oil feed line, and then remove the 8mm allen banjo bolt and remove the oil feed line.

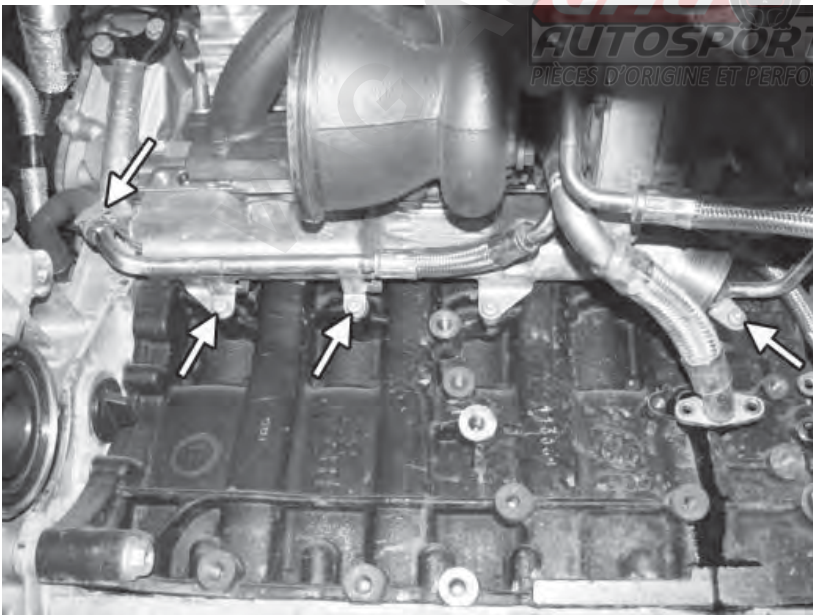

42) Remove the one T30 Torx screw from the coolant drain line. Remove the two T30 Torx screws from the coolant feed line. After removing the spring clamp where the red rubber coolant feed hose connects to the coolant feed line, disconnect the coolant feed line. The spring clamp from the red line will be reused later. Reinstall the one T30 Torx screw that holds the heat shield over the knock sensors.

43) Remove the airbox inlet lid by unclipping the two tabs on the cover.



44) Remove the airbox inlet coupler by unclipping the four tabs that connect the airbox to the radiator core support.

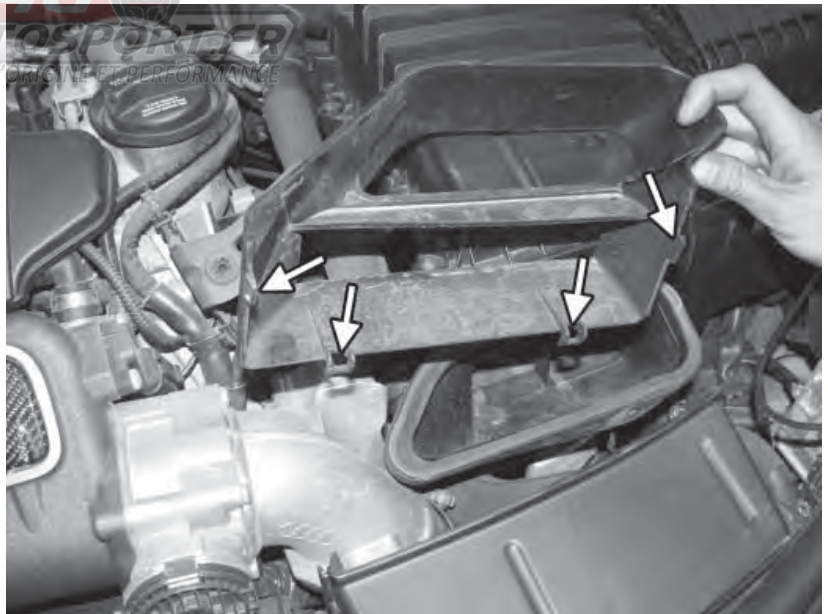

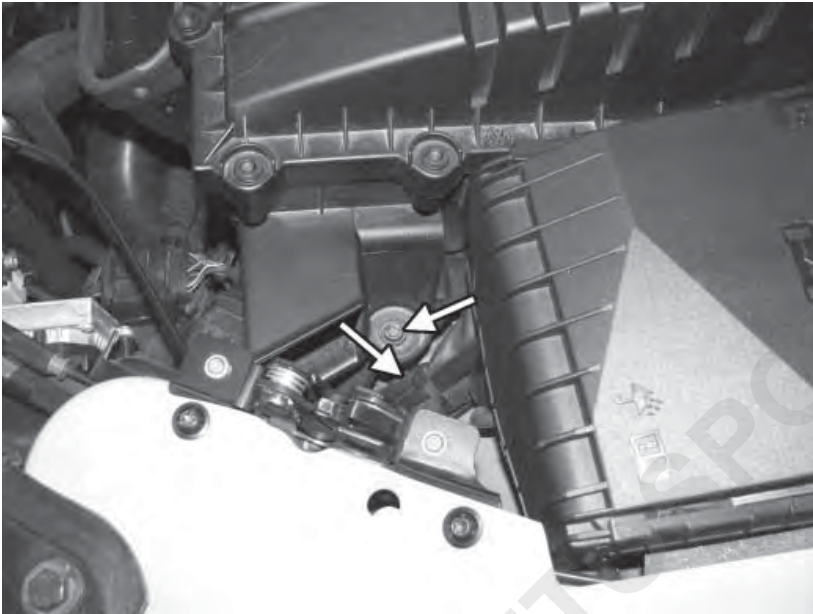

45) Remove the 5mm allen screw from the side of the stock airbox. Also remove the 10mm bolt just to the left and down from the 5mm allen screw.

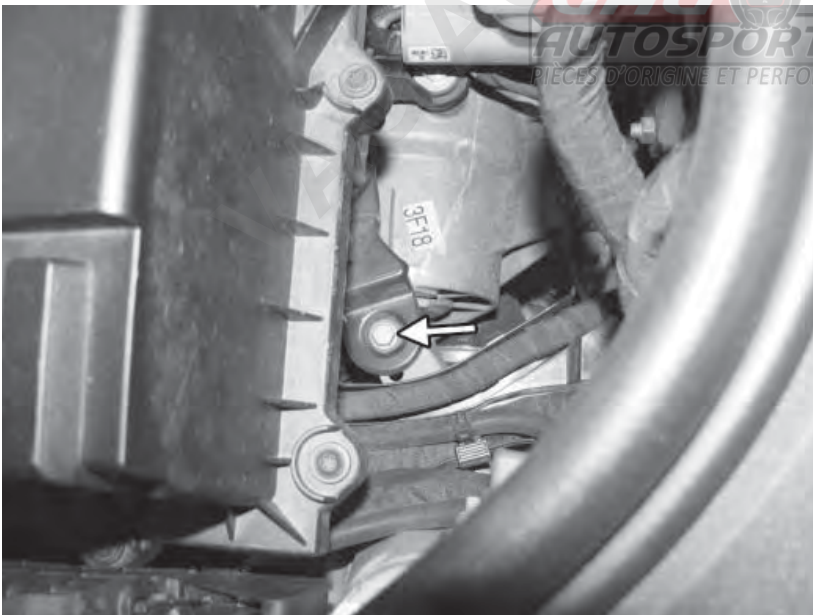

46) Remove the 10mm bolt from the back of the stock airbox

47) Remove the spring clip from the recirculation valve hose and remove the hose from the air intake.



48) Remove the two T30 Torx screws that connects the stock inlet pipe to the back of the engine. Also remove the spring clamp that connects the inlet pipe to the stock compressor inlet pipe.

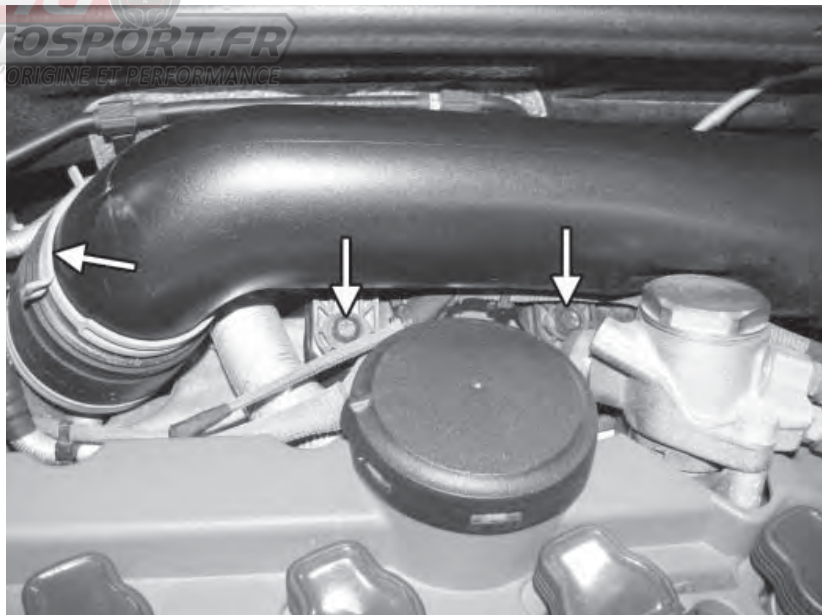

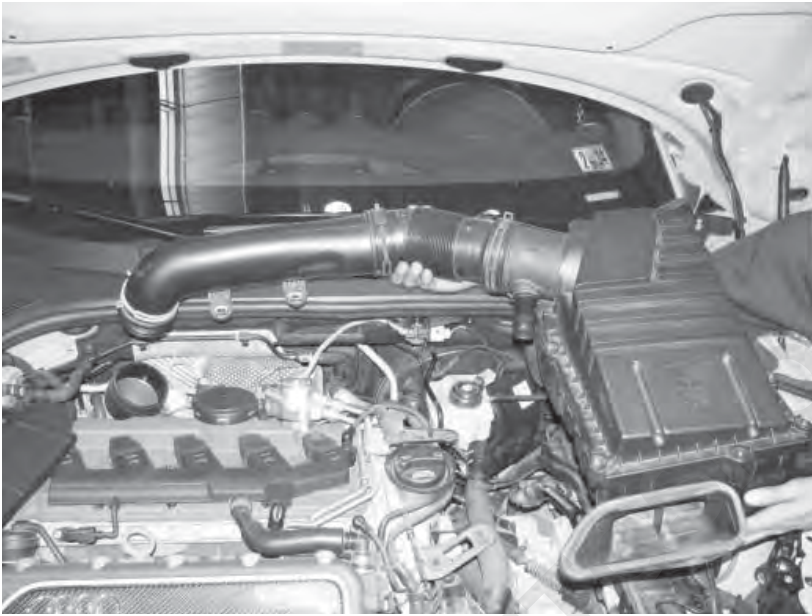

49) Remove the entire airbox and intake assembly. The airbox will come out of the car with the mounting bracket that holds it in place.



50) Disconnect the primary oxygen sensor electrical connector at the firewall. Using an oxygen sensor socket, loosen and remove the primary oxygen sensor and its wiring connector from the car.

51) Unplug the electrical connector from the pressure sensor on the back side of the high pressure fuel pump.

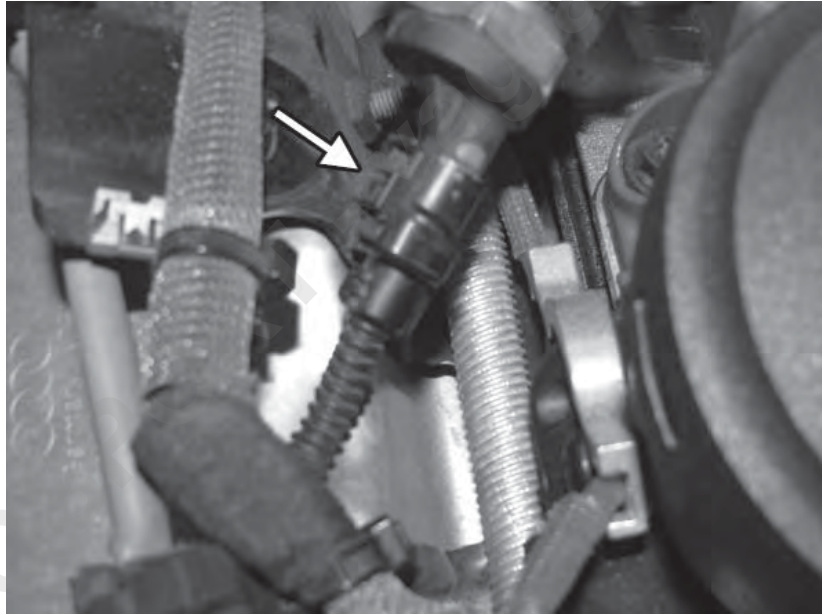

52) On the metal accordion PCV hose that connects to the compressor inlet pipe, remove the two T25 Torx screws from the back of the cylinder head. The metal plate holding the hose in also disconnects with these screws.

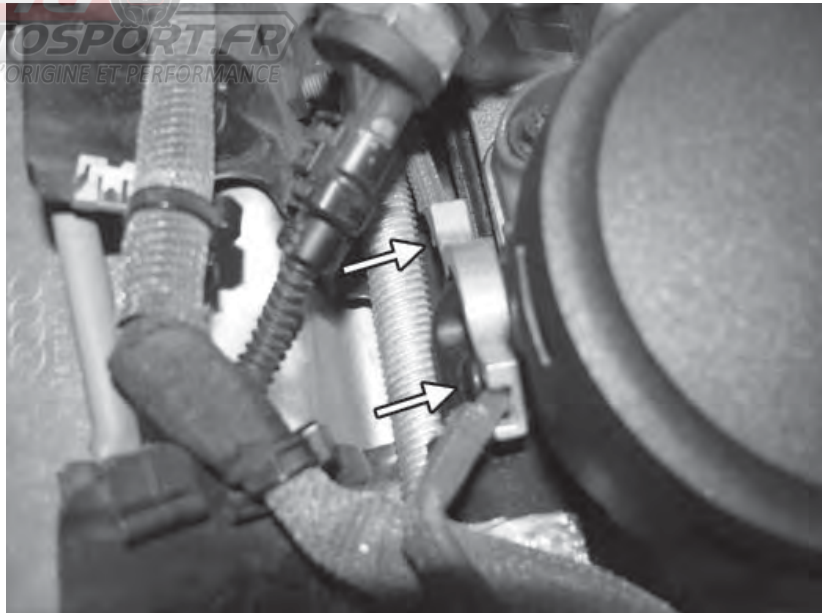

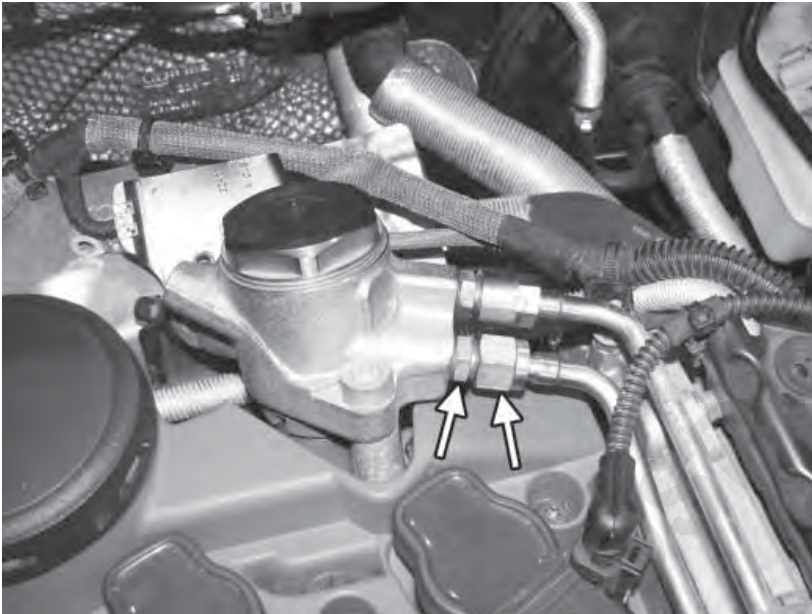

53) Loosen the lower nut on the high pressure fuel pump by holding the brass fitting in the pump with a 14mm wrench, and using a 17mm wrench to remove the nut. A rag can be used to prevent excess fuel spillage.



54) Loosen the upper nut on the high pressure fuel pump by holding the brass fitting in the pump with a 14mm wrench, and using a 15mm wrench to remove the nut.

55) In order to remove the lines from the pump, the two T30 screws on the fuel lines must be loosened. First, remove the top T30 screw. In order to access the bottom T30 screw, you will need to carefully push the upper line towards the right side of the car. Once both are removed, the fuel lines can be pushed slightly towards to left side of the car to disconnect them from the pump.

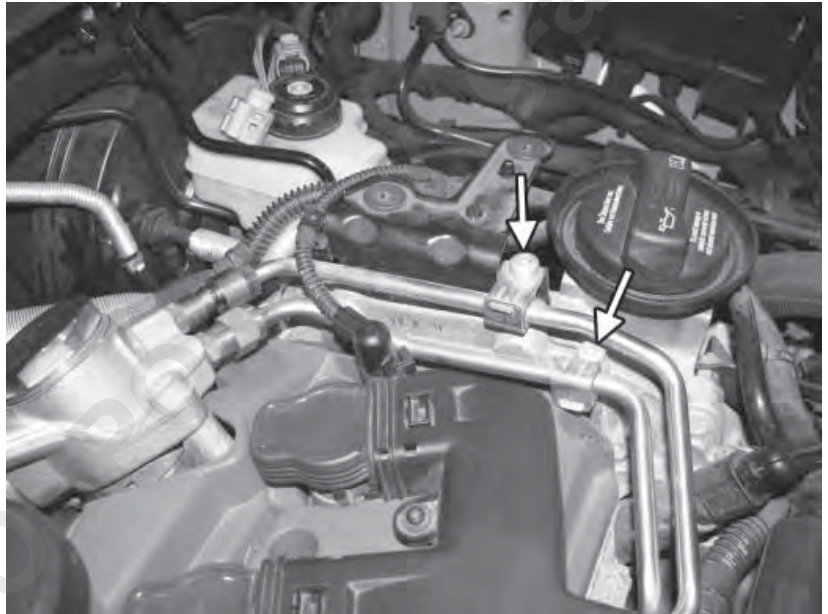

56) Remove the two 10mm triple square bolts from the fuel pump and lift up on the pump to remove it from the car.

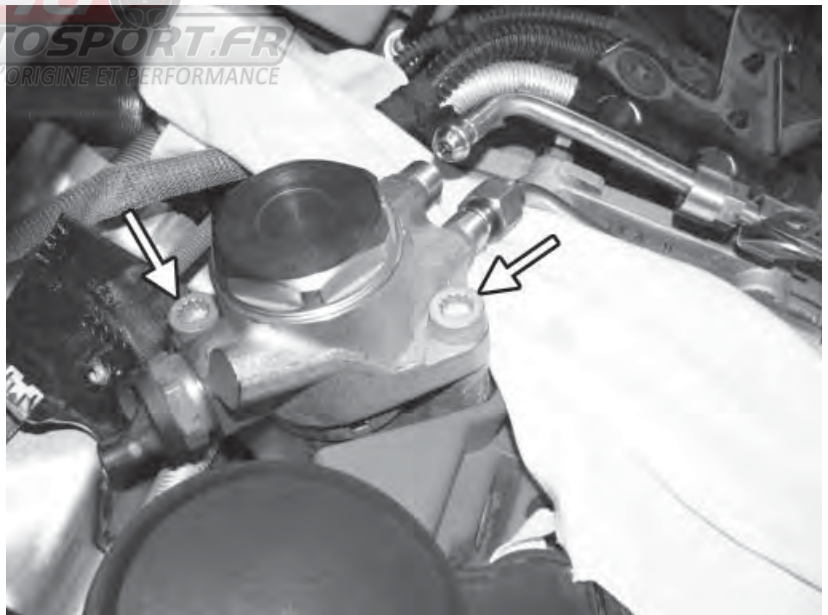

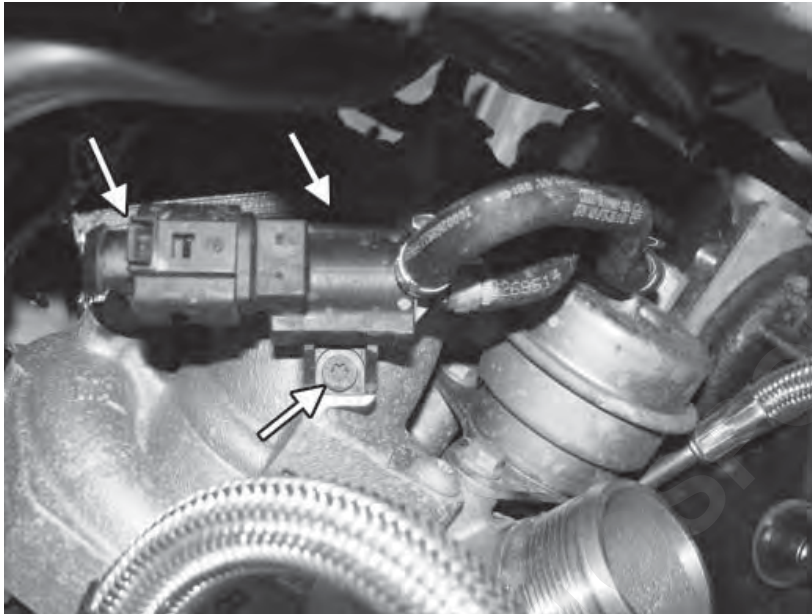

57) Disconnect the electrical connector from the N75 valve, and remove the two T25 Torx screws from the valve.

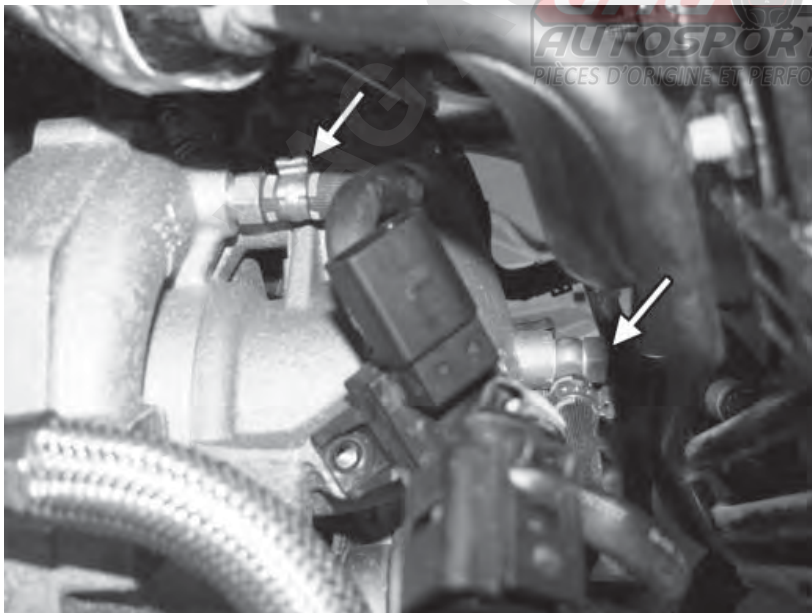

58) Remove the crimp clamp and N75 vacuum line that connects to the compressor outlet on the left. Also unbolt the 13mm banjo bolt on the N75 vacuum line that is connected to the compressor inlet.

59) Remove the crimp clamp and N75 vacuum line that connects to the turbocharger wastegate, and remove the N75 valve from the car.

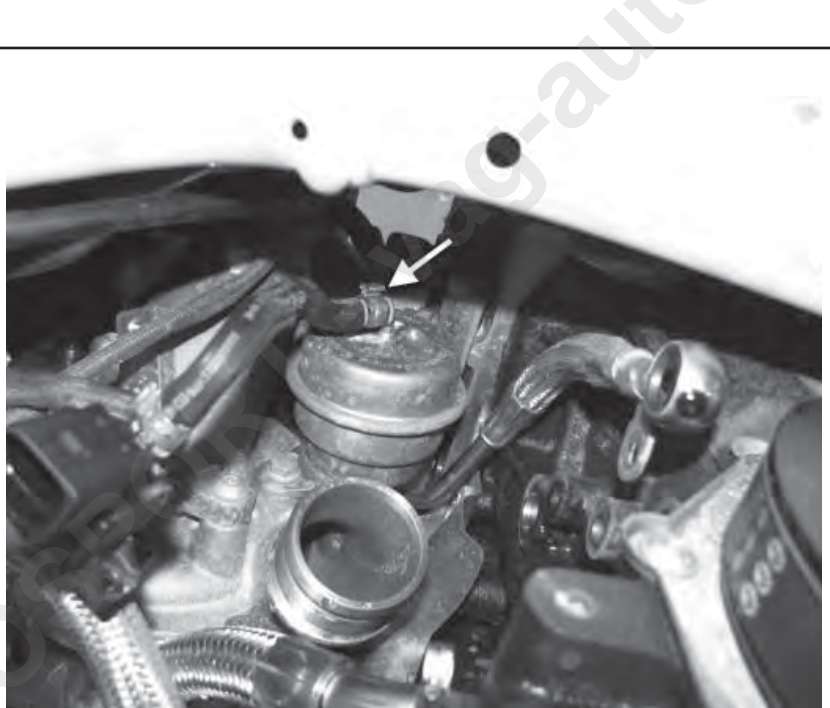

60) Remove the two T30 Torx screws that connect the compressor inlet pipe to the turbocharger.

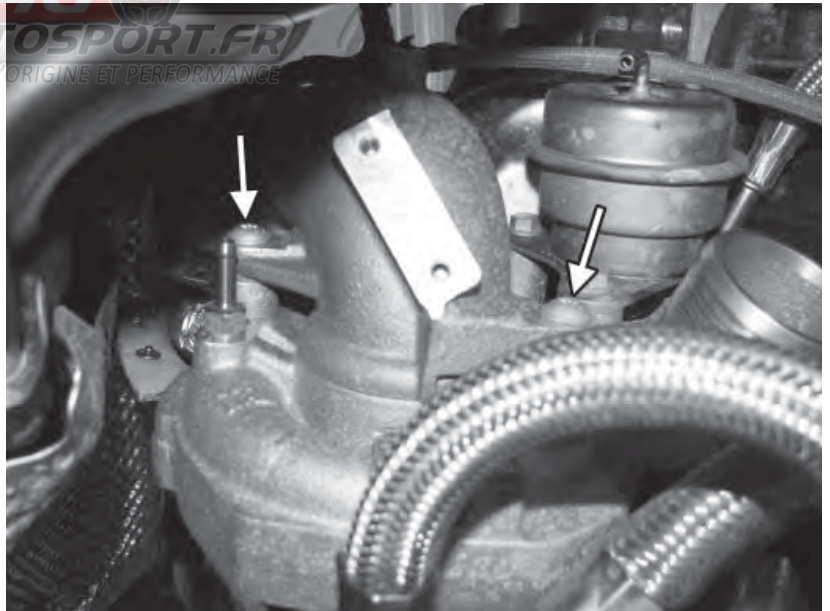

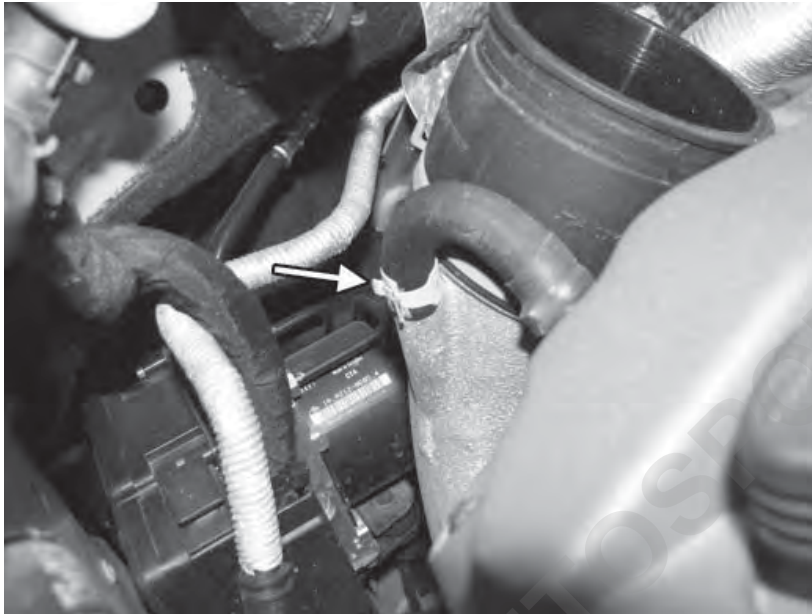

61) Remove the spring clamp and vacuum line from the vacuum hose on the top side of the compressor inlet pipe.

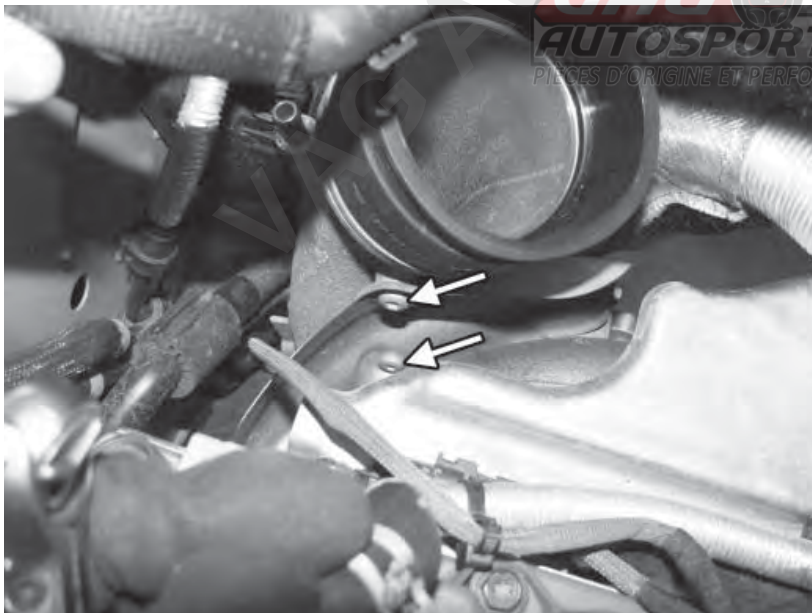

62) Remove the two T30 Torx screws that connect the compressor inlet heat shield to the compressor inlet. Remove the heat shield and then the compressor inlet pipe from the top of the car.

63) Remove the six 11mm copper nuts on the top side of the exhaust manifold. Once removed, remove the two metal "bridges/spacers" that each connect three of the upper manifold studs together.

WARNING: Do NOT loosen or remove the nuts on the bottom v-block spacers that the exhaust manifold sits on!!

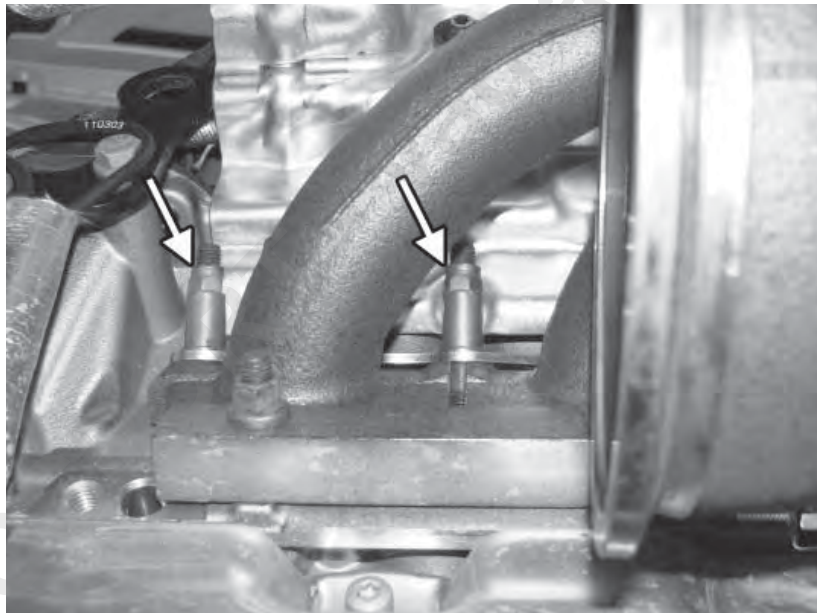

64) Remove the four T30 Torx screws and one 6mm allen bolt from the factory heat shield (as shown off the car), and remove the heat shield from the car.

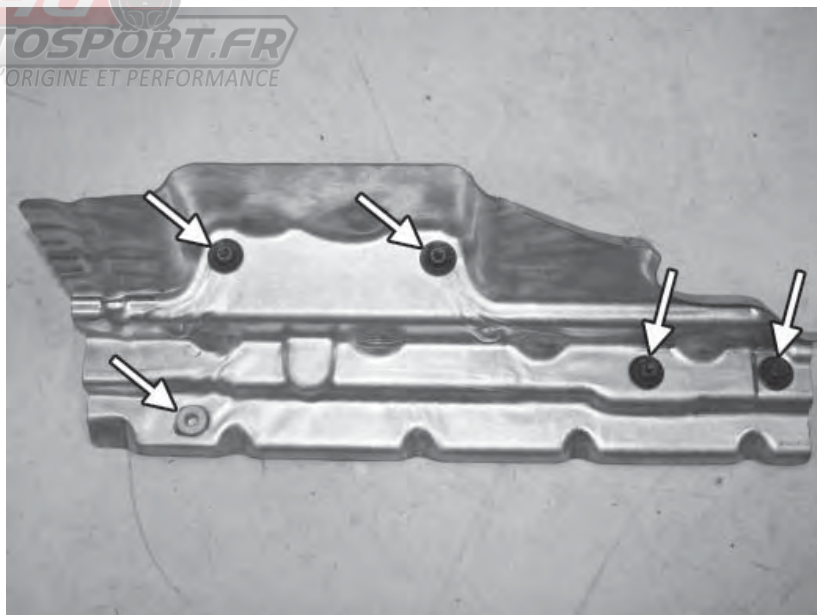

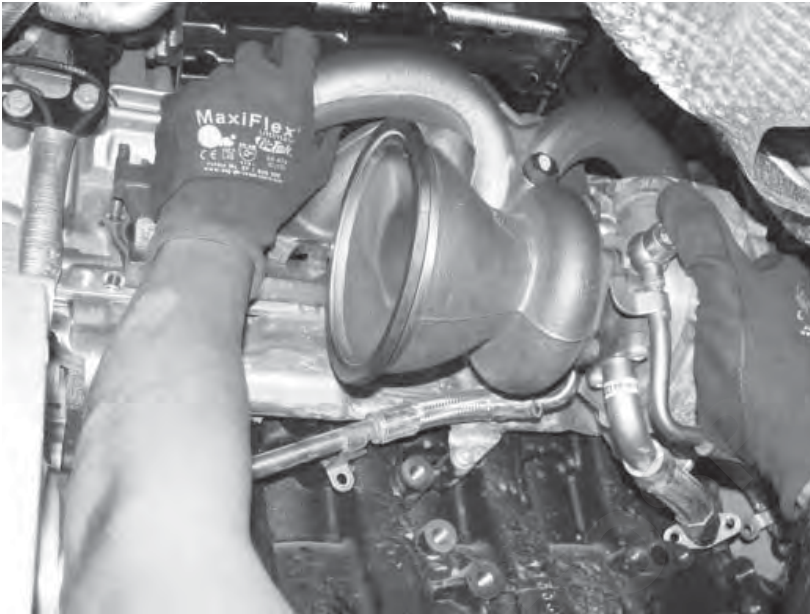

65) Lift the factory turbocharger/exhaust manifold assembly and then rotate the top side of the manifold flange away from the cylinder head. Again, do NOT loosen the lower spacers on the bottom side of the manifold. Carefully remove the assembly from the car.

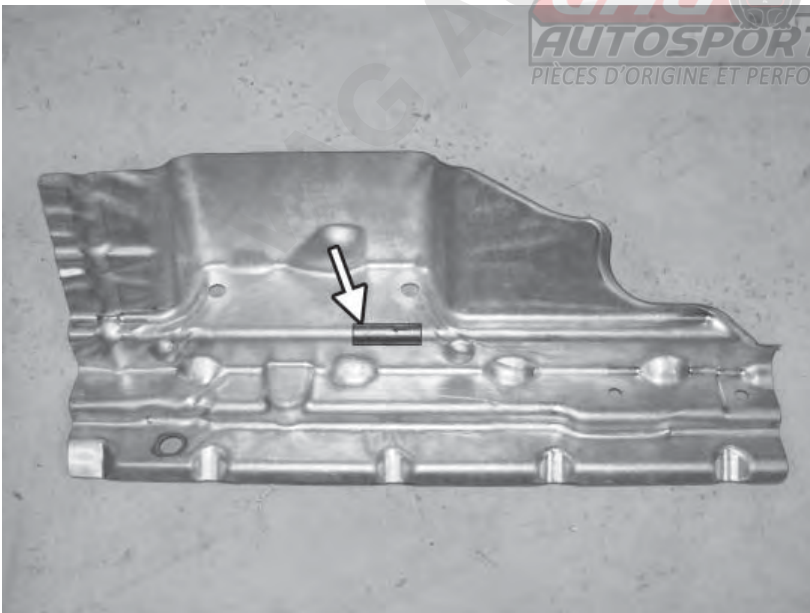

66) Take the factory heat shield and carefully clearance the highlighted area with a small hammer so that the APR manifold does not come in contact with the heat shield when installed. Take care to not put a hole in the heat shield.

67) Remove the old exhaust manifold gasket from the car and install the new supplied one. Reinstall the factory heat shield using the four T30 screws and the one 6mm allen screw.

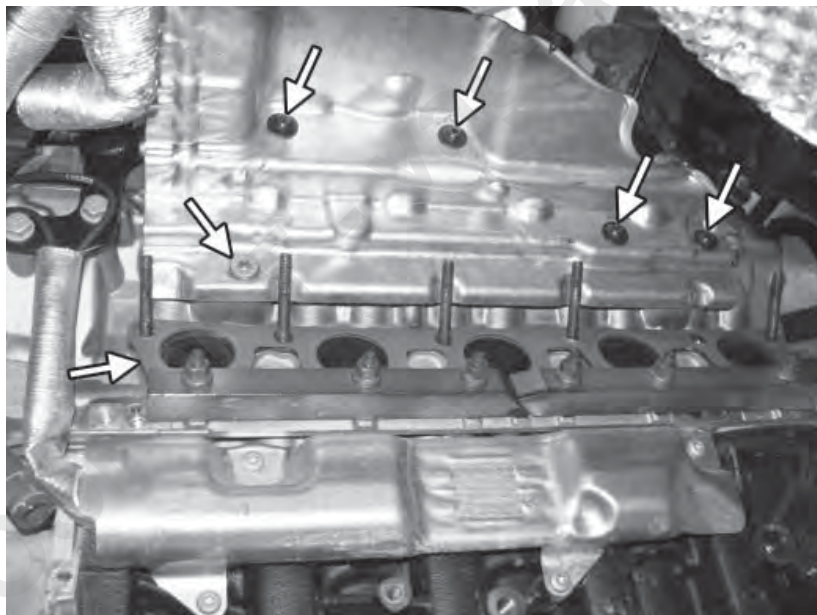

68) Install the wastegate onto the manifold with the supplied V-band clamp. Tighten the clamp with the supplied wrench and 8mm nut so the wastegate can still be rotated by hand, but will not spin on its own. If not equipped with an EGT sensor, install the supplied 17mm plug in the exhaust manifold.

WARNING: Do NOT loosen the manifold to turbocharger V-band clamp. This comes preset from APR.

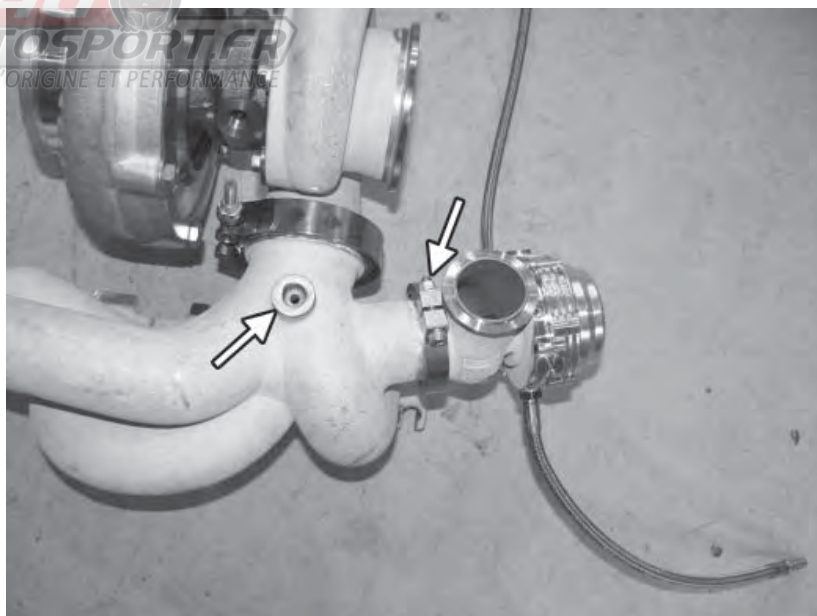

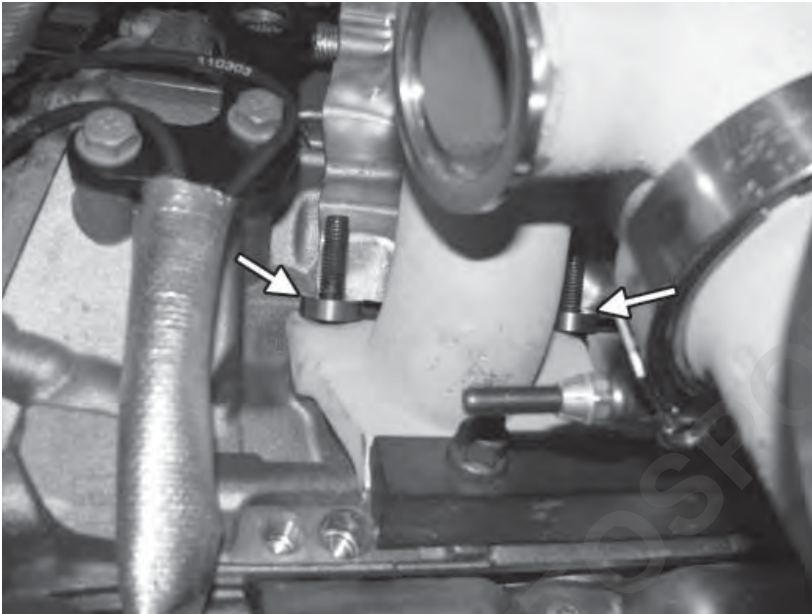

69) Place the APR manifold/turbo assembly in the car by resting the bottom of the manifold flange in the stock resting blocks and then pivot the top of the flange towards the cylinder head. Make sure the heat shield clears the manifold runner. If necessary, remove the manifold and heat shield to clearance the heat shield more. Once the heat shield is sufficiently cleared and the heat shield and manifold are installed, install the six supplied manifold spacers/washers.

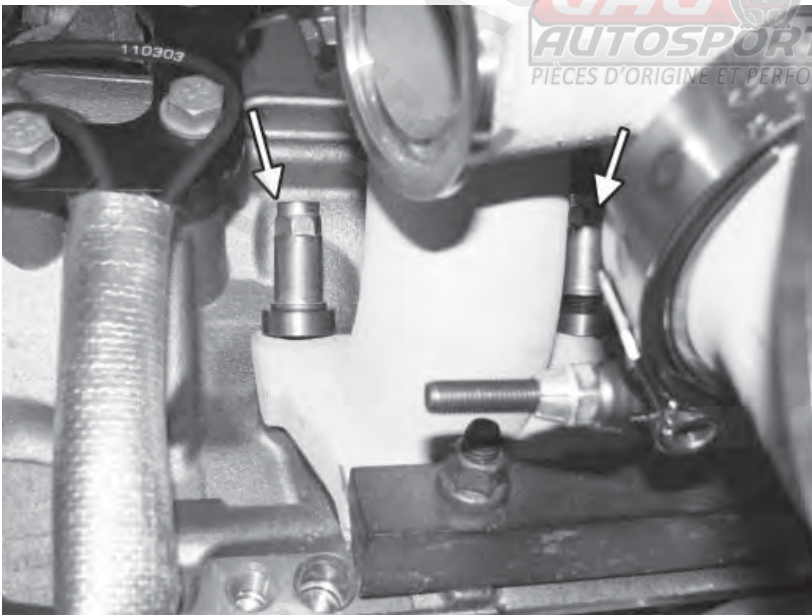

70) Install the six new, supplied 11mm exhaust nuts to hold the manifold in place and tighten from the center nuts working towards the outside ones, torquing them to 25lb-ft. Ensure that the APR manifold is sitting flush against the cylinder head and is not in a bind.

71) On the APR turbo, install and tighten the supplied 16mm brass oil feed line adapter and tighten in place.

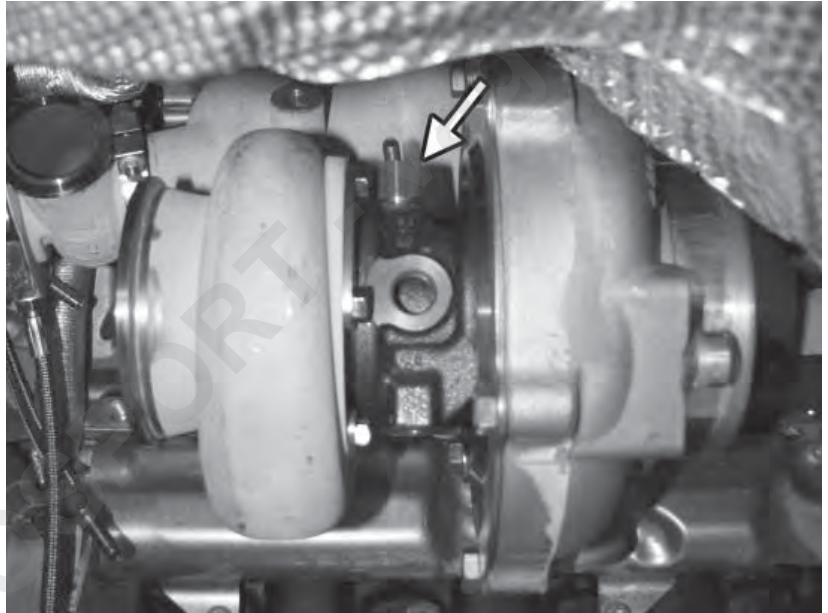

72) Install the oil feed line into the brass fitting that was just installed in the top of the turbocharger. Before fully tightening the line in place, orient the line towards the right side of the turbocharger, and at about a 10° angle towards the front of the car. Tighten the fitting by holding the brass fitting with a 16mm wrench and then tighten the 11mm line.

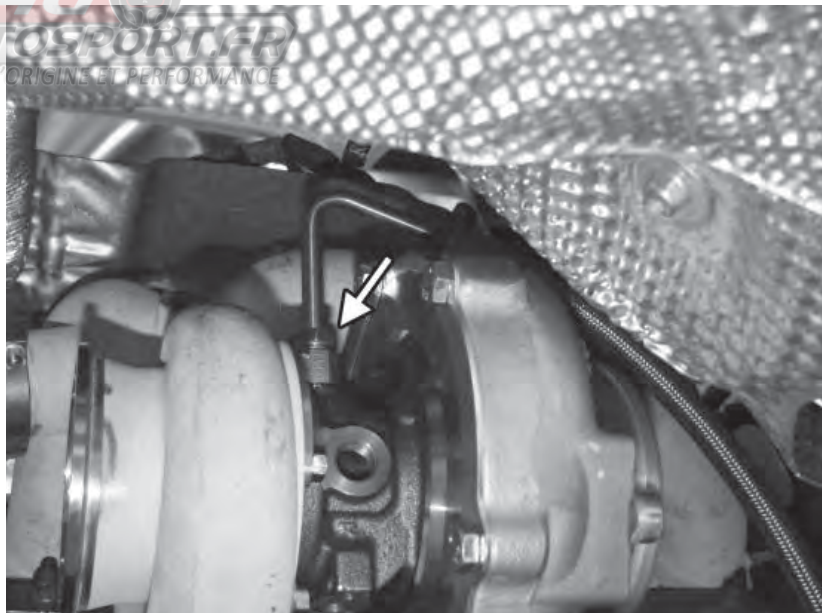

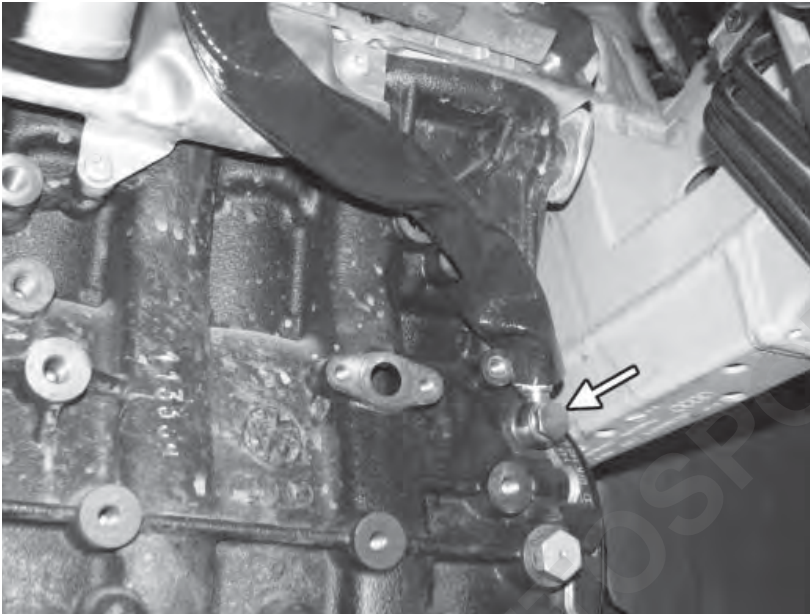

73) Install the supplied heat sheathing over the oil feed line, and then install the banjo bolt to the same location as the stock line. Be sure to use the supplied crush washers on both sides of the banjo fitting, and then tighten the 16mm banjo bolt to 38Nm.

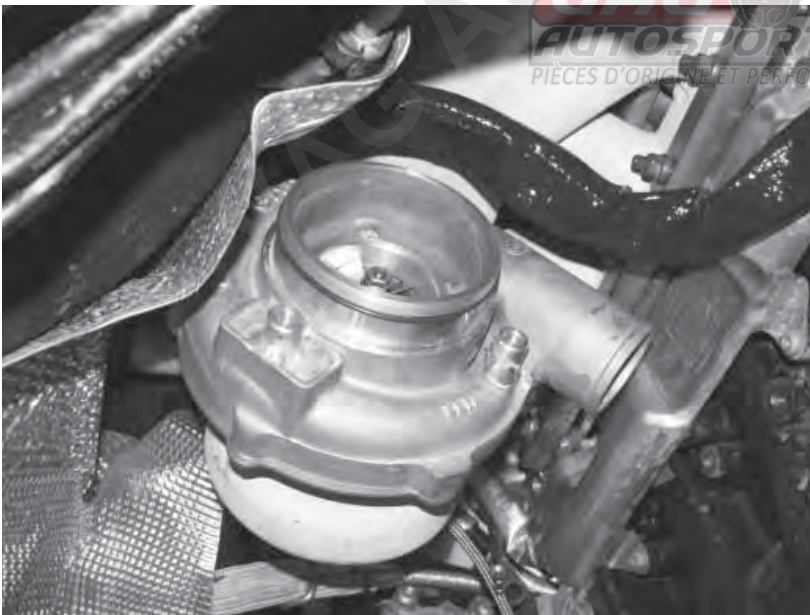

74) Install the o-ring on the turbocharger compressor, being sure not to get the o-ring twisted when installing it.

75) Install the coolant feed line on the back side of the turbocharger, using the 19mm banjo bolt with a crush washer on both sides of the banjo fitting. Before fully tightening the banjo bolt, slightly clock the line towards the right side of the turbocharger, being sure the line does not touch the compressor side of the turbo.

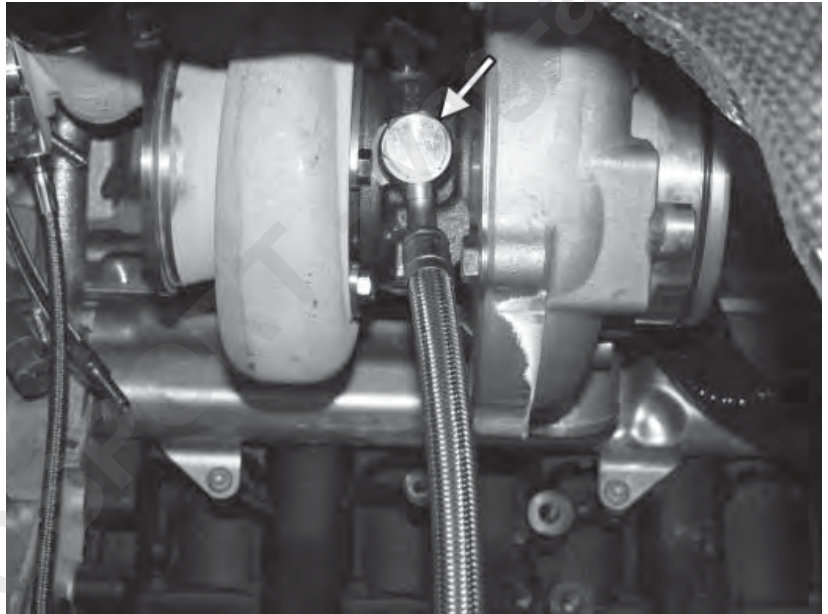

76) Loosely assemble the coolant distribution hose as shown, using the two larger and two smaller hose clamps, as well as the barbed fitting. Install the supplied larger heat sheathing over the coolant feed line, as well as the smaller heat sheathing over the lower wastegate coolant line that comes off the bottom of the wastegate.



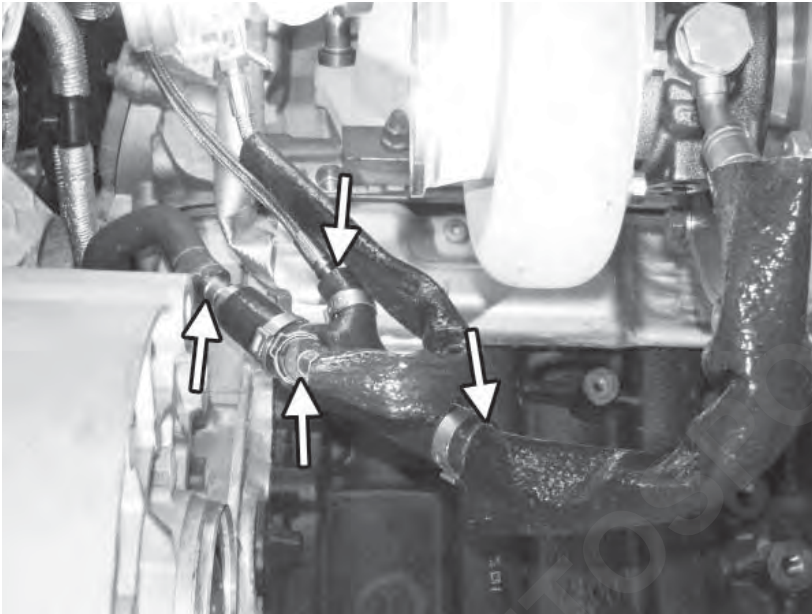

77) Loosely install the coolant distribution hose onto the APR coolant feed line. Then connect the other end of the distribution hose to the stock red coolant hose. One port of the distribution hose should be facing up, and the other should be facing the rear of the car. The two wastegate coolant lines are then attached to the distribution hose, with the bottom wastegate line going into the rearward facing port of the distribution hose.

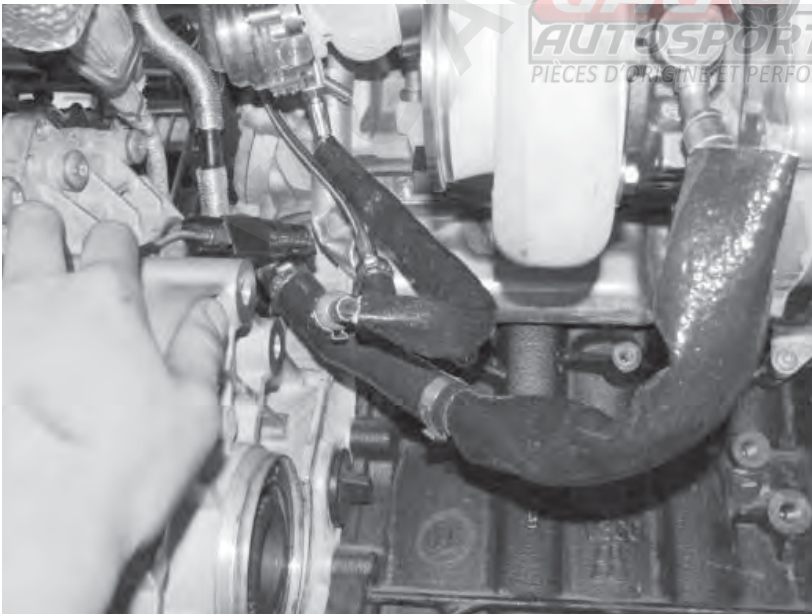

78) Once all the coolant feed lines are in the correct locations, crimp all the clamps in place. The spring clamp is reused on the original OEM red coolant line.

79) Install the supplied heat sheathing to the coolant return line, and then install it to the back of the engine block, making sure the supplied o-ring is in place and does not get pinched. Using the existing T30 Torx screw, tighten the coolant return line in place. Torque the screw to 80lb-in.

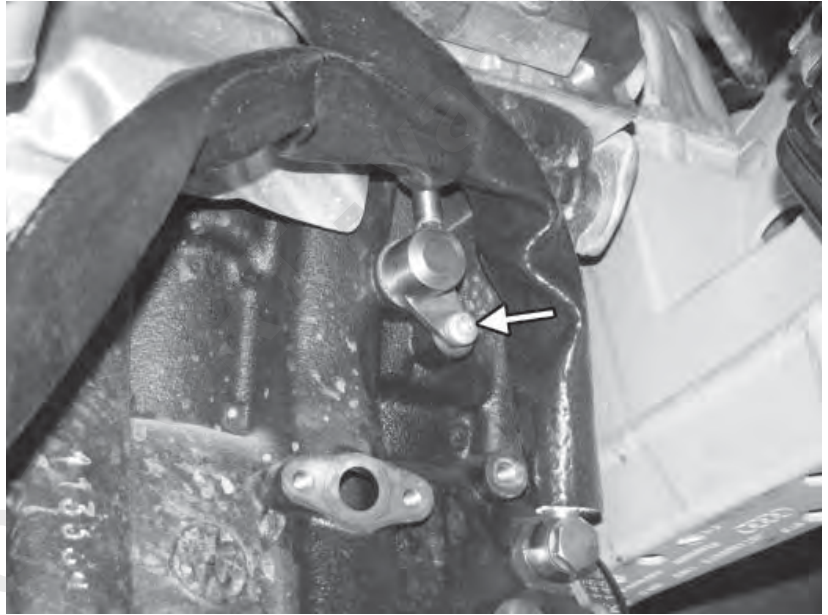

80) Connect the other end of the coolant return line to the front side of the turbocharger. Install the supplied 19mm banjo bolt with a crush washer on both sides of the banjo fitting.

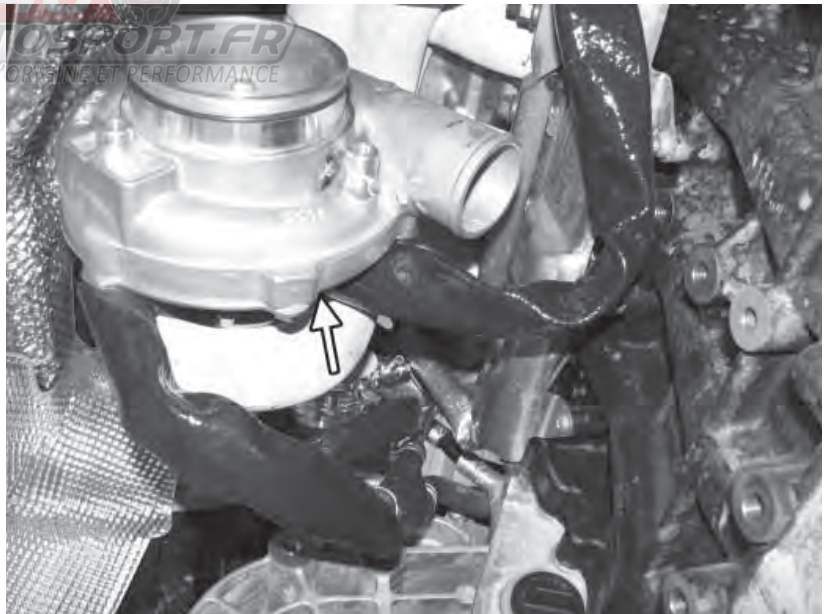

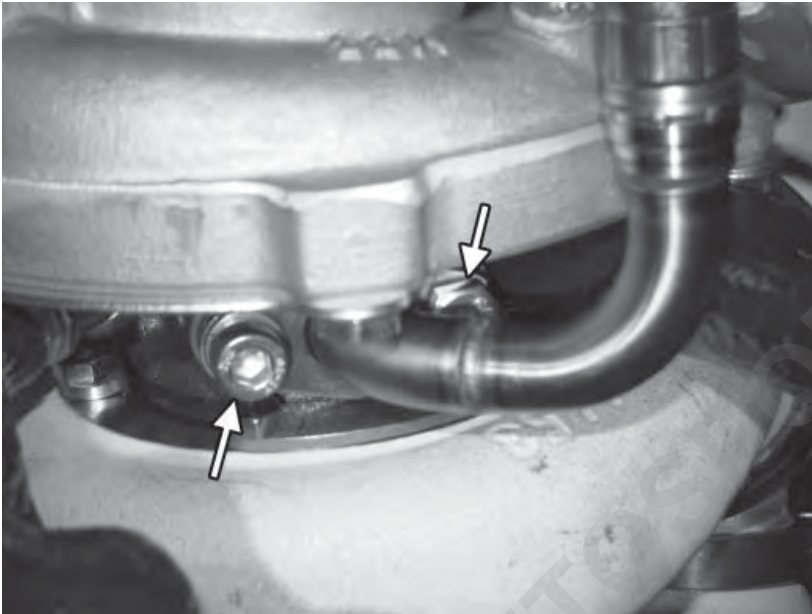

81) Install the APR oil drain line with gasket on the bottom of the turbocharger. Install the line with the slotted side of the line facing forward. The supplied 13mm hex bolt goes in the front hole on the bottom side of the turbo, and the 6mm allen bolt goes on the rear hole in the bottom of the turbo.

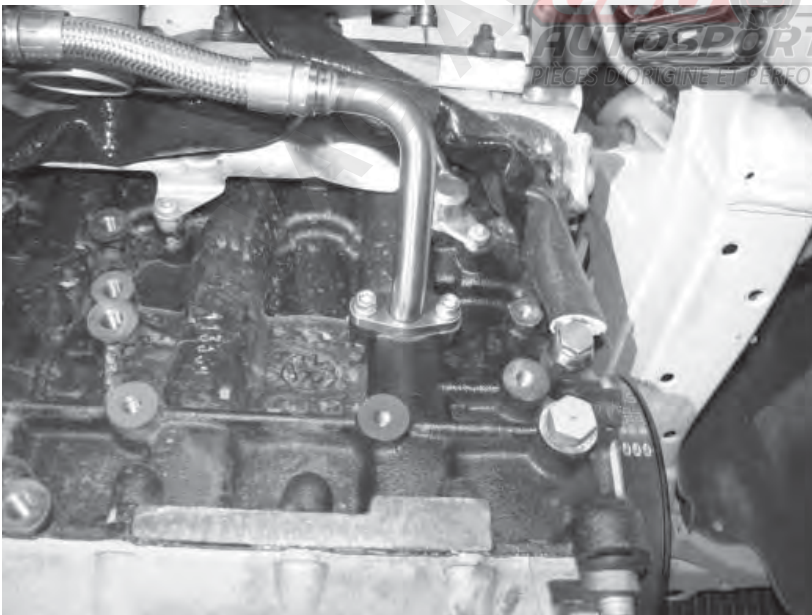

82) Install the other side of the oil drain line onto the engine block with the new supplied gasket and two 5mm allen bolts and torque the bolts to 80lb-in.

83) Using one of the supplied metal zipties, connect the coolant feed line, coolant drain line, and the "longer", bottom wastegate coolant line together. Note that the transfer case will be right below these lines, so they need to be lifted up as much as possible, but without touching any of the turbocharger. Cut away any of the excess length of the ziptie, and fold back the end as it can be very sharp.

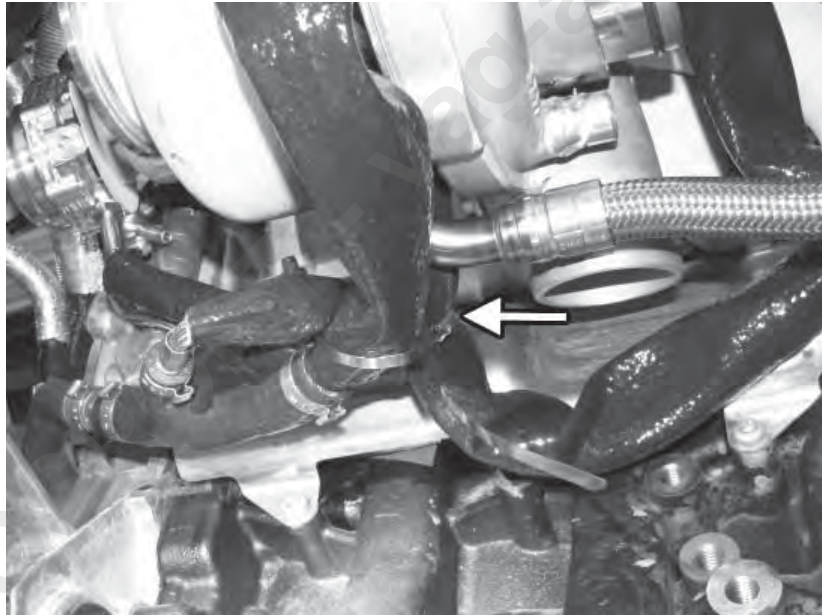

84) Install another metal ziptie to hold the coolant drain line to the oil feed line. In this case, note that the oil drain line needs to be off and away from the exhaust manifold. Cut away any of the excess length of the ziptie, and fold back the end.

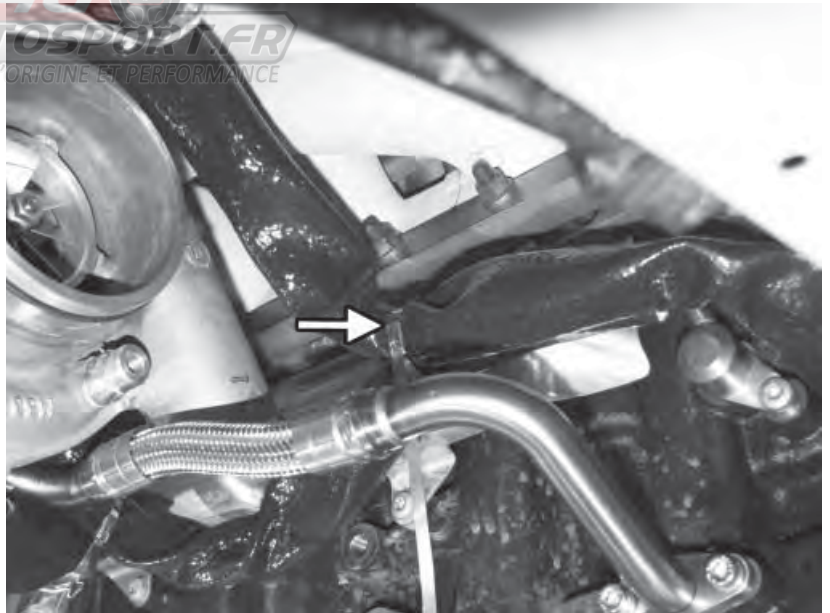

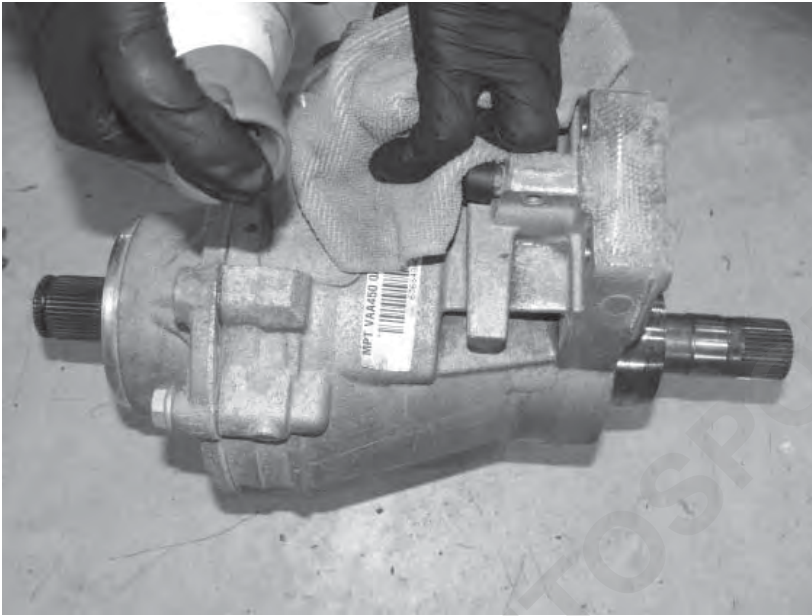

85) Clean the top of the transfer case with brake parts cleaner or some other solvent that does not leave a residue. Remove any stickers from the top of the transfer case.



86) Before peeling off the adhesive backing, carefully place and trim the supplied gold heat shielding to the transfer case. Cut small pieces that can overlap each other to cover most of the transfer case top.

87) Once pieces are cut, remove the adhesive backing and affix to the transfer case. Be sure to also cover the outside of the plastic breather hose cap, making sure it can still circulate air. The transfer case should be covered roughly as shown in this picture.

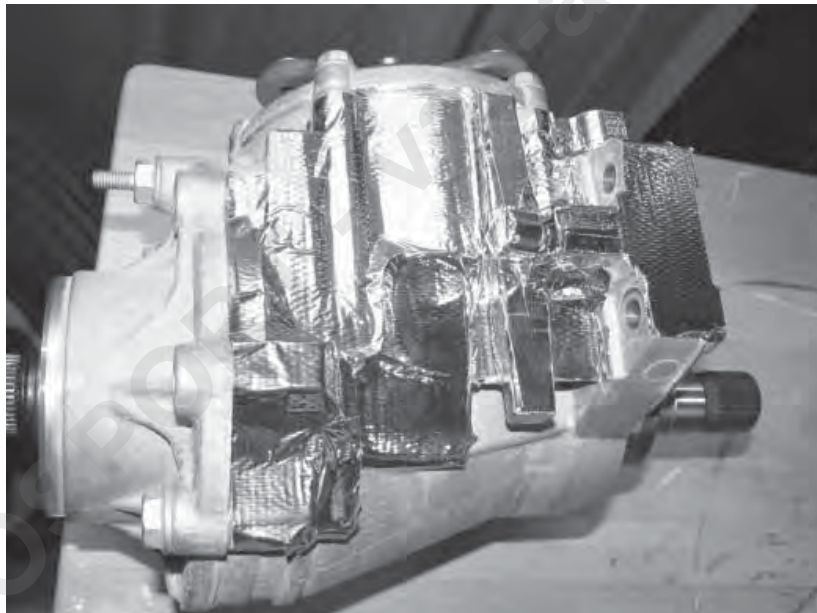

88) Install more of the gold heat shield to the top of the transmission, wrapping roughly between where the arrows are in the picture.

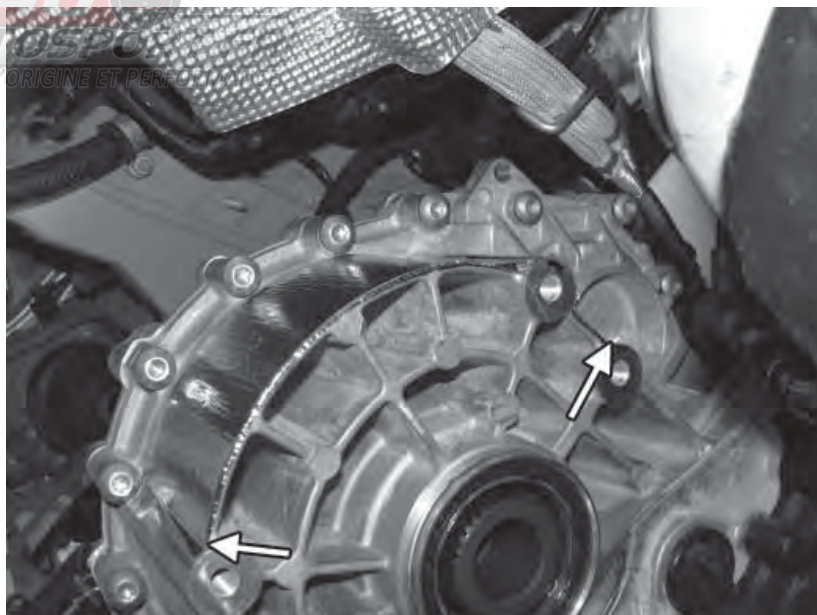



89) Remove the banjo fitting from the side of the wastegate. Install 50" of the supplied silicone hose to the fitting and crimp in place.

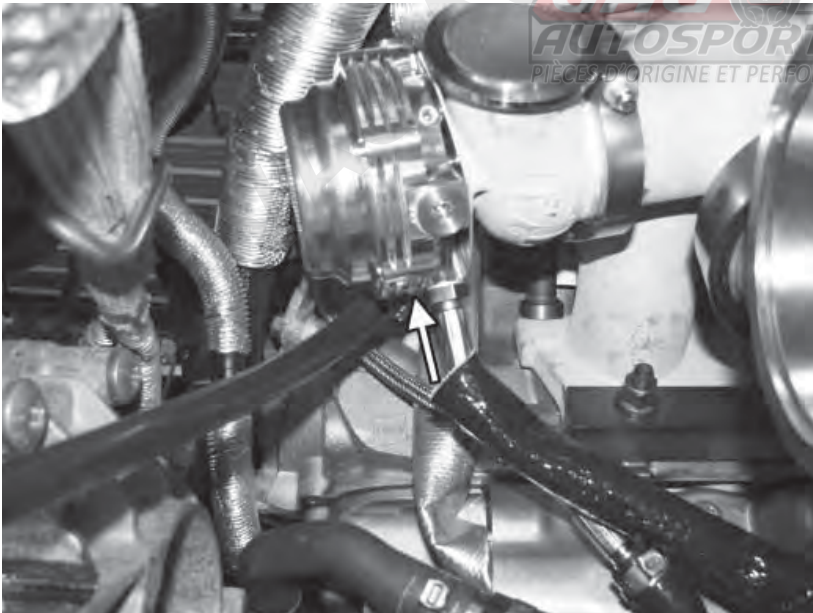

90) Reinstall the line to the side of the wastegate with a crush washer on each side of the banjo fitting. Before tightening the fitting, orient the line so that it faces down and at a 45° angle towards the left side of the car.

91) Install 48" of the smaller heat sheathing over the wastegate silicone line, running the sheathing all the way up to the wastegate.

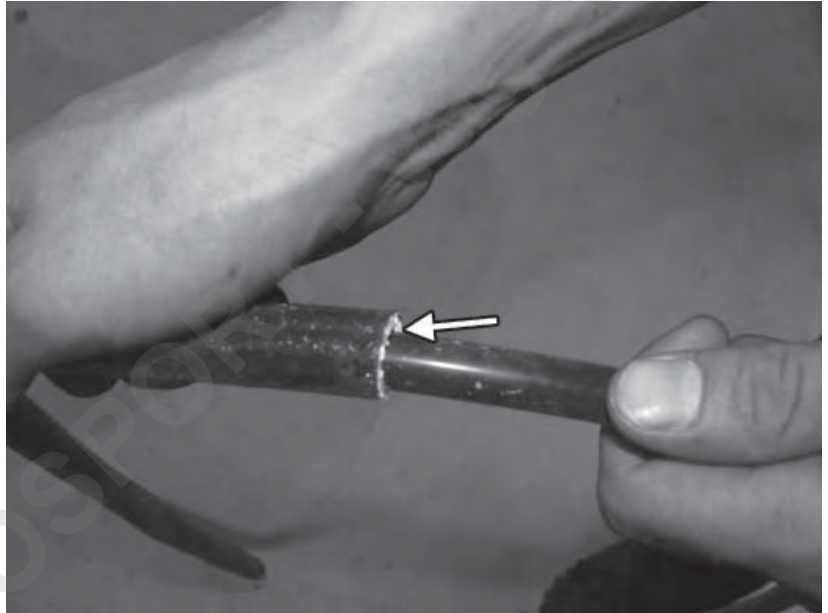

92) Route the wastegate hose under the shift cables and towards the left side of the car. Then, route the line up and above the stock coolant line that runs along the back side of the engine to the coolant reservoir. Finally, route the line behind the firewall heat sheathing, above the heater core lines and to the right side of the engine bay.

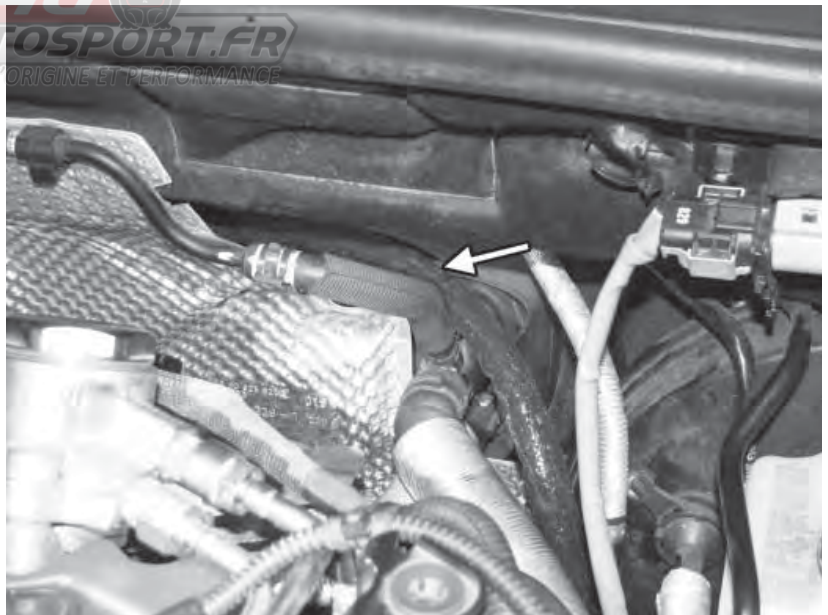

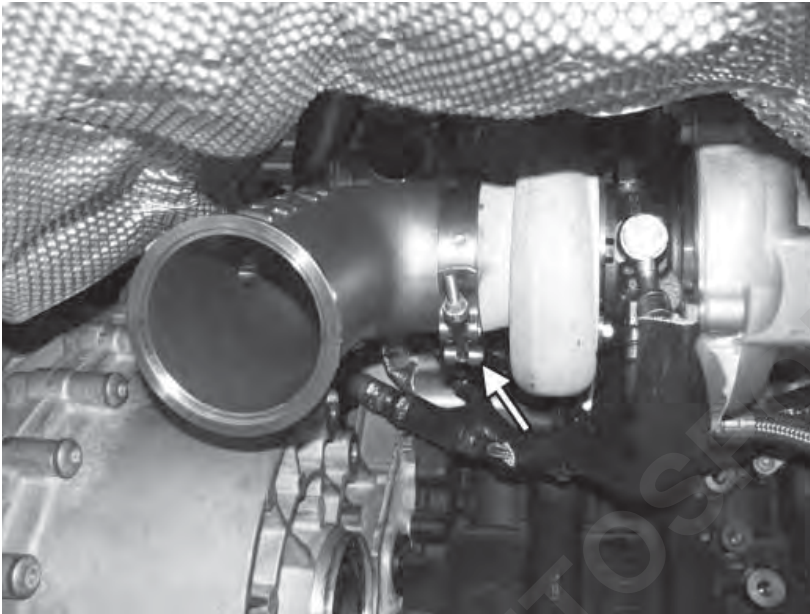

93) Install the APR downturn onto the turbocharger. Orient the V-band clamp so that the screw faces straight back towards the firewall, and is parallel to the ground. Tighten the clamp so that the downturn can still be rotated, but will not move on its own.

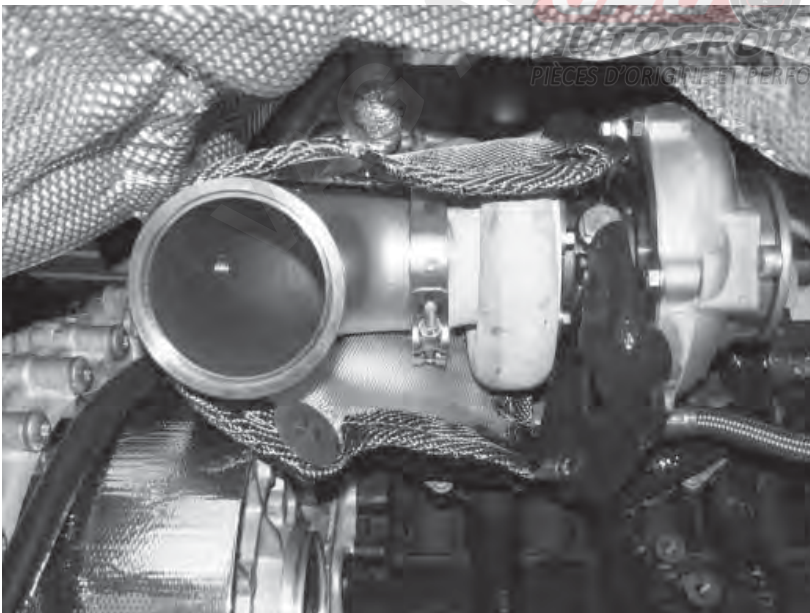

94) Wearing gloves to prevent splinters, carefully install the turbocharger blanket on the downturn and the turbine side of the turbocharger. The ring on the side of the blanket is for the primary oxygen sensor bung.

WARNING: It is **IMPERATIVE** that the blanket not get wet with any flammable fluids, including oil and coolant. Coolant **WILL** ignite at the temperatures the blanket will see, and will cause a fire. The blanket **WILL**, however, smoke heavily the first few times it is heat cycled.

95) Using the supplied wire, create a loop in one end of the wire.



96) Put the loop on one of the hooks on the turbo blanket, and then wrap the wire in a figure eight pattern between the two adjacent hooks. Once the connection is sufficiently connected, wrap the excess wire around itself to secure it.

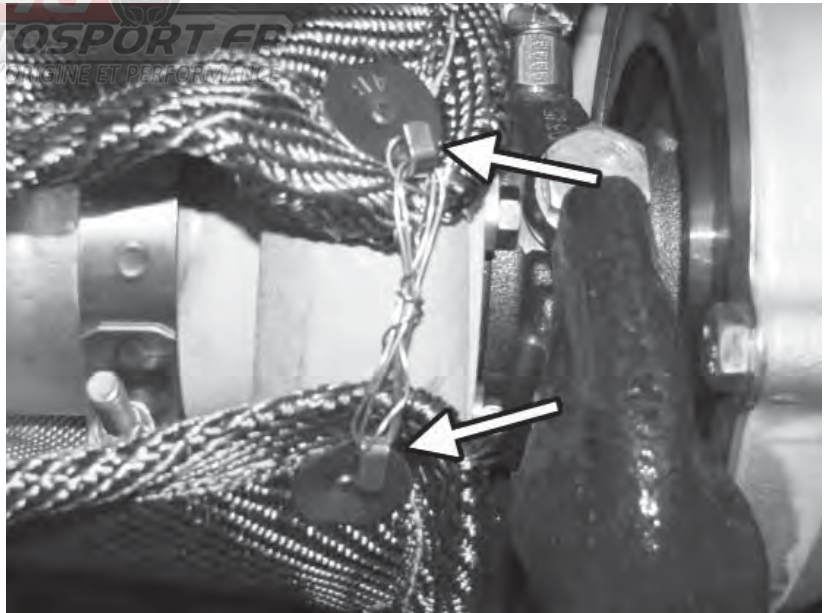

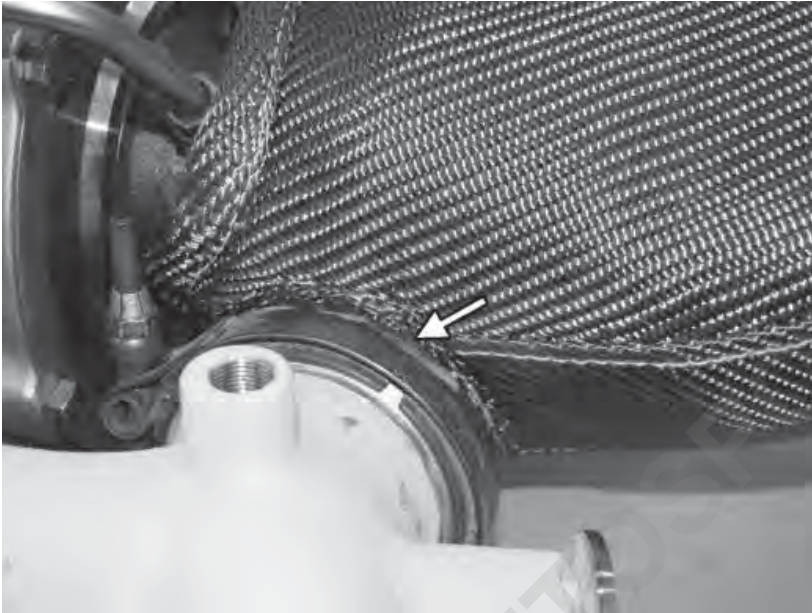

97) Loop the strap of the bracket across the turbine housing (as seen outside of the car), making sure the edge of the blanket goes underneath the manifold to turbo V-band clamp.

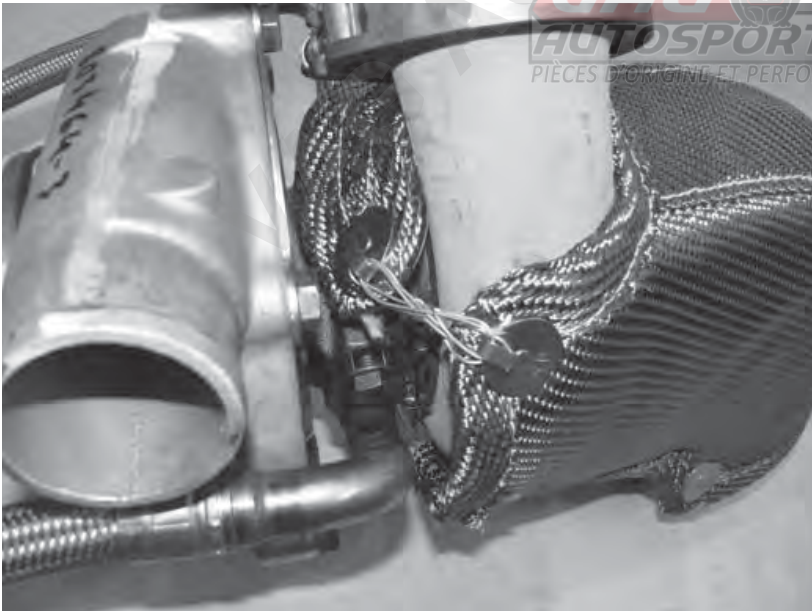

98) With the wire, repeat the wrapping procedure by wrapping the two hooks (shown) on the top of the blanket holding the strap in place.

99) Repeat the wrapping procedure by wrapping the two hooks (shown) on the bottom end of the downturn.



100) Reinstall the transfer case in the car, making sure the spines line up. Install the bottom two 16mm bolts and thread them all the way in by hand.

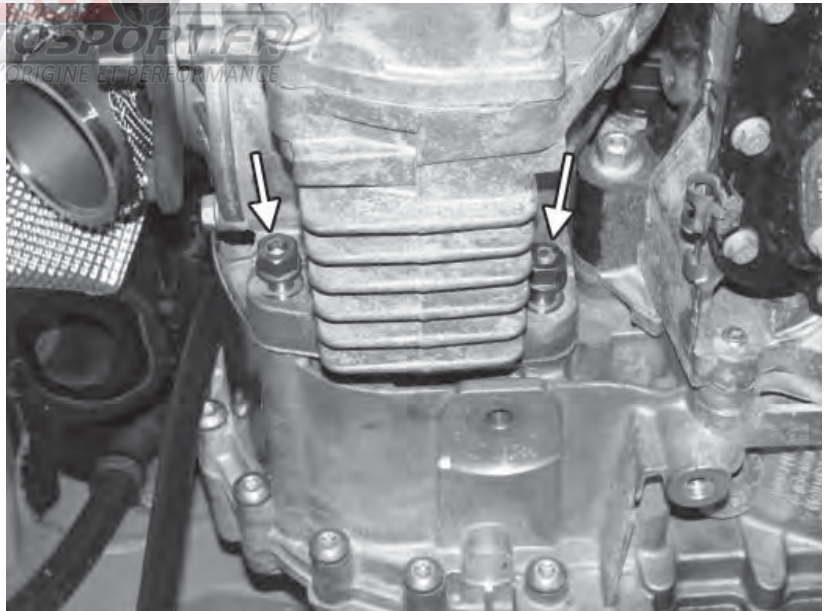

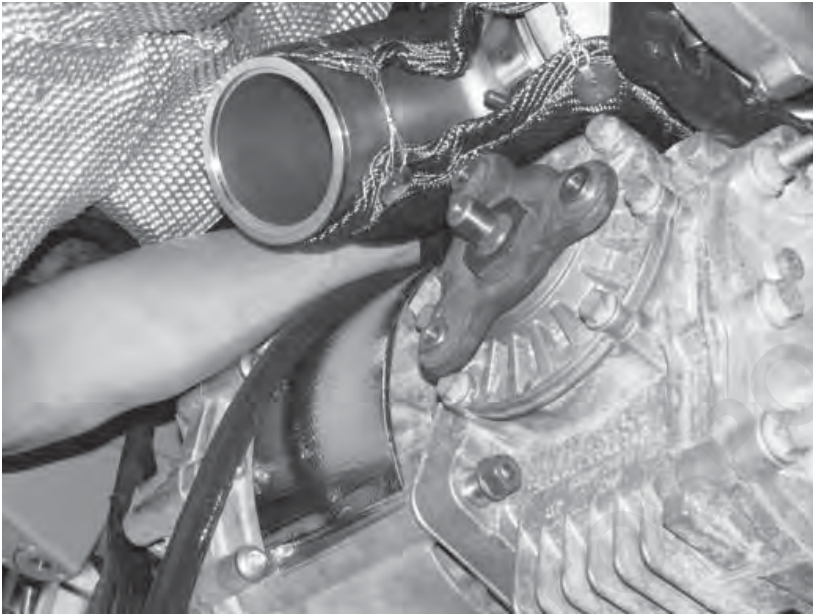

101) Install the two upper transfer case bolts by reaching around the top side of the transmission, and behind the downturn.



102) Tighten the upper bolt closest to the engine block using a regular 16mm socket with an extension with a wobble end.

103) Then, without removing the extension from between the transfer case and turbo, slide the tool over to the rear upper 16mm bolt of the transfer case. Be careful not to knock off the plastic breather cap that is on top of the transfer case when moving the tool. Tighten all four transfer case fasteners to 30lb-ft. Then tighten the bolts an additional 90°.

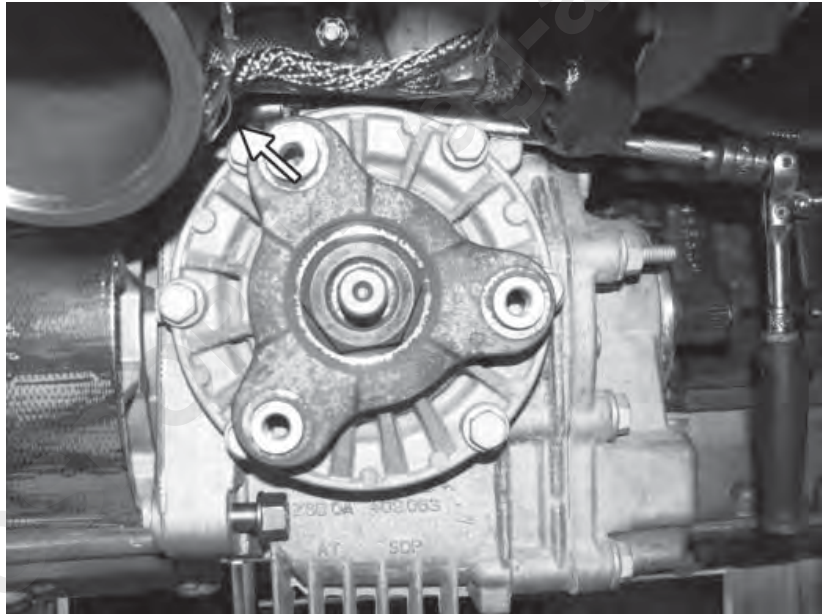

104) Reinstall the 6mm allen bolt that goes inside the end of the right side axle stub and torque the bolt to 26lb-ft.

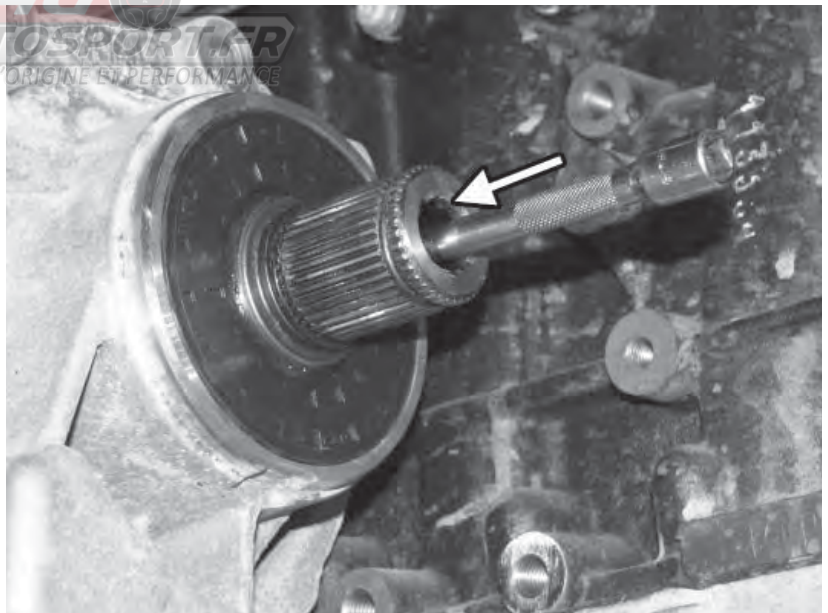

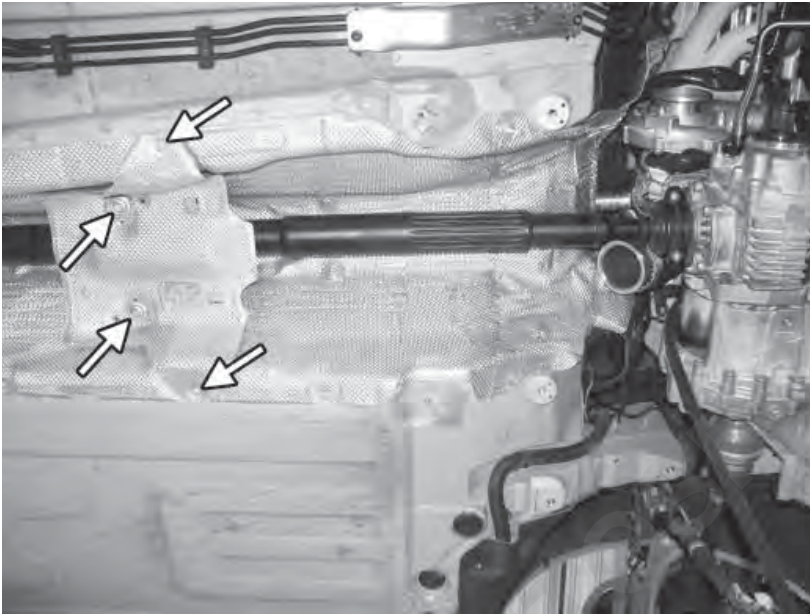

105) With an assistant, reinstall the driveshaft in the car by lining up first the front flange and then the rear flange of the driveshaft. Install the heat shield, and then install the two 13mm bolts to the carrier bearing as well as the two T30 screws. Finally, install the six 10mm 12point bolts to the front and rear driveshaft flanges. Torque the driveshaft bolts to 19lb-ft.

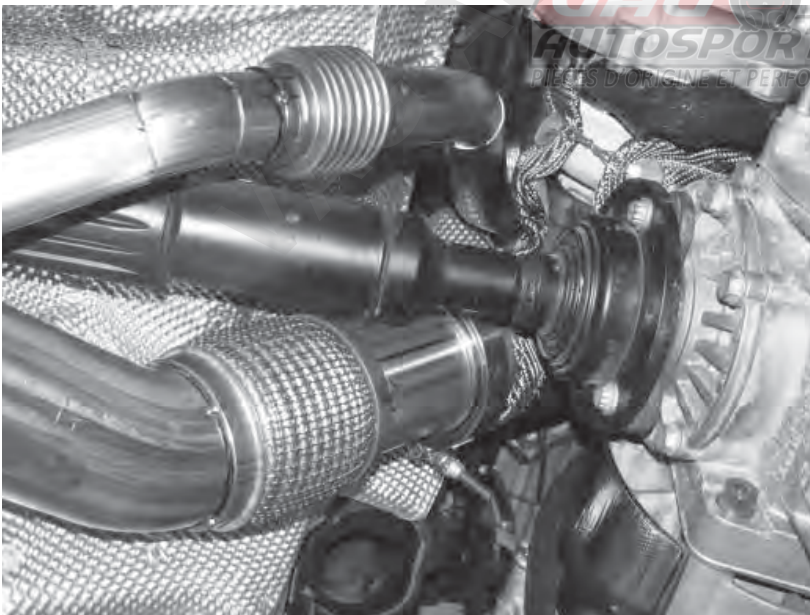

106) Install the downpipe in the car. Connect the V-band clamp to the downturn so the screw faces down and is pointed towards the front of the car. Tighten the V-band so the downpipe can still be rotated, but cannot move on its own.

107) Ensure the wastegate pipe of the downpipe connects easily to the wastegate. If necessary, rotate the downpipe at either the downpipe to downturn V-band connection or at the downturn to turbine housing V-band connection. The wastegate can also be rotated on the manifold, if necessary. Once correctly oriented, install the wastegate to wastegate pipe clamp. Tighten this enough to where it can still be rotated if necessary.



108) Take the stock N75 valve, and remove the two vacuum lines without a banjo fitting - from the top port as well as the port underneath the electrical connector. These two lines can be cut off of the N75 valve carefully with a razor blade. Finally, install some of the small heat sheathing over the remaining line.

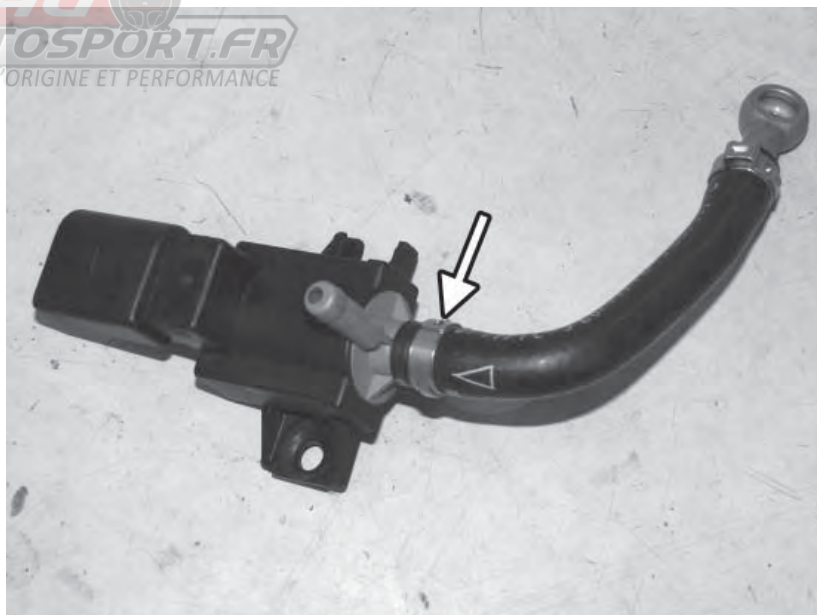

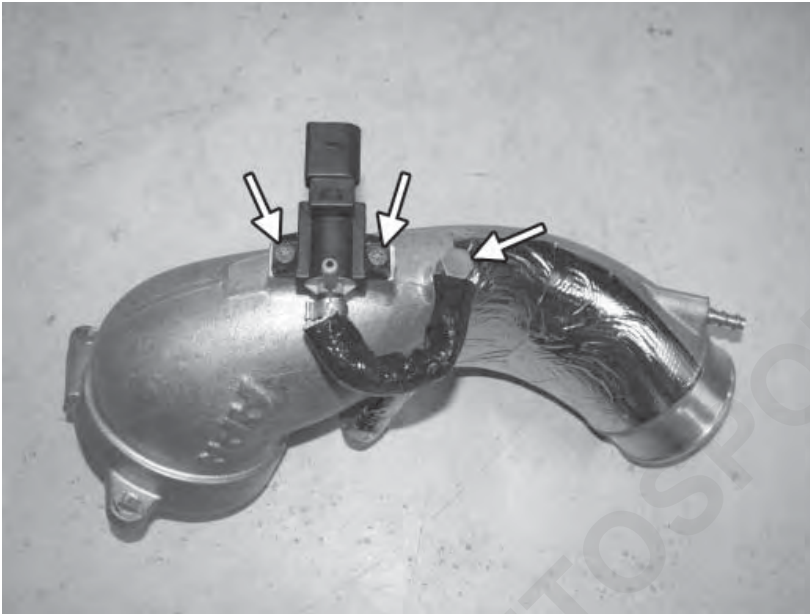

109) Using the two original T25 screws, install the N75 valve to the APR compressor inlet pipe as shown. Attach the banjo fitting to the port on the inlet hose with a crush washer on both sides of the banjo fitting, rotating the hose if necessary on the N75 valve. Once oriented correctly, crimp the hose clamp where the hose connects to the N75 valve.

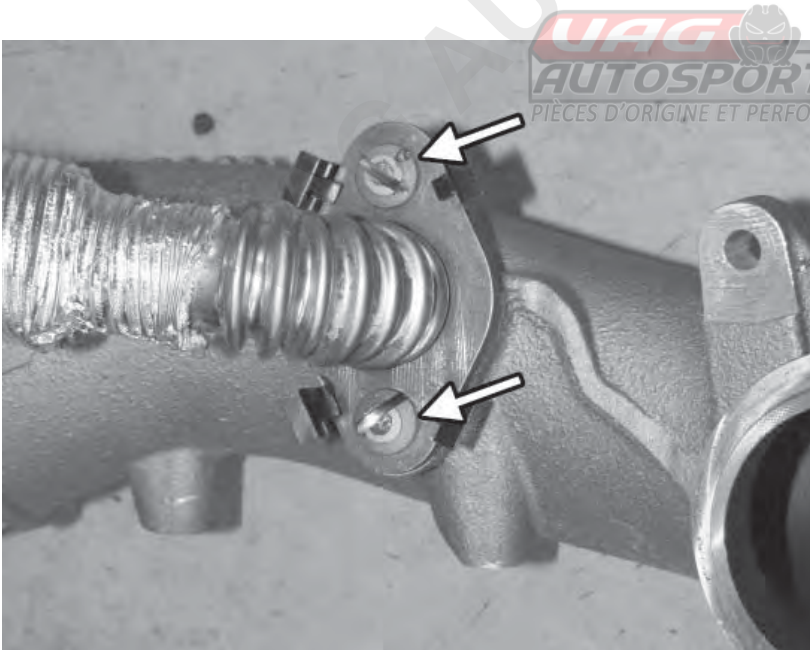

110) From the stock compressor inlet pipe, cut a slot in the two non-removable fasteners holding the breather pipe in place. Then, using a large screwdriver, remove the screws.

111) Install the previously removed breather tube to the compressor inlet hose using the existing gasket and the two supplied 5mm allen bolts and lockwashers. Also install the factory rubber coupler and one spring clamp that connects the upper side of the compressor inlet pipe to the stock air intake.



112) Install the compressor inlet pipe onto the turbocharger from underneath. As the pipe is being put into place, connect the electrical connector to the N75 valve. Being very careful with the N75 valve ports and electrical connector so as to not break them, seat the compressor inlet into its final position. Finally, loosely install the two 6mm allen bolts.

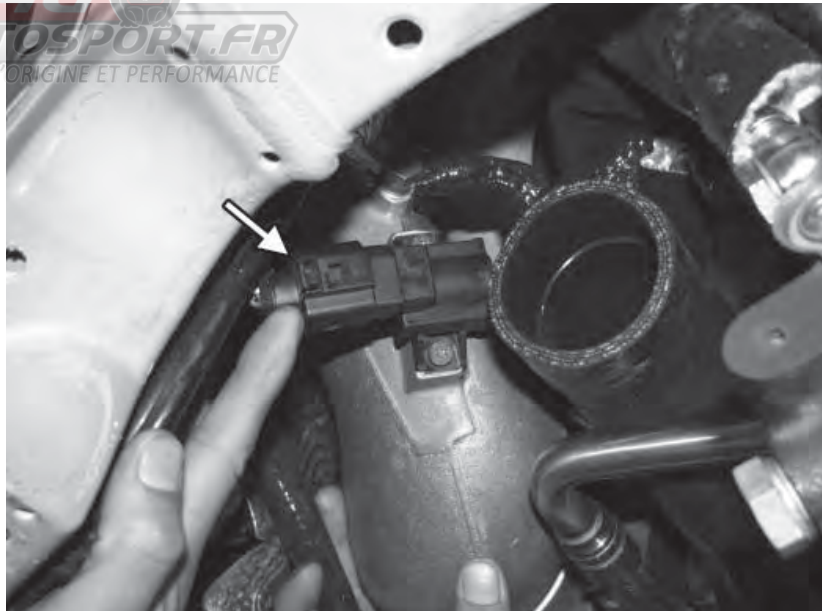

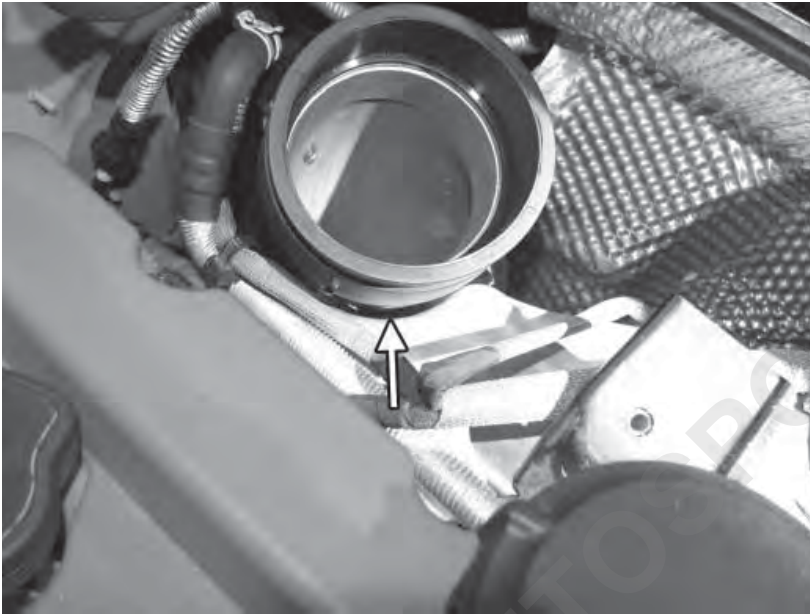

113) Make sure the compressor inlet pipe is spaced evenly away from the turbocharger heat shield. If necessary, rotate the compressor inlet pipe forward or back on the slotted mounting holes. When correctly spaced, tighten the two 6mm allen screws on the compressor inlet pipe.

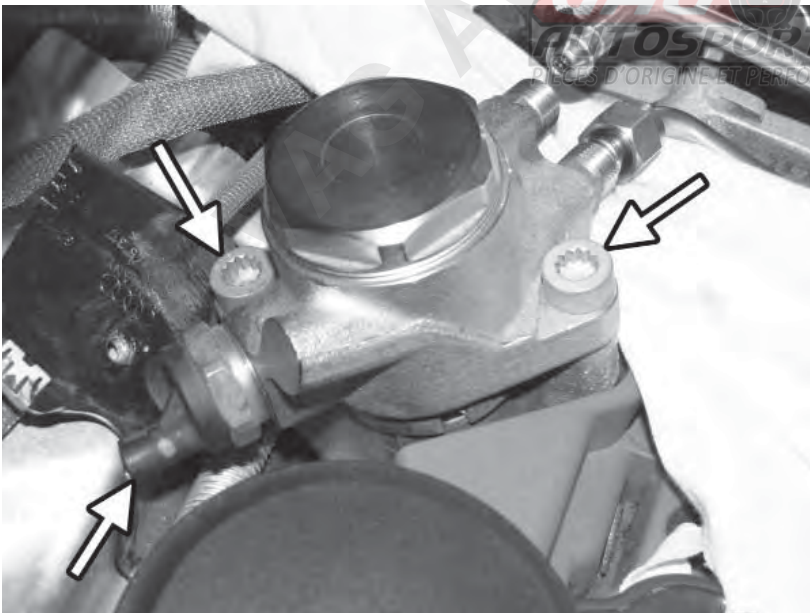

114) Reinstall the modified high pressure fuel pump using the two 10mm triple square bolts and torque to 15lb-ft. Reconnect the electrical connector to the pump.

115) Reinstall the two T30 screws to reconnect the factory fuel lines. Install the screw in the lower line first, then the upper line.

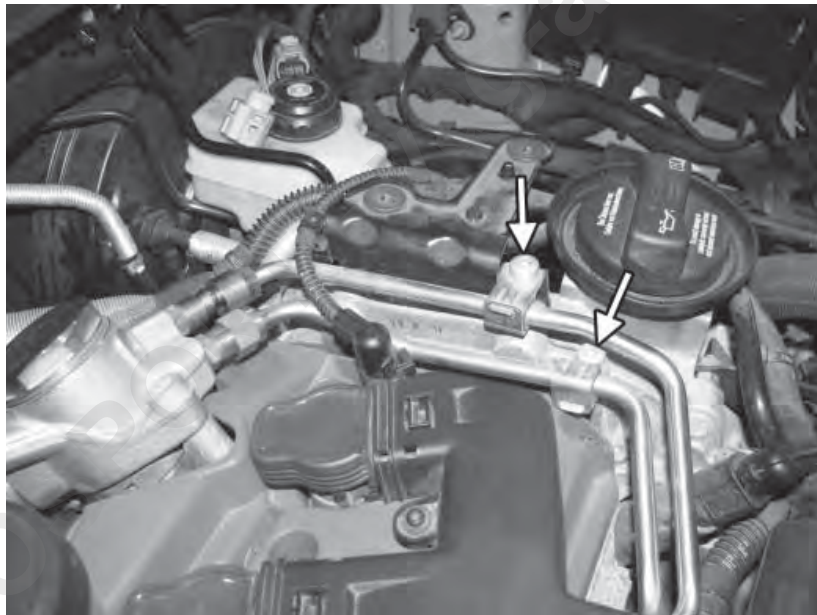

116) Reinstall the upper and lower fuel lines to the high pressure fuel pump. Hold the 14mm brass fitting to the lower line and tighten the nut with a 17mm wrench. Finally, hold the brass fitting on the upper line with a 14mm wrench and tighten the nut with a 15mm wrench.

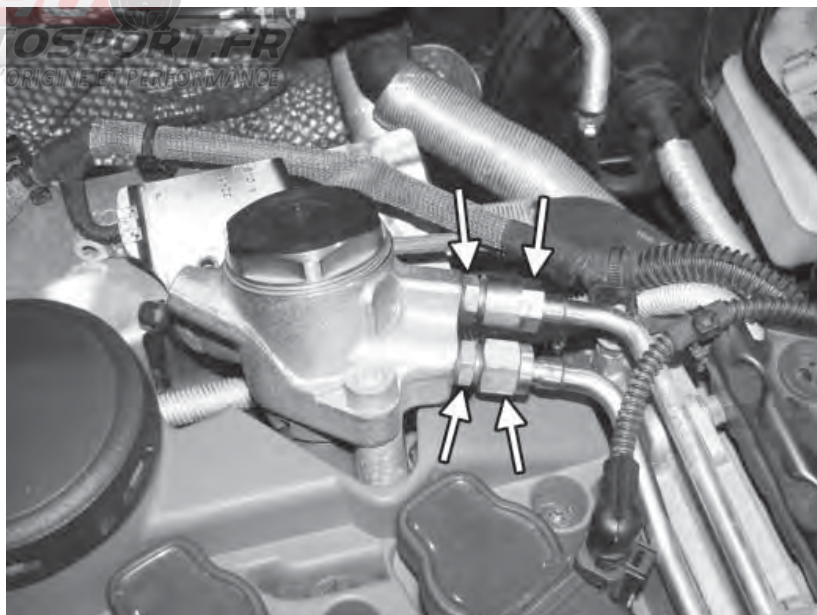

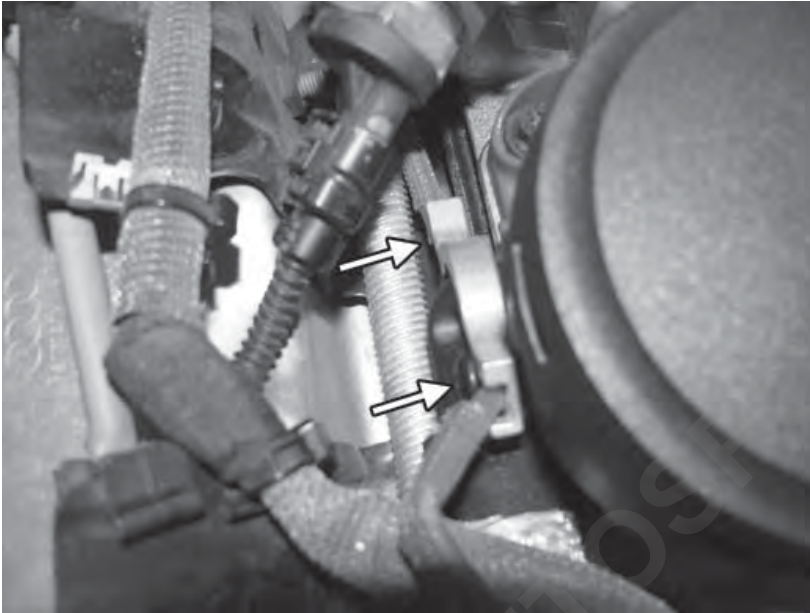

117) Reinstall the top of the stock PCV hose to the top side of the cylinder head using the factory metal brace. Install the two T25 screws, remembering to connect the ground strap to one of them.



118) Using a grinder, carefully trim the corner of the transfer case brace between the two upper holes that mount it to the engine block. The APR compressor outlet hose runs very close to this, so removing some material and smoothing out any sharp edges is critical to preventing chafing on the hose.

119) Reinstall the transfer case bracket, making sure the coolant hose is not pinched underneath it. Install the four 16mm bolts and two 16mm nuts, and torque to 30lb-ft.



120) Install the APR compressor outlet hose and attach to the turbocharger. Do not tighten the hose clamp at the turbocharger.

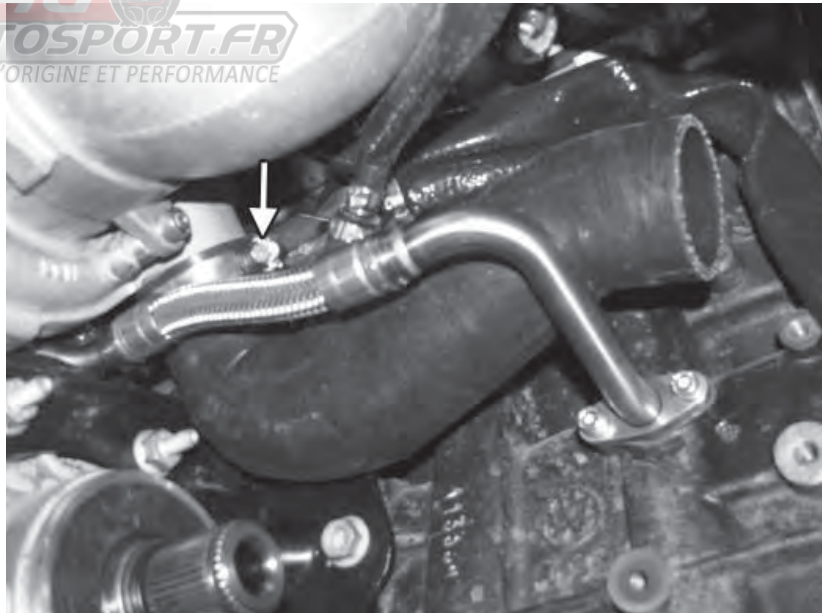

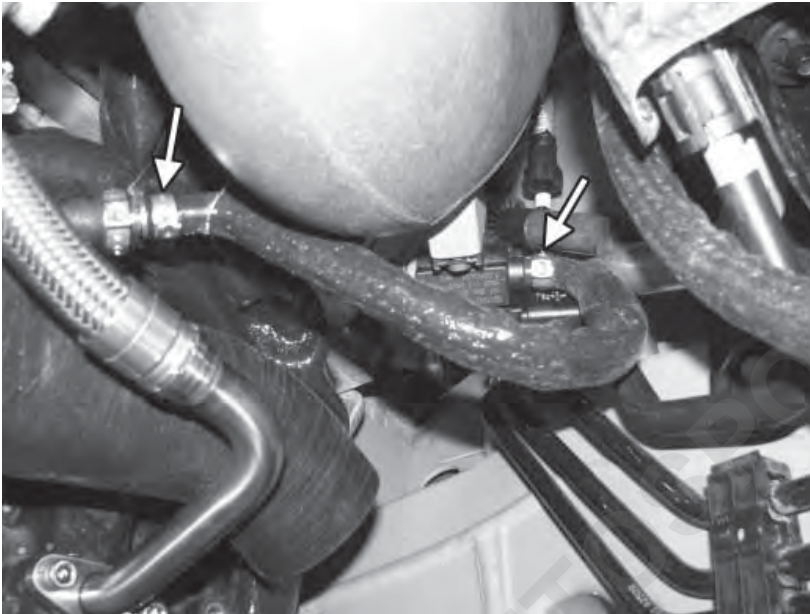

121) Install some of the smaller heat sheathing on the supplied silicone hose. Connect the N75 port underneath the N75 electrical connector to the barbed fitting on the compressor outlet hose, and secure with hose clamps.

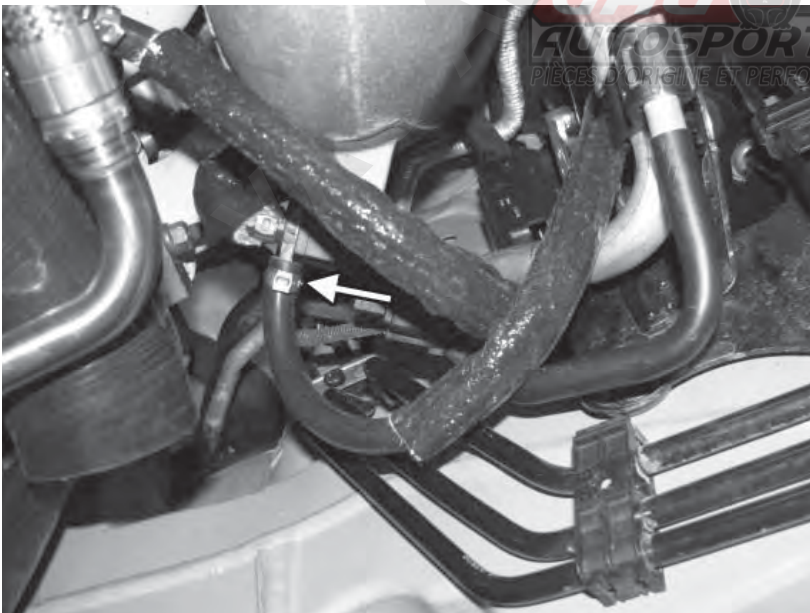

122) Connect the vacuum line that was routed from the wastegate to the top port of the N75 valve, and secure with a hose clamp.

123) Reinstall the pancake pipe on the side of the engine with its original 10mm triple square on the back of the engine and the T30 screw on the side. Connect and adjust the compressor outlet hose if necessary, and tighten both 7mm hose clamps on the compressor outlet hose. Connect and tighten the factory hose from the pancake pipe to the intercooler.

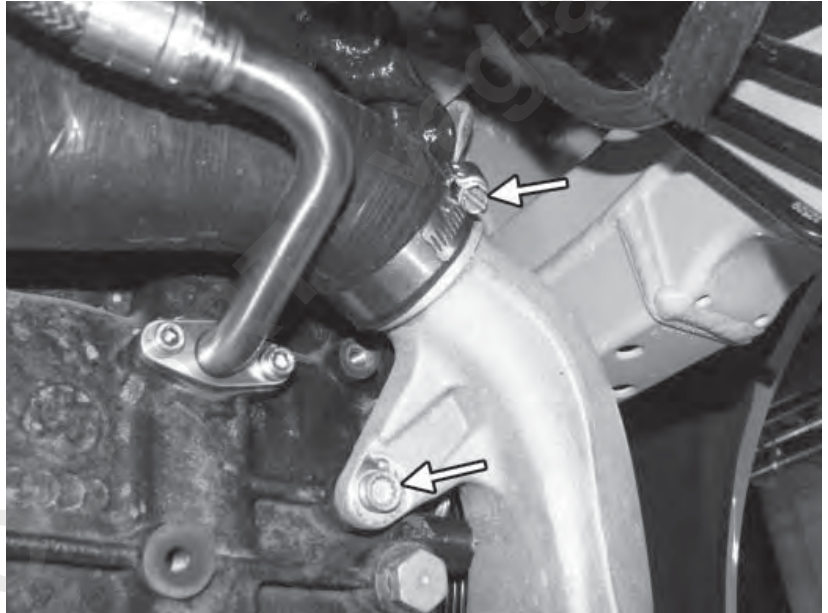

124) Install the supplied velcro heat shielding over the oil drain line.

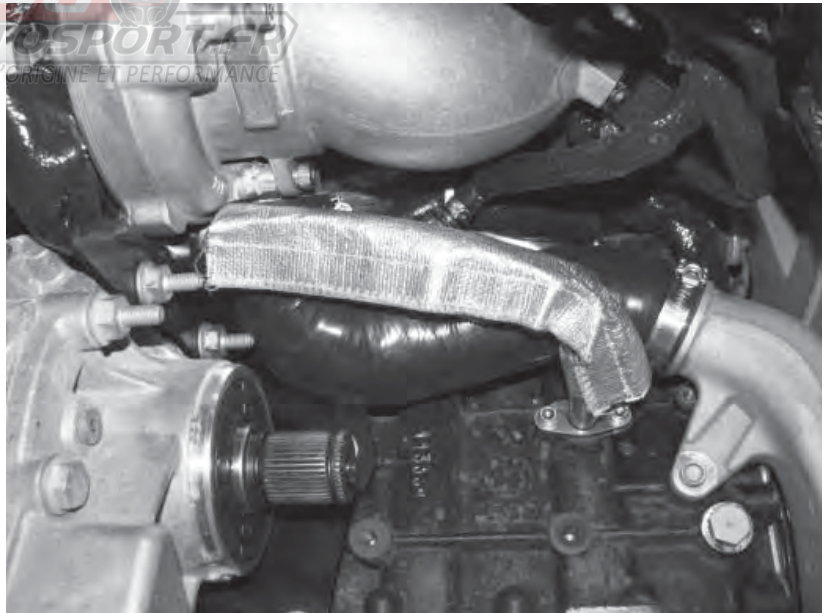

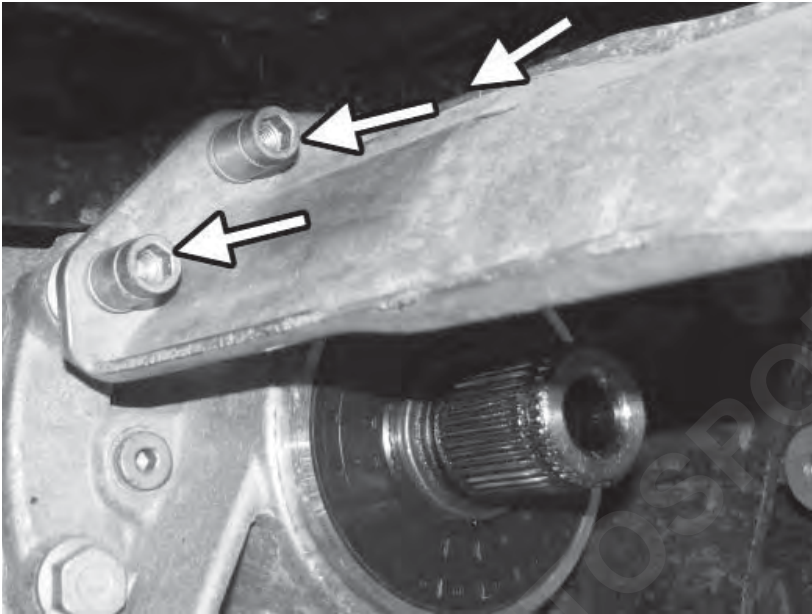

125) Reinstall the axle heat shield with the three 8mm allen nuts and tighten to 19lb-ft.

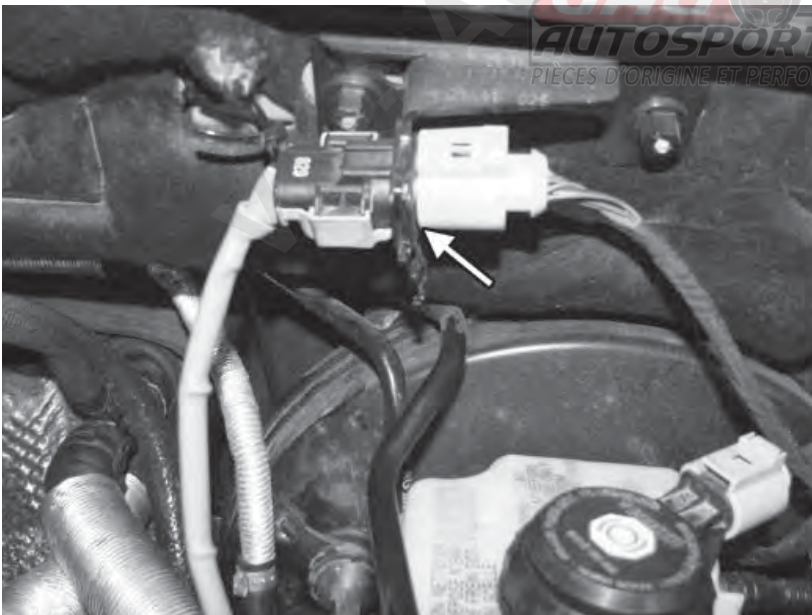

126) Reinstall the primary oxygen sensor in the side of the APR downturn. Route the wiring from the sensor up and connect it to the correct electrical connector on the firewall. Finally, clip the connector in the stock location on the firewall.

127) Using a transmission jack, raise the subframe until it is about 3" from its final mounting location. Install the one 10mm bolt that holds the steering rack wiring harness to the subframe.

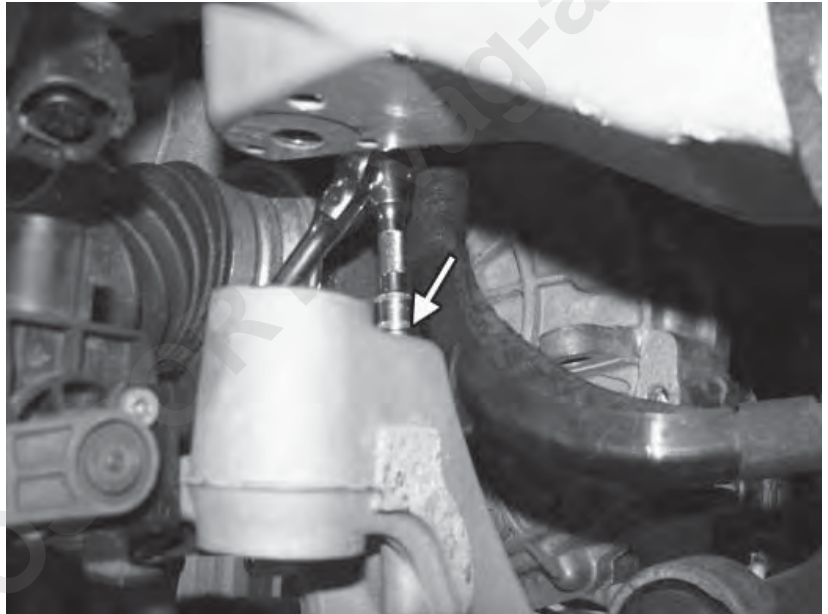

128) Route the wiring harness down, bringing the oil level sensor portion of the harness towards the front of the subframe. Reconnect the oil level harness in the factory mounting clips and reconnect to the oil level sensor.

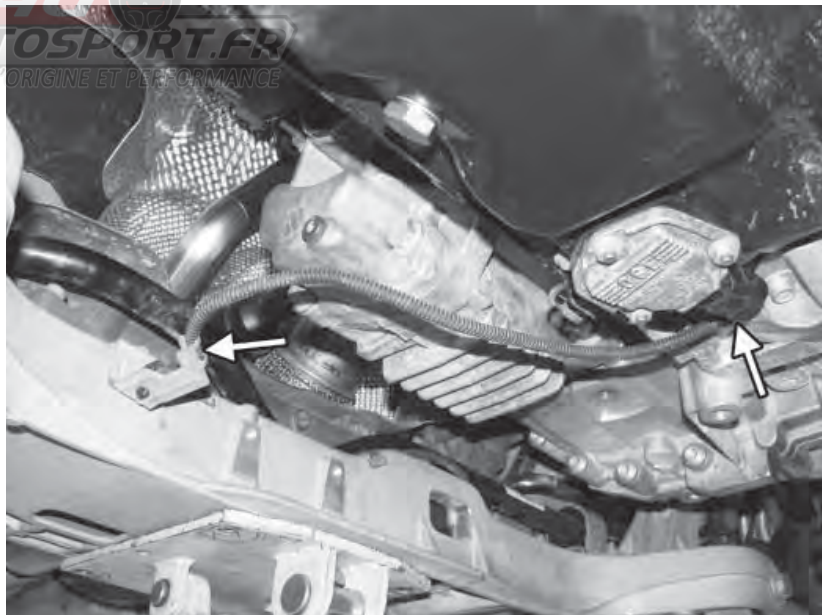

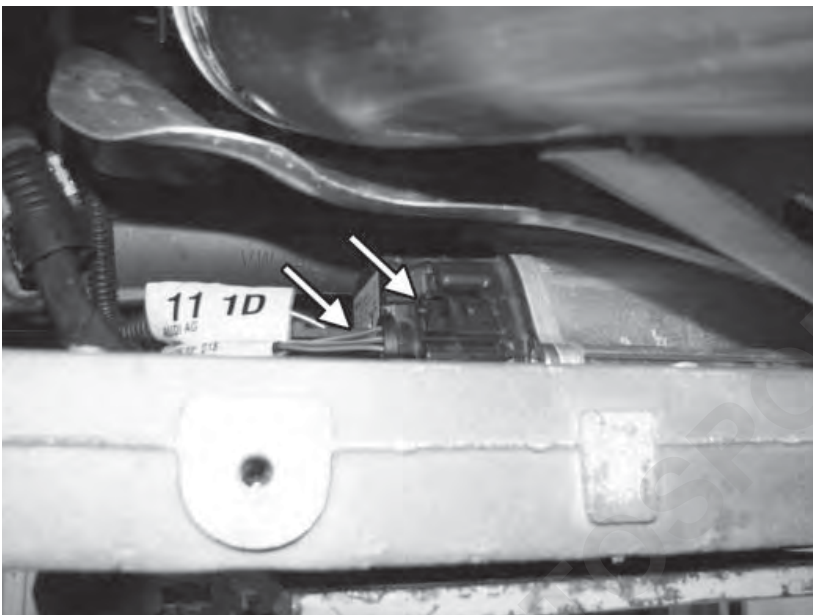

129) Reconnect the two electrical connectors to the electromechanical steering rack.

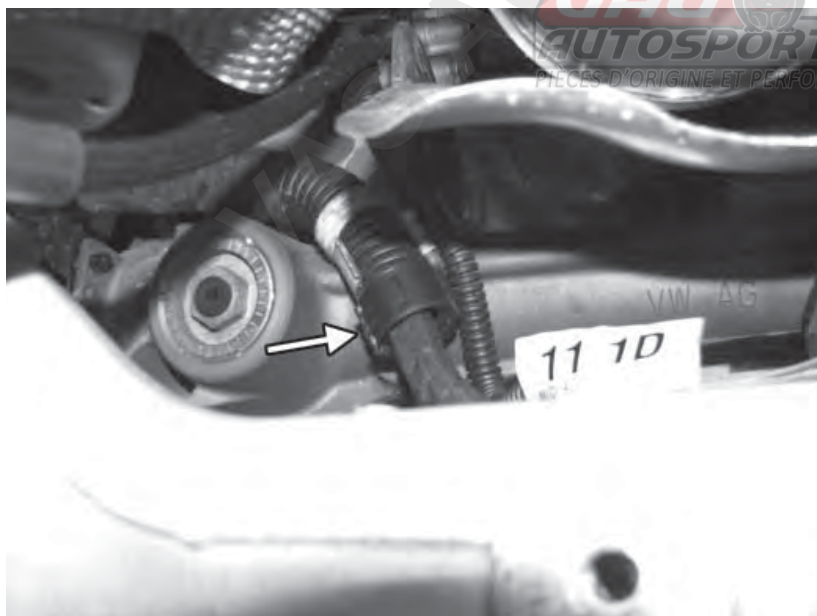

130) Reconnect the steering rack wiring harness to the existing factory clip to prevent it from moving. Be sure to bend the factory heat shield back down over the connectors.

131) Connect the oxygen sensor extension cable (supplied with the midpipe of the exhaust) to the appropriate connector on the engine firewall. Route the cable down towards the back of the subframe, making sure the cable goes behind the the primary oxygen sensor cable. On LHD cars, route the cable to the right side of the steering linkage.

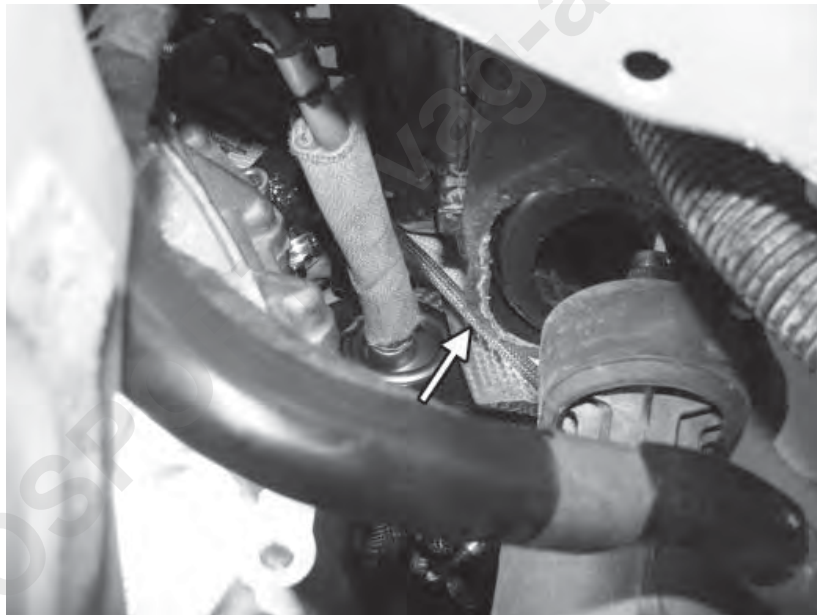

132) Remove the 10mm nut that connects the lower portion of the firewall heat shield to the firewall. Route the extension cable on the right side of the body stud so that the heat shield retains the wire with the 10mm nut reinstated. Take care to bend back any sharp edges of the heat shield so they will not cut into the cable.

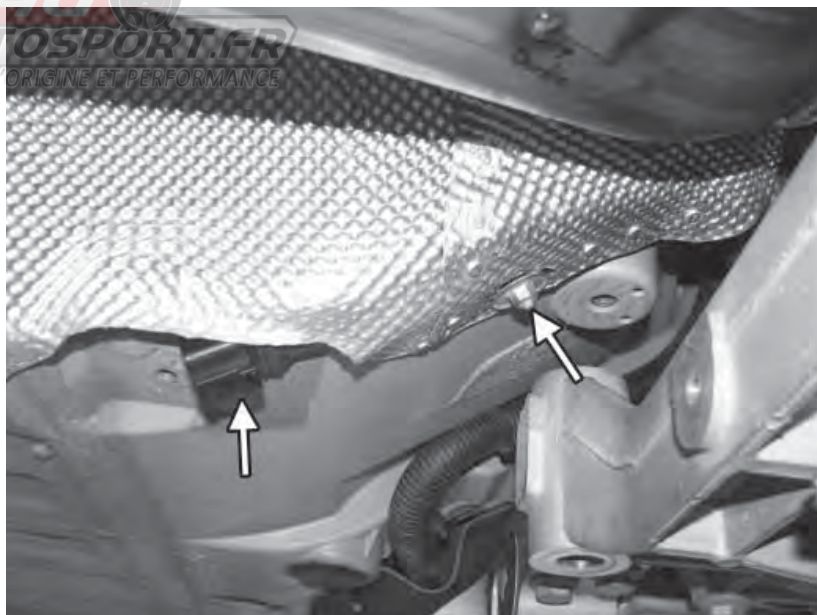

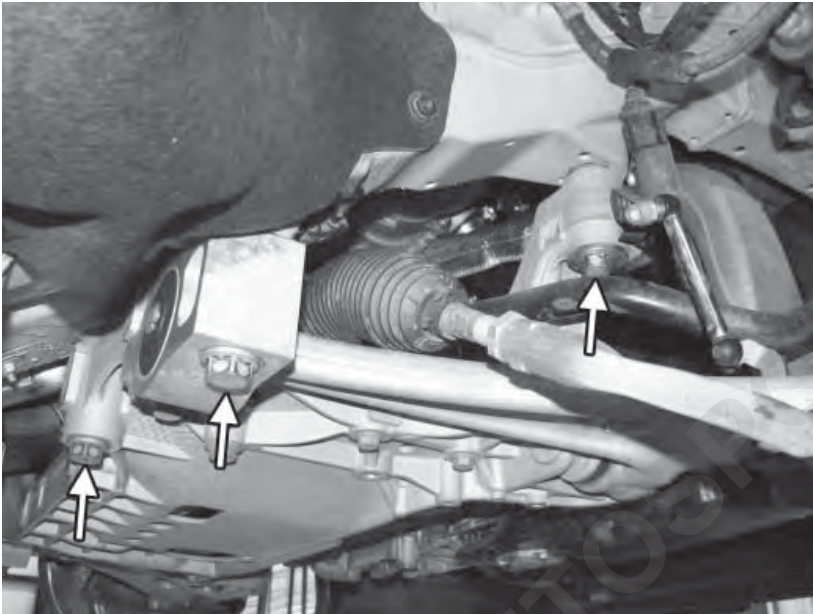

133) Raise the subframe up to its final mounting location. The 21mm bolts with the shorter threads go in the inner, rear holes, the 21mm bolts with the longer threads go in the outer holes, and the 18mm bolts go in the front mounting holes. Torque the bolts to 52lb-ft, and then tighten an additional 90°.

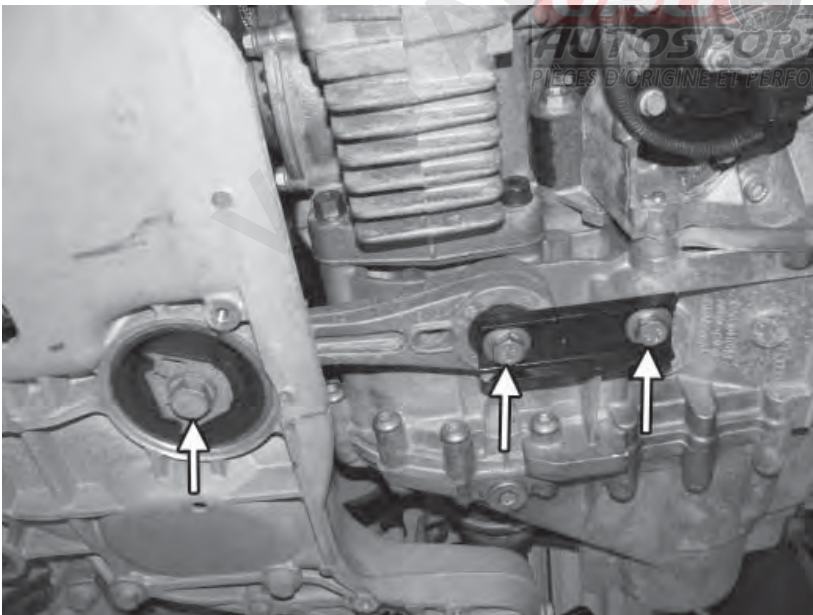

134) Reconnect the lower center engine mount. The 21mm bolt goes in the subframe mount and is torqued to 74lb-ft, and then tightened an additional 90°. The shorter 16mm bolt mounts to the front of the engine, and the longer one is on the back of the engine. Torque the two 16mm bolts to 30lb-ft, and then tighten an additional 90°.

135) Remove the downpipe isolation mount from the stock exhaust, and mount the APR downpipe bracket to it. With the factory cross brace mounted between the downpipe isolation mount and the subframe, install the two 13mm bolts that hold the brace and isolation mount to the subframe.



136) Mount the first section of the exhaust midpipe to the downpipe, and install the secondary oxygen sensor.

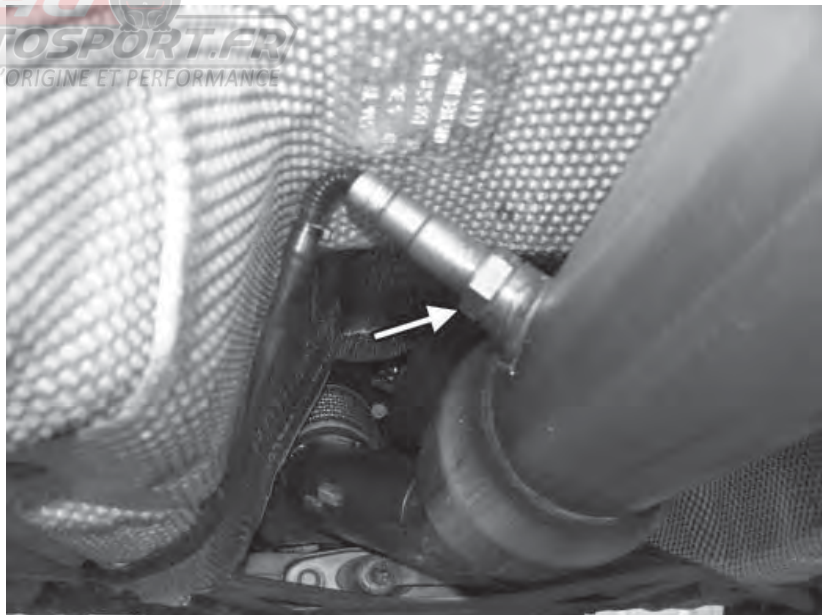

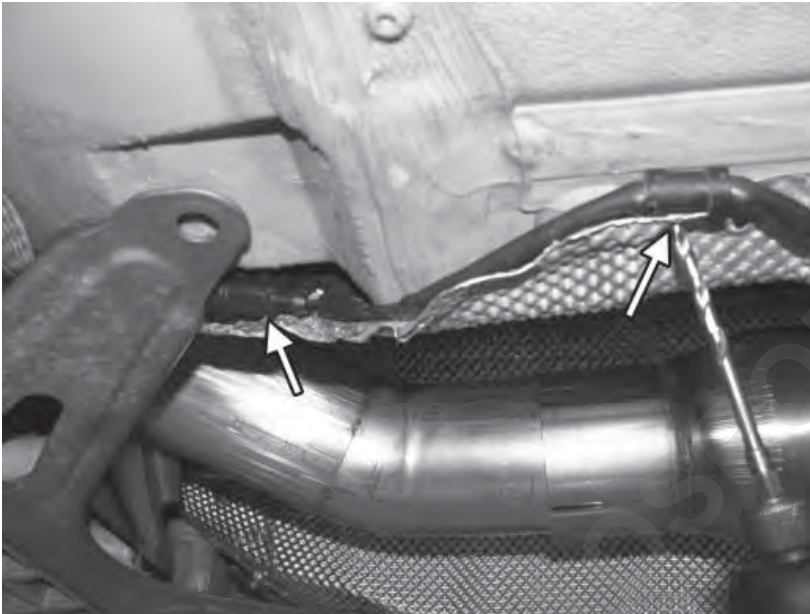

137) Route the wiring harness from the secondary air sensor over to the connector on the extension cable and connect it. It will be necessary to create a "pocket" behind the heat shield for the electrical connection to sit in to allow the exhaust cross brace mount correctly. Finally, drill a small hole in the heat shield next to the plastic grommet that is on the oxygen sensor wire.

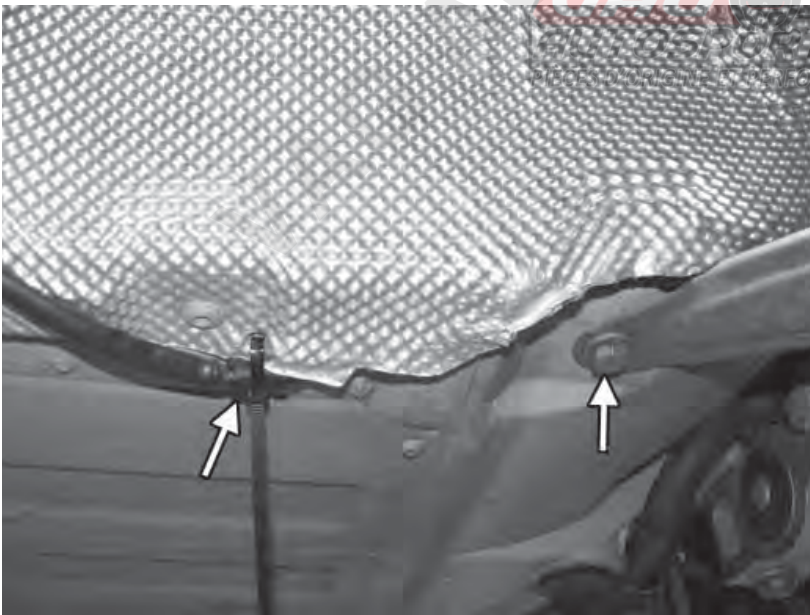

138) Using a zip tie, mount the oxygen sensor wire at the plastic grommet to the heat shield. With the electrical connector in the "pocket" that was created, reinstall the two 13mm bolts on the exhaust cross brace. Fully tighten all four 13mm bolts on the cross brace.

139) Install the 15mm bolt and 15mm washer to connect the downpipe to the APR downpipe bracket.

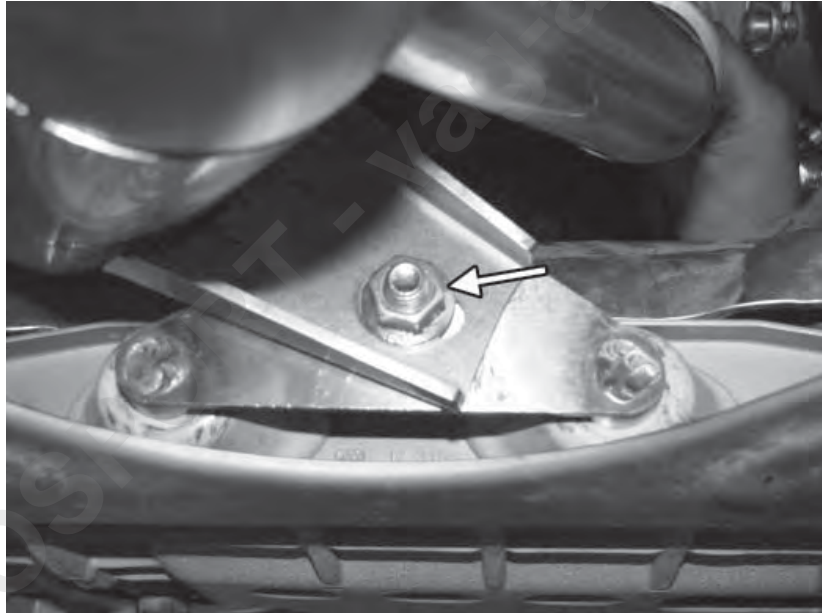

140) Tighten the downturn to downpipe 11mm V-band clamp.

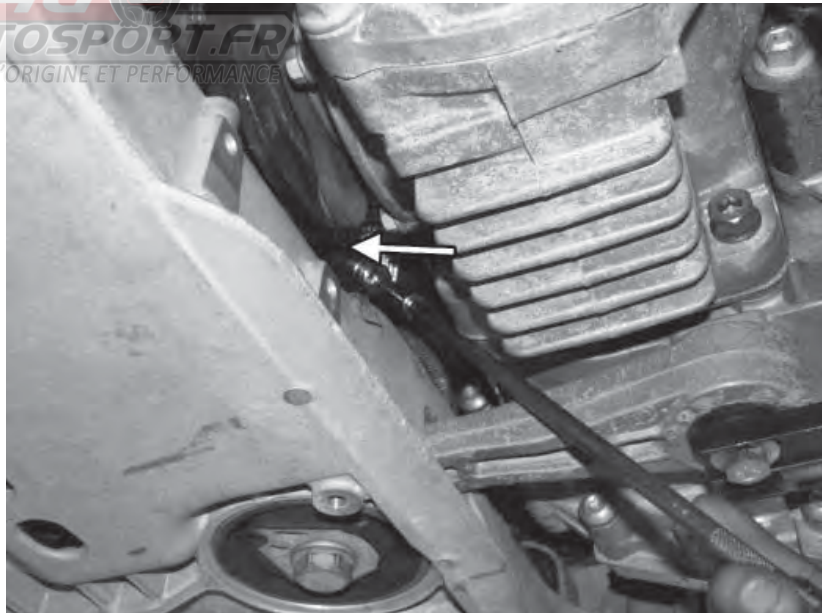

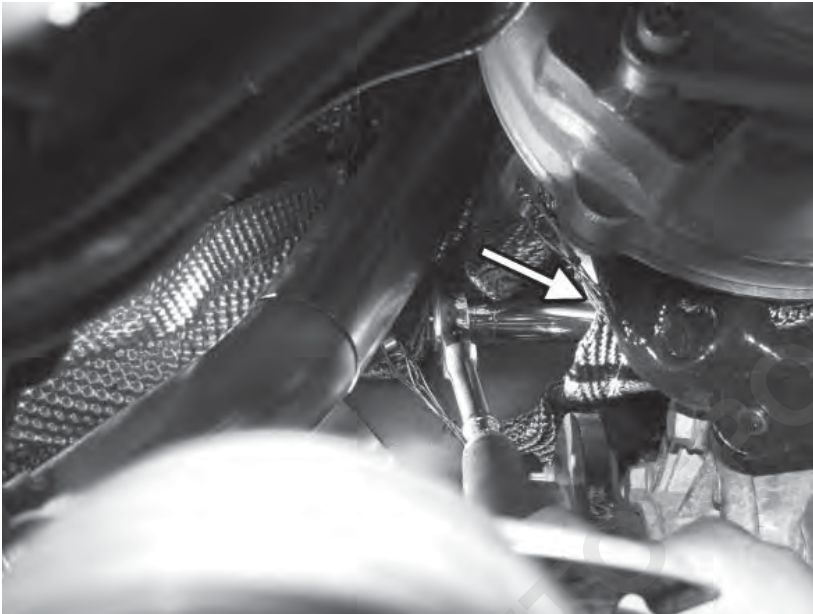

141) Tighten the downturn to turbo V-band clamp.

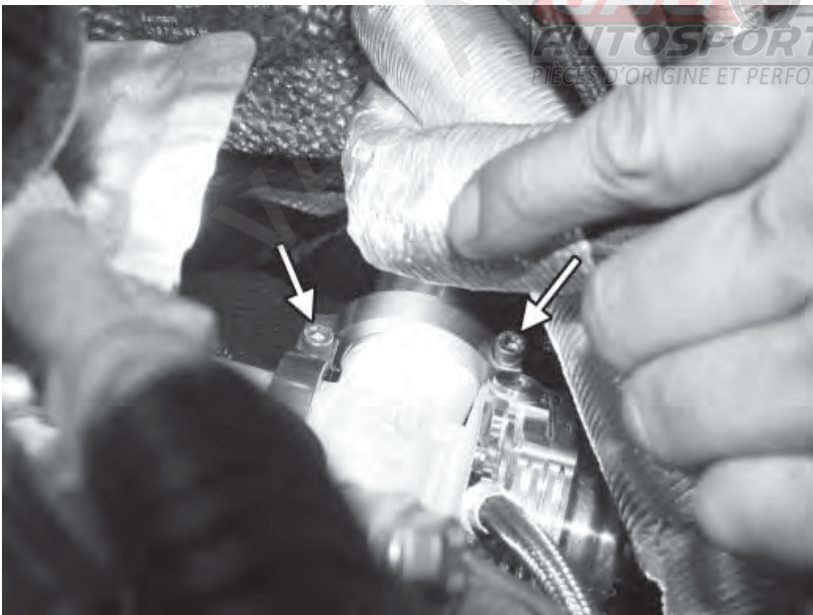

142) From the top side of the engine bay, tighten the two 3/16 allen screws holding the wastegate to downpipe, as well as the wastegate to manifold.

143) Install the second portion of the midpipe, and then install the catback portion of the exhaust following the instructions included with them.

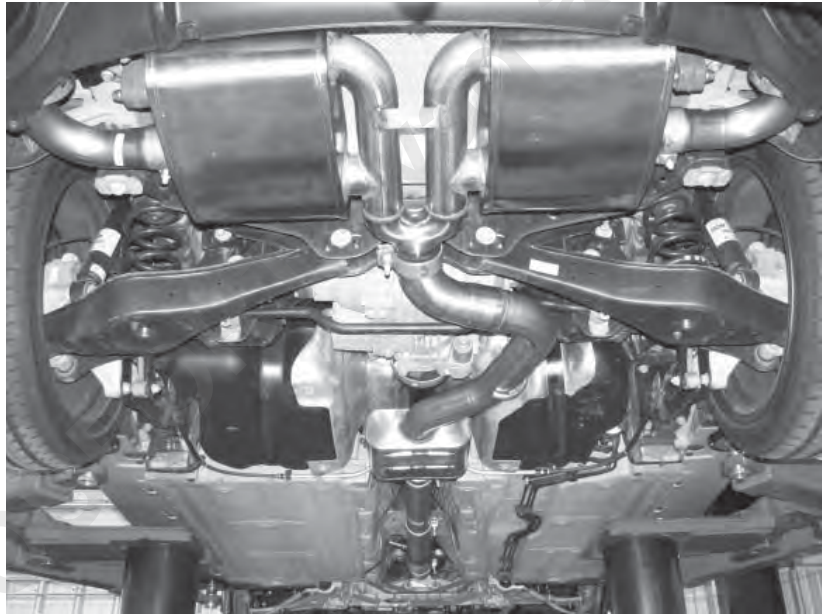

144) Remove the two T25 screws holding the coil pack cover in place. Unclip all five connectors on the coilpacks, and move the cover and coil pack wiring towards the front of the car.

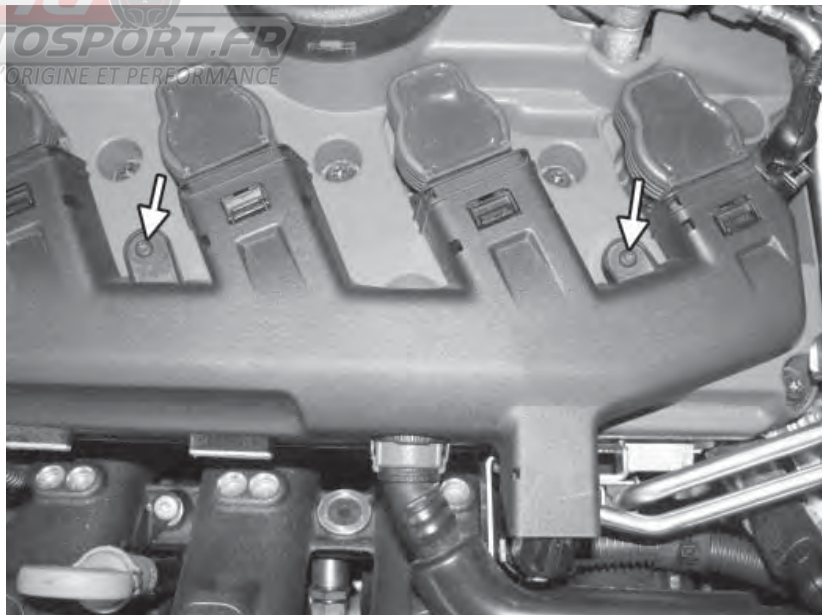

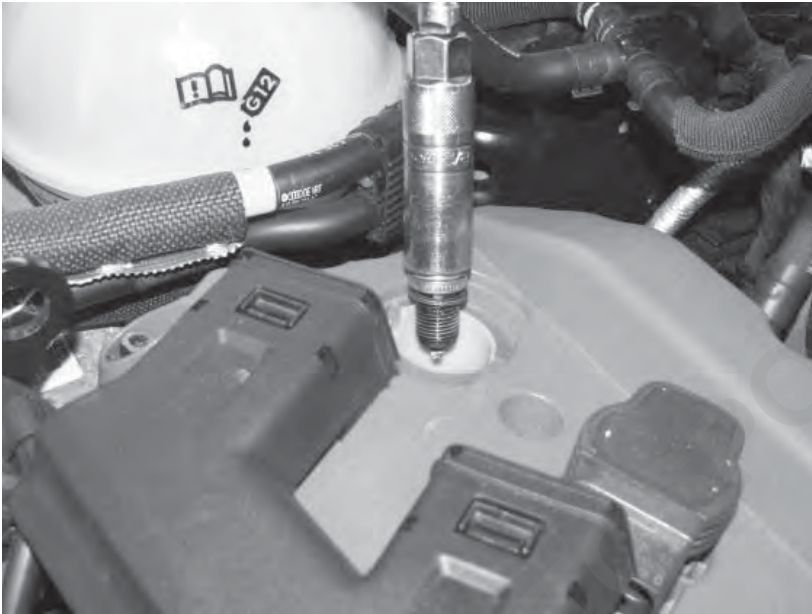

145) Remove the stock coil pack and spark plug. Gap the supplied APR spark plug to 0.024" (0.6mm). Install the APR spark plug and torque in place to 22lb-ft. Reinstall the coil packs, connect the electrical connectors, and put the two T25 screws back in place.

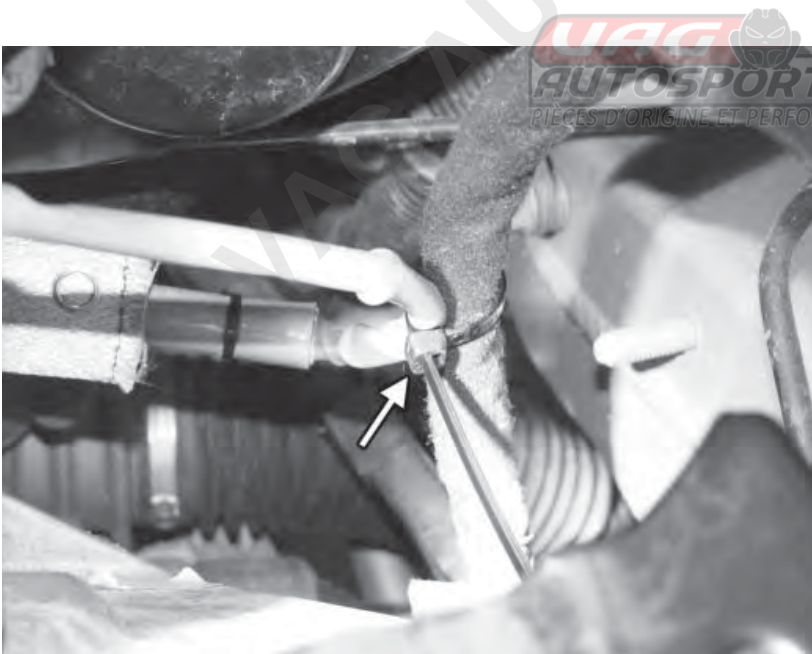

146) Pull the excess cable from the primary oxygen sensor over towards the left frame rail of the car, and secure it to the steering rack electrical harness with a ziptie.

147) Take two 10" sections of the velcro heat shielding and connect them together to make a wider piece. Wrap the stock heater hoses with the velcro heat shielding.

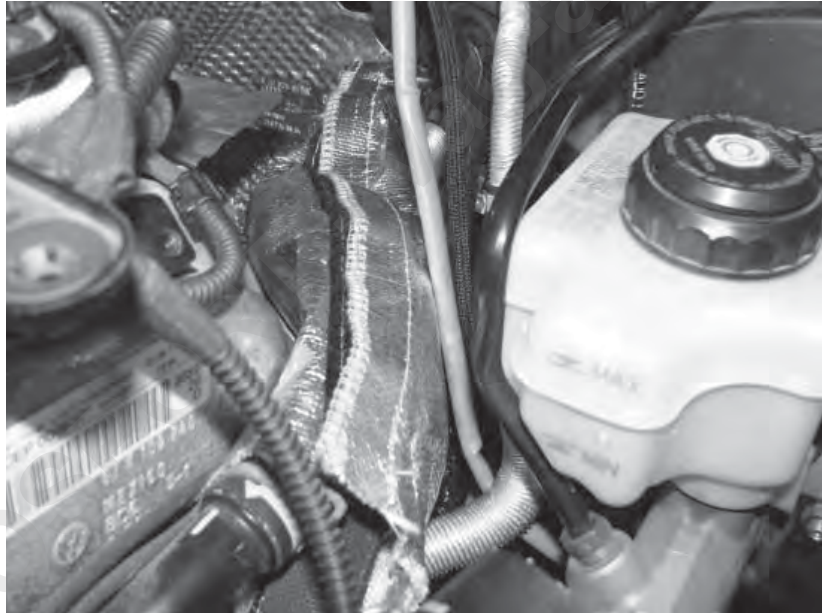

148) Open the factory airbox by loosening the eight T30 Torx screws. Remove the air straightener by unclipping the top of the straightener and lifting it out of the airbox lid.

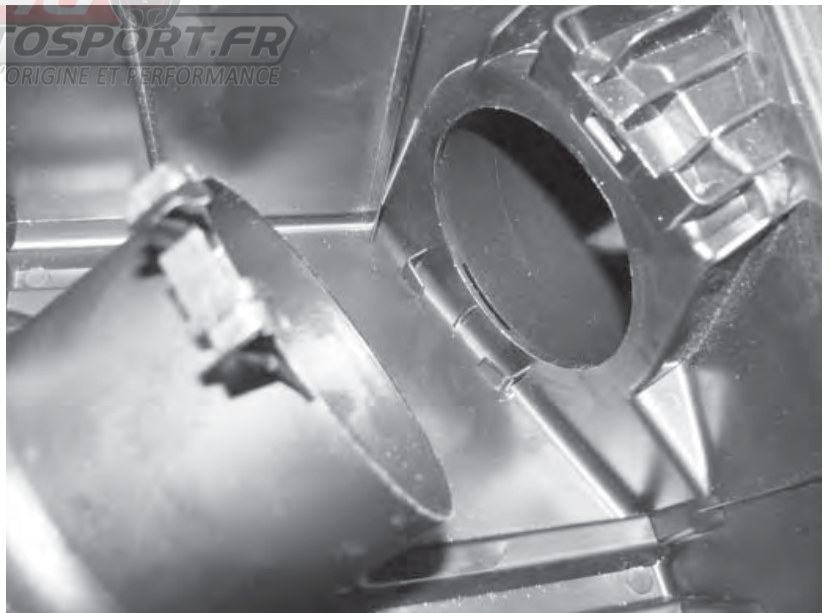



149) Apply some two part epoxy adhesive to the bottom tabs of the air straightener, and reinstall the straightener. Then, apply epoxy to permanently attach the straightener to the airbox lid. Also apply epoxy to the top clip of the straightener.

WARNING: The air straightener will come loose from the airbox if this step is skipped, and part of the straightener can be injected by the car, damaging the turbo, intercooler, and possibly engine.



150) Reinstall the airbox and intake assembly in the car, making sure the airbox snaps into the two factory mounting posts.

151) Connect the air intake pipe to the compressor inlet pipe coupling and attach the original spring clamp. Also install the two T30 Torx screws connecting the inlet pipe to the bracket on the back of the engine.

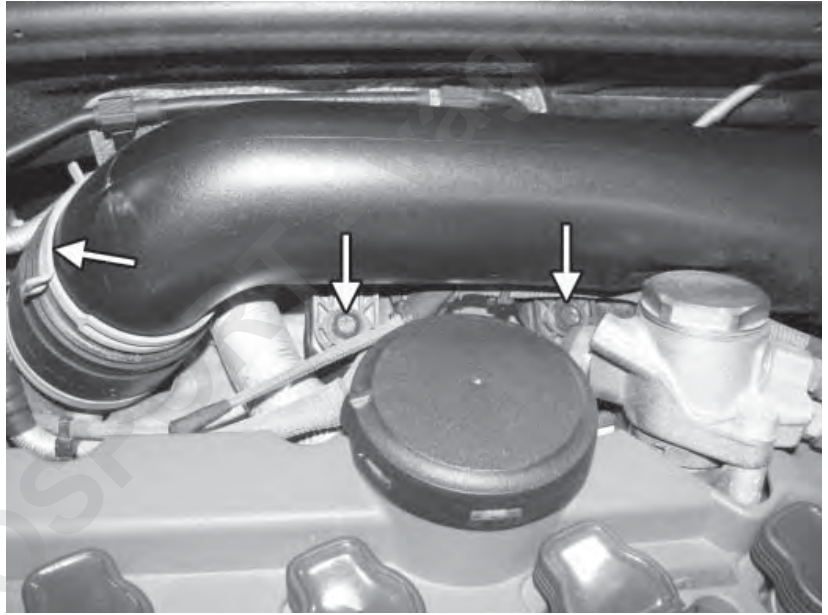

152) Reconnect the recirculation valve hose and attach it with the original spring clamp.



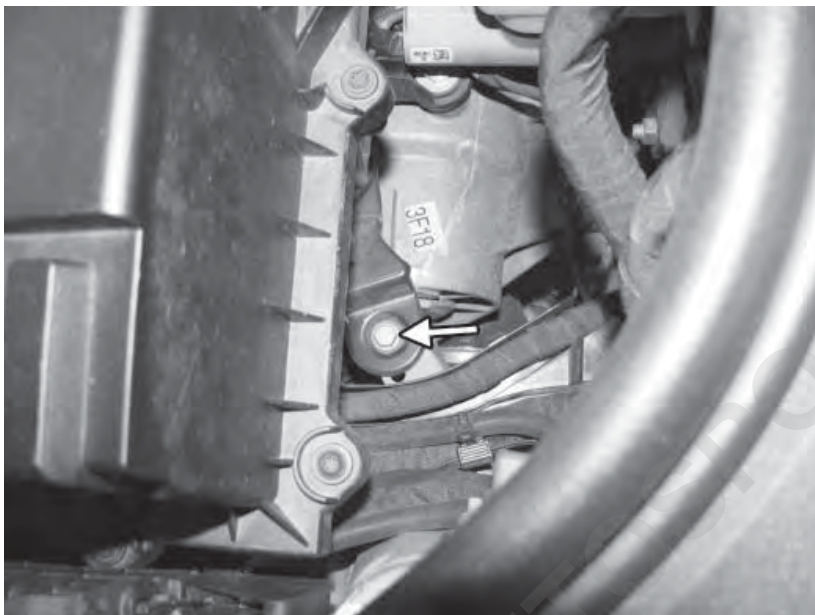

153) Install the 10mm bolt into the back of the stock airbox.

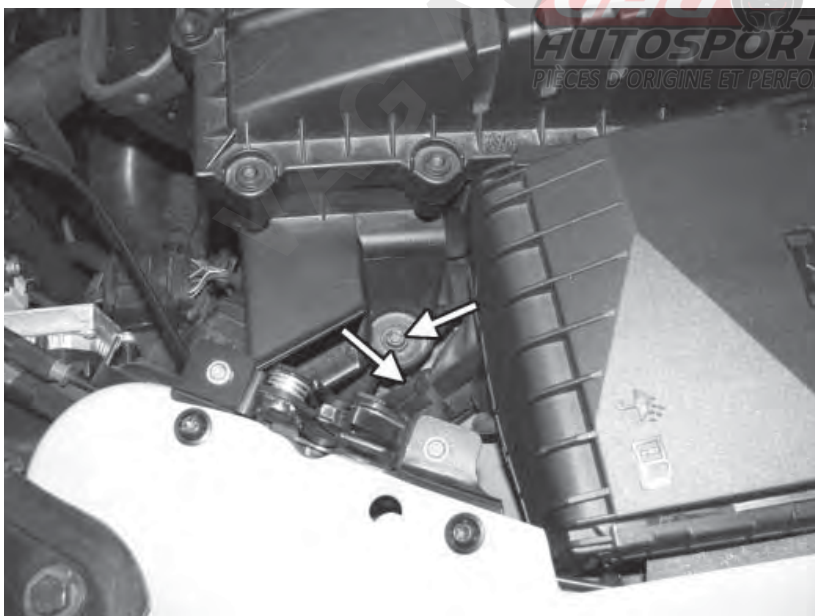

154) Install the 5mm allen screw into the side of the stock airbox. Install the 10mm bolt into the airbox mounting bracket.

155) Reconnect the airbox inlet coupler to the airbox and to the radiator core support, making sure the four tabs lock in place.

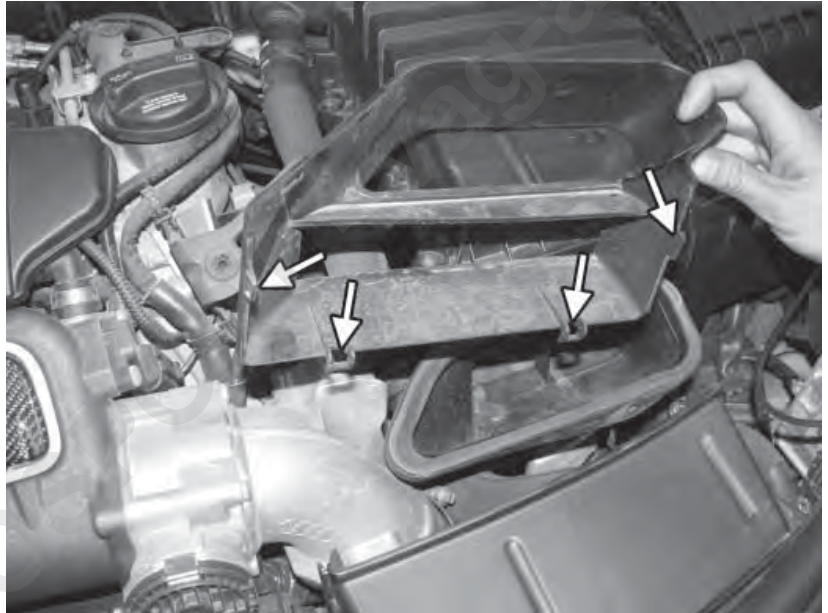

156) Install the airbox inlet lid, making sure the two clips snap in place.

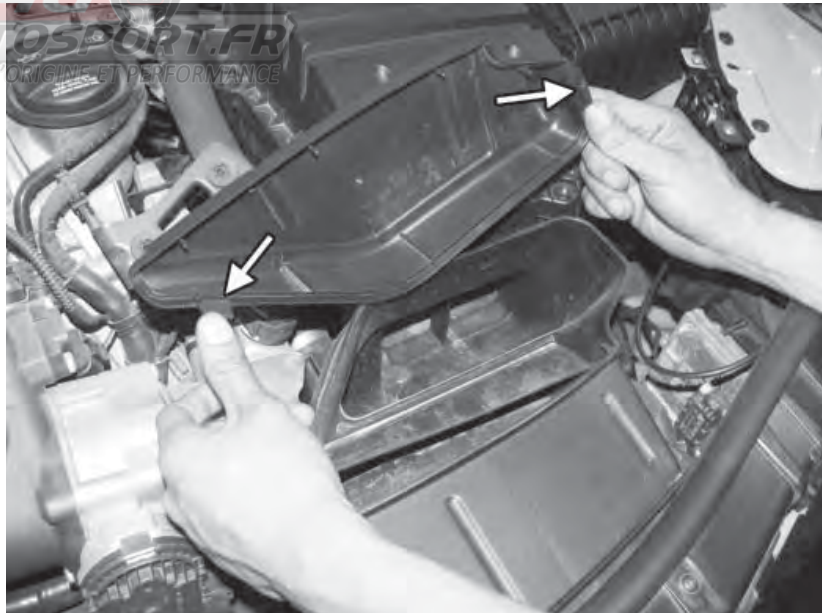

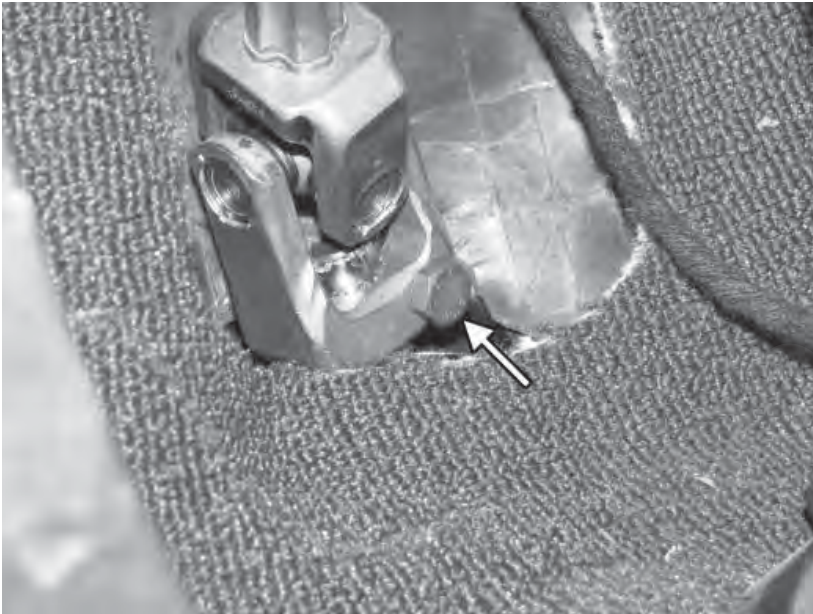

157) Making sure the steering linkage is splined into the steering rack, reinstall the 13mm bolt in the linkage and torque to 15lb-ft, then tighten an additional 90°.

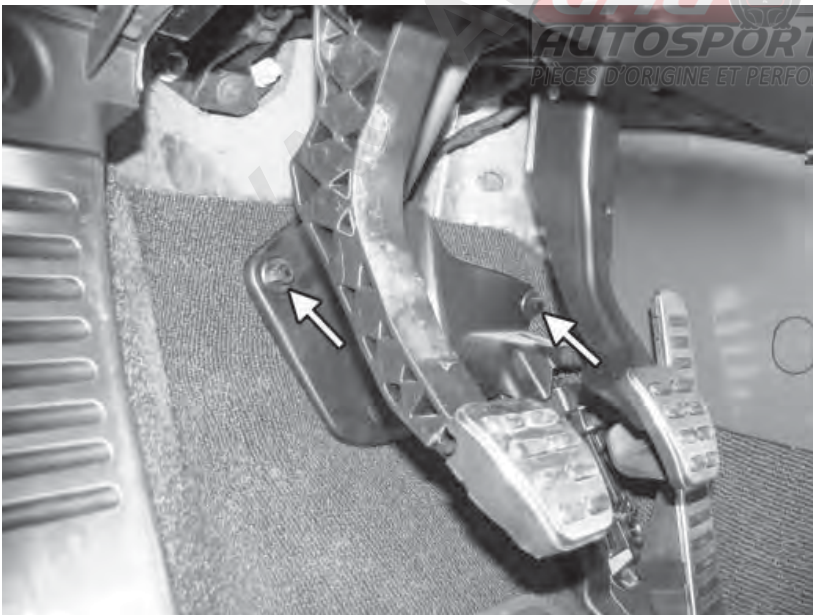

158) Install the steering linkage cover and reinstall the two 10mm bolts.

159) Reinstall the right side axle in the car. Install the two 21mm nuts on the tie rod end links and tighten to 15lb-ft, and then tighten an additional 90°. Reconnect the two electrical connectors on the ride height sensors. Finally, loosely install the two 24mm 12-point axle bolts with ribs into either side of the car.

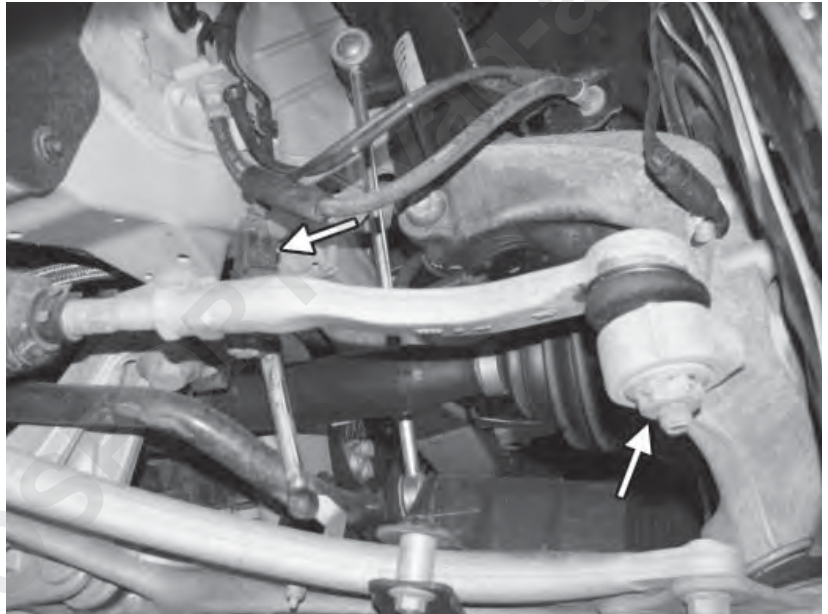

160) Install the six (three on either side) 16mm nuts holding the lower control arms to the uprights and tighten to 15lb-ft, and then tighten an additional 90°. Install the 18mm nuts on both sides to connect the sway bar end links to the sway bars and tighten to 48lb-ft.

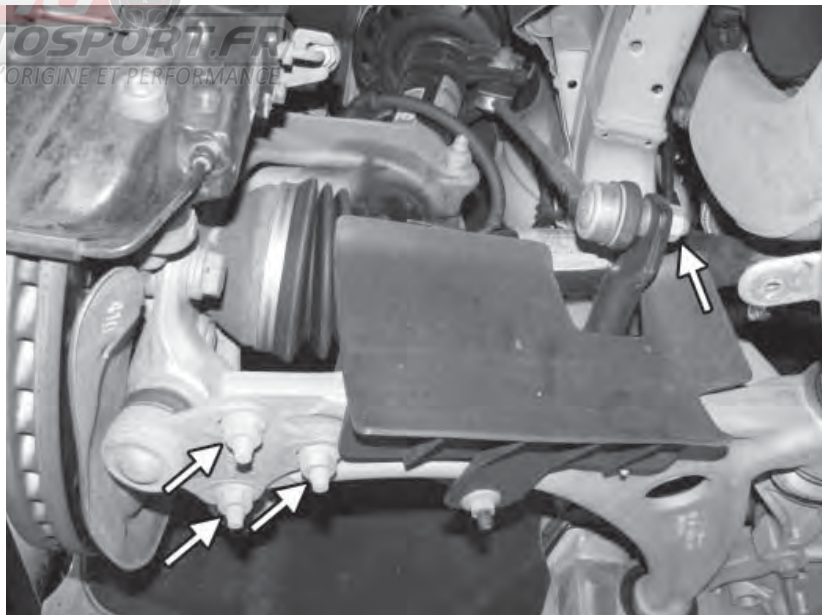

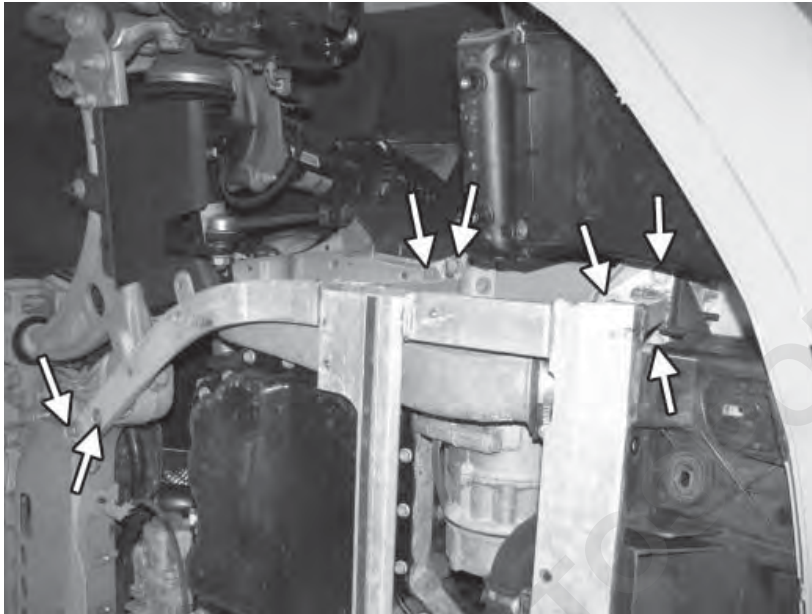

161) Install the belly pan mounting frame with the fourteen 13mm bolts.

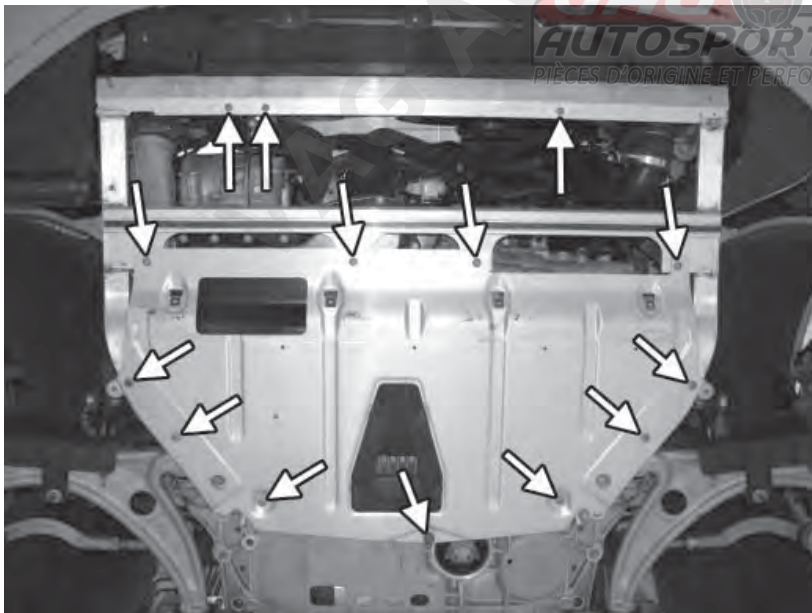

162) Install the rear metal belly pan using the one 8mm triple square bolt and the ten T30 Torx screws. Reinstall the three T30 Torx screws on the front of the belly pan mounting frame.

163) Install the five T30 Torx screws that connect the bottom of the radiator core support to the belly pan mounting frame.

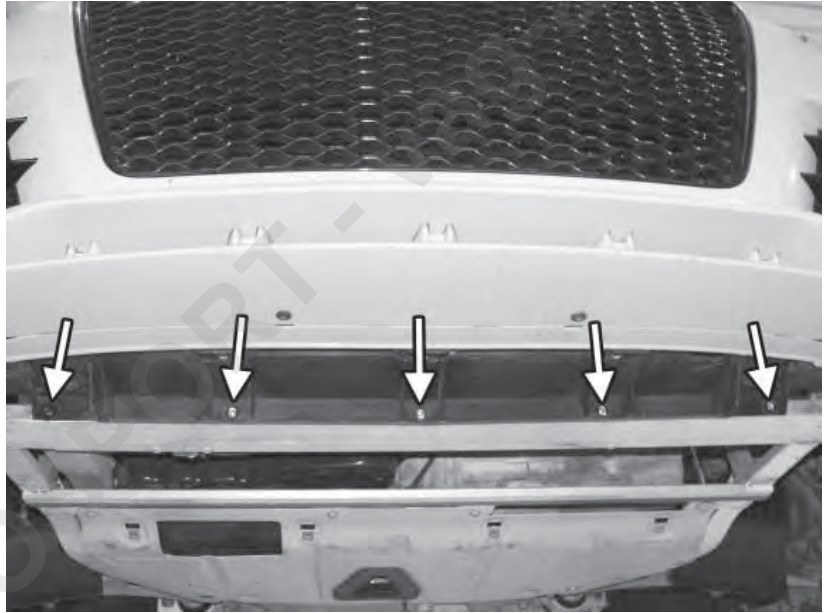

164) Install the three T30 Torx screws and the two 10mm bolts that hold the side radiator mount to the car.

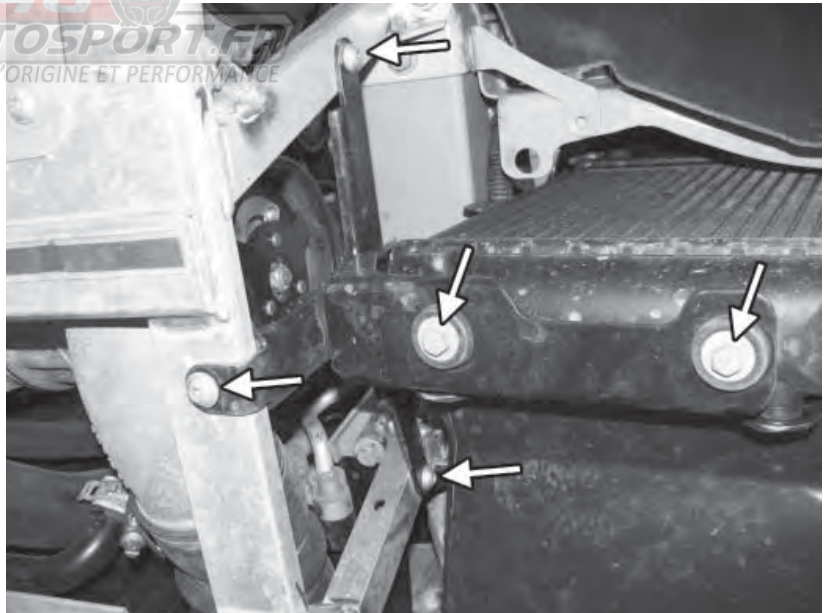

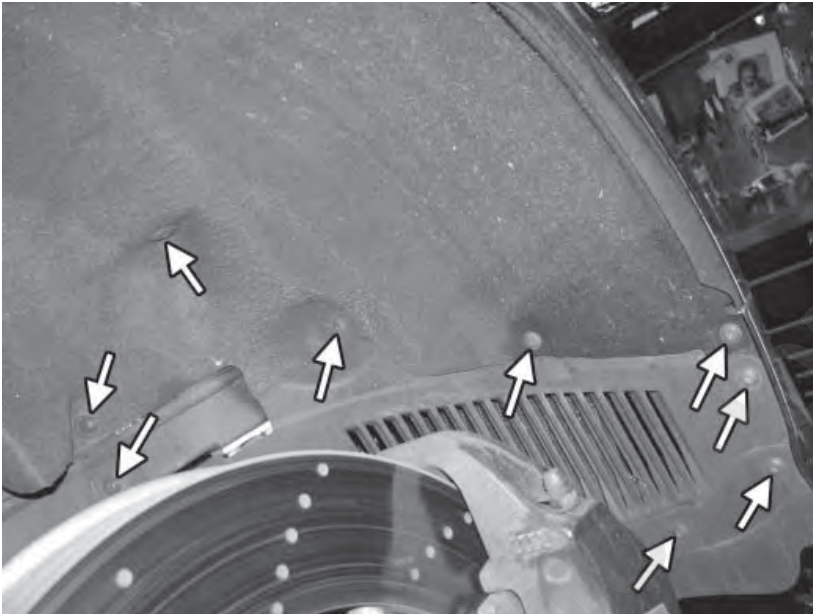

165) Install, from left to right, the two 10mm nuts, the one pushpin plastic fastener, and the six T25 screws in the inner fender liner.

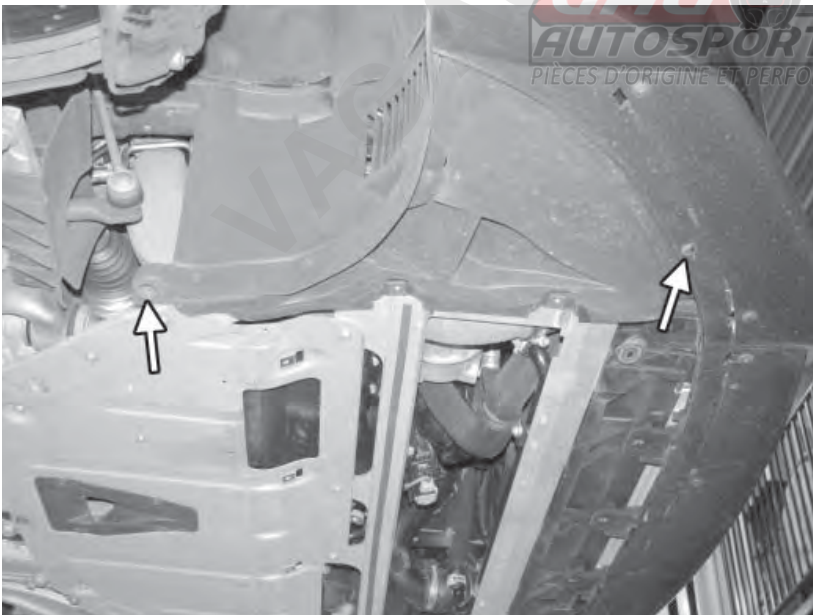

166) Install the front portion of the lower fender liner with the one T25 and one T30 Torx screws.

167) Install the front plastic belly pan with the fifteen T25 Torx screws.

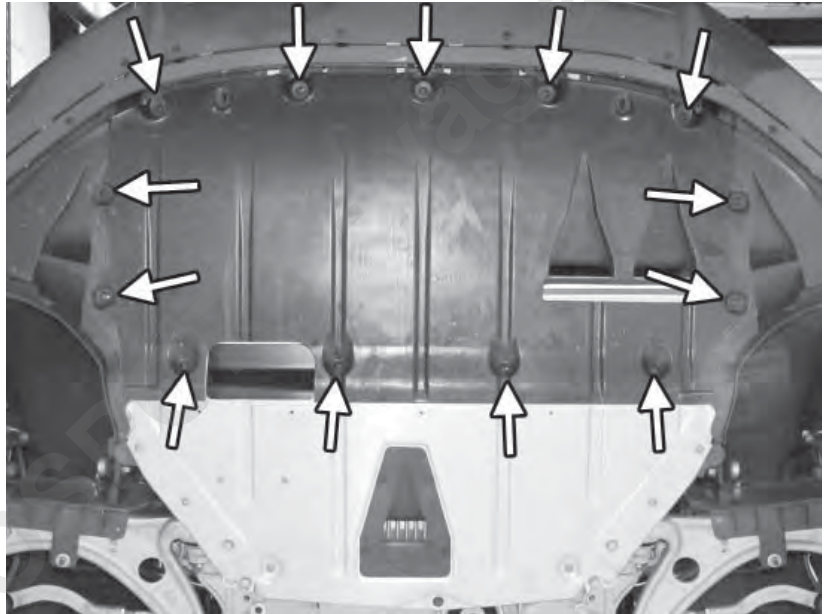

168) Remove the front center cap and then reinstall the front wheels. Lower the car to the ground and torque the 17mm lug bolts to 89lb-ft. Finally, tighten the 24mm axle bolt to 52lb-ft. Then tighten the bolt an additional 90°.



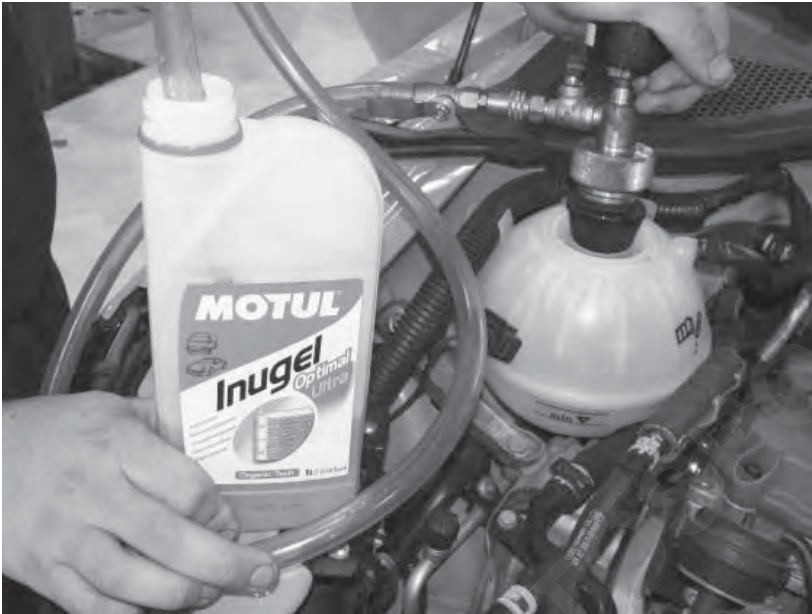

169) Using a vacuum bleeder, fill the coolant system with engine coolant.



170) After changing the engine oil filter, fill the engine to the correct level with oil.

171) Reconnect the positive terminal of the battery by tightening the 10mm bolt, and then reinstalling the trim cover on the battery.

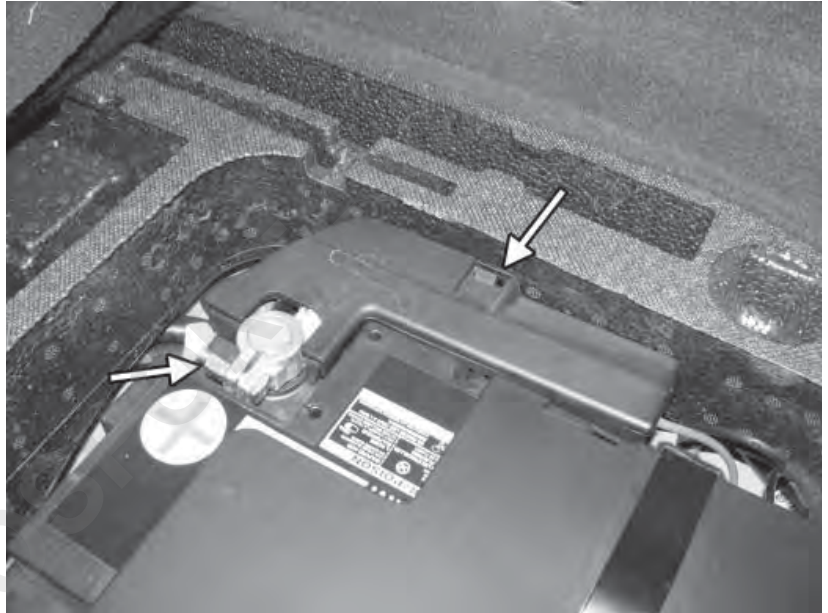

172) Remove the spark plugs again and crank the engine three times for approximately 15 seconds each time to prime the engine and turbo with oil.

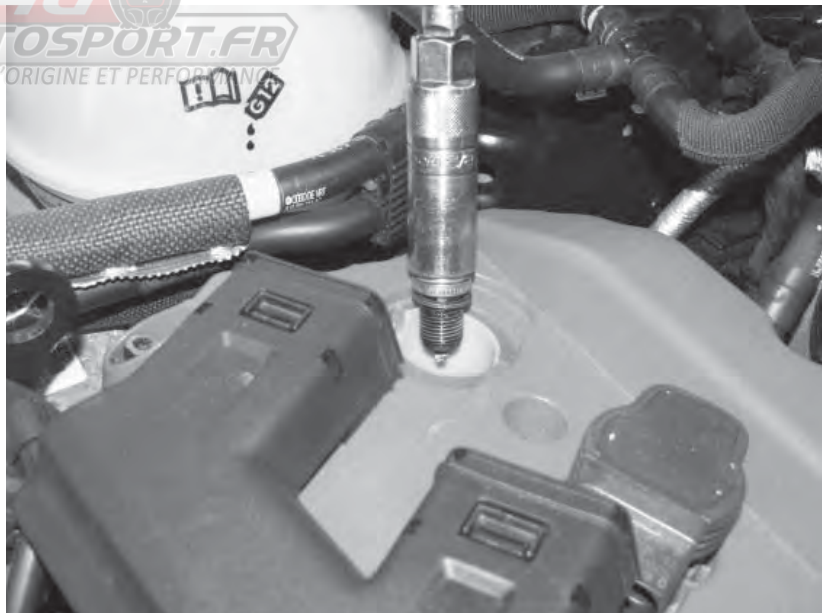



173) Start the vehicle and move it outside to a well ventilated area. Let the car warm up very slowly the first time, so as to break in the turbo blanket. The blanket will smoke very heavily for the first several times the car is run. Do NOT drive the car very hard until the smoke has subsided some. Keep an eye on the blanket to make sure it is just smoking, and is not on fire. It is normal for the blanket to continue to smoke for several heat cycles of the engine.



NOW WAIT BEFORE DRIVING AND READ THIS!!

CONGRATULATIONS!

You just successfully installed your Stage III kit on your already great 2.5T. This kit completely transforms the car in more ways than you can imagine. Don't take your car out and drive it hard without first getting used to the new power. It would suck to have just spent all the time, money, and frustration you did on your car to go out and wreck it!! Here is what we advise for your first drive...

Get a friend who knows something about cars to go for the first drive with you. Grab your wallet (with some cash in it), your cell phone, and some basic tools in case you have a problem with that hose clamp or bolt that you forgot to tighten. Get all the extra boxes and junk you have in the back of your car out so they don't go flying around. Get in your car and **PUT ON YOUR SEAT BELT!**

Make sure your engine is fully up to temperature before going for a drive. Try not to pull out in traffic so you can have some time to react if something happens to your car. Use light throttle inputs and be easy on the car. As you start to drive you will hear some of the new noises it makes. It will take you some time to distinguish between what sounds normal and what is a problem. Don't worry too much for now about all of the air rushing noises that you hear, but make sure that you don't hear anything rattling or hitting things that they should not be hitting.

Gradually build up to driving your car with its newfound power. Soon, you will hear a new hissing sound, which is the sound of your tires spinning in second and third gear. Be careful about how much power you use in lower gears. Do not add too much power when in a turn, only when the car is pointed straight. You will get more comfortable with this power as time goes by...

Before you realize it, your brakes will not be working like they used to. They faded away when you made that stop after the third gear run. Go home now and don't try to get a ticket from racing that Corvette you saw heading the other way. Welcome to the next level. Welcome to Stage III.

VAG AUTOSPORT - vag-auto



APR, LLC

4800 US HWY 280 West Opelika, AL 36801

+1.334.502.5181

www.goapr.com

VAG AUTOSPORT - vag-auto



TTRS
2.2TFSI

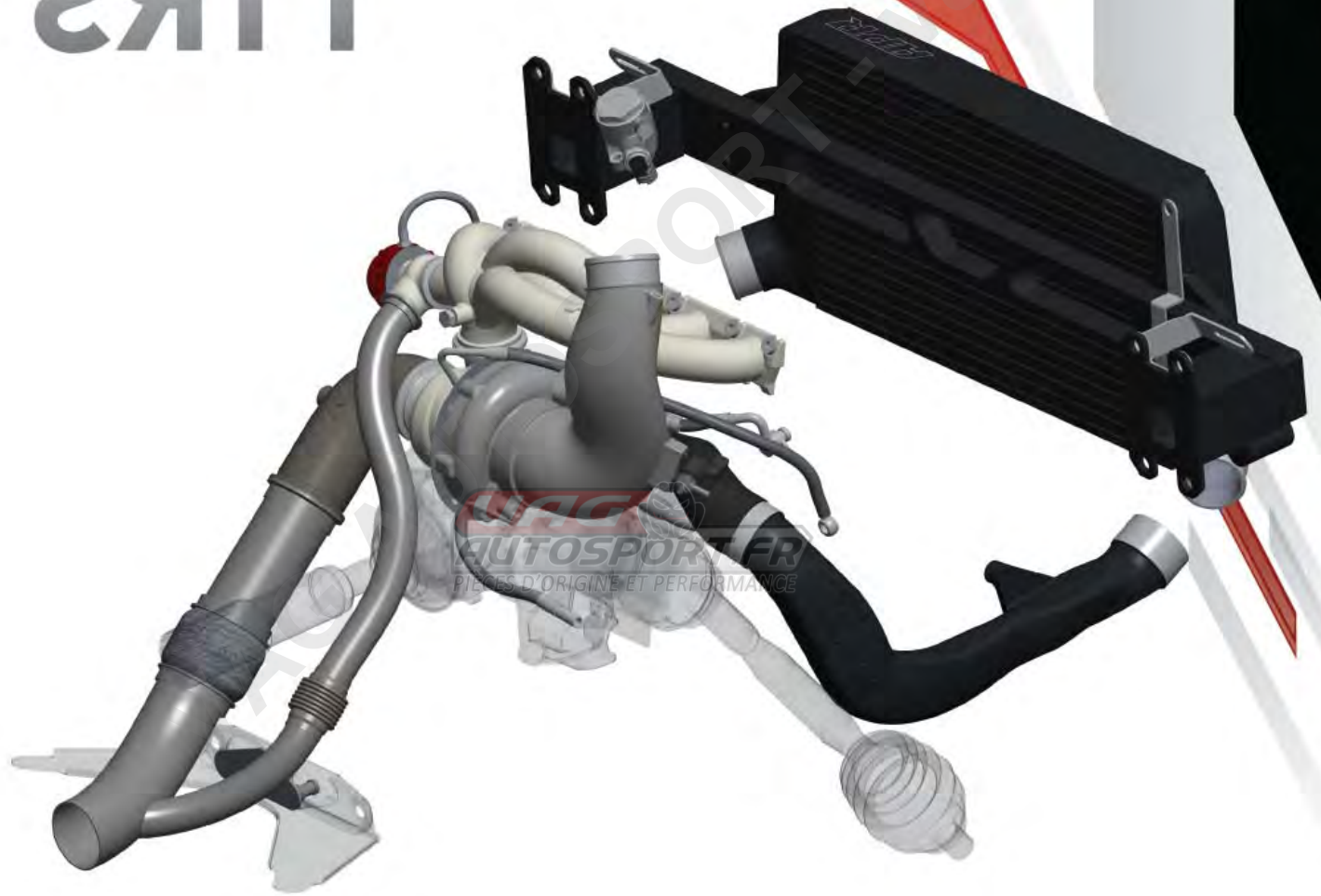

APR
AUTOSPORT FR
PIÈCES D'ORIGINE ET PERFORMANCE

APR

TTRS 2 STAGE 3 TURBO KIT / INSTALLATION INSTRUCTIONS