

#TL100116

CI100038

APR 2.5T MQB Inlet Pipe



INSTALLATION MANUAL

APR



VAG AUTOSPORT



Notes:

These instructions were written for a North American-specification TT-RS. Other vehicles, like the RS3, are similar.

When disassembling the car, be sure to keep all fasteners so they can be reused. It is recommended that you get some kind of compartmented tray to organize the fasteners, such as a fishing tackle box or several large ice cube trays. Fasteners that are not reused for reinstallation are noted in the instructions. All directions used in this manual (right, left, front, etc.) are based on if you were sitting in the driver's seat of the car.

These instructions assume that you have basic mechanical skills and several varieties of basic hand tools in order to install the kit. If you have any questions about the install, feel free to contact your APR representative.



WWW.GOAPR.COM

4800 US HWY 280 West Opelika Alabama 36801

TL100116



1) Securely lift the car using an auto lift or a jack and jackstands, then remove the engine cover.

APR

2) Remove the stock intake tube by first removing the hose clamp between the accordion hose and the airbox. Then disconnect the Norma style fitting from the crankcase solenoid valve (N546). Remove the spring clamp from the intake to the stock compressor inlet pipe. Finally, on the back side of the intake tube, remove the T30 screw holding the tube to the cylinder head and remove the intake tube with the accordion hose.



TL100116

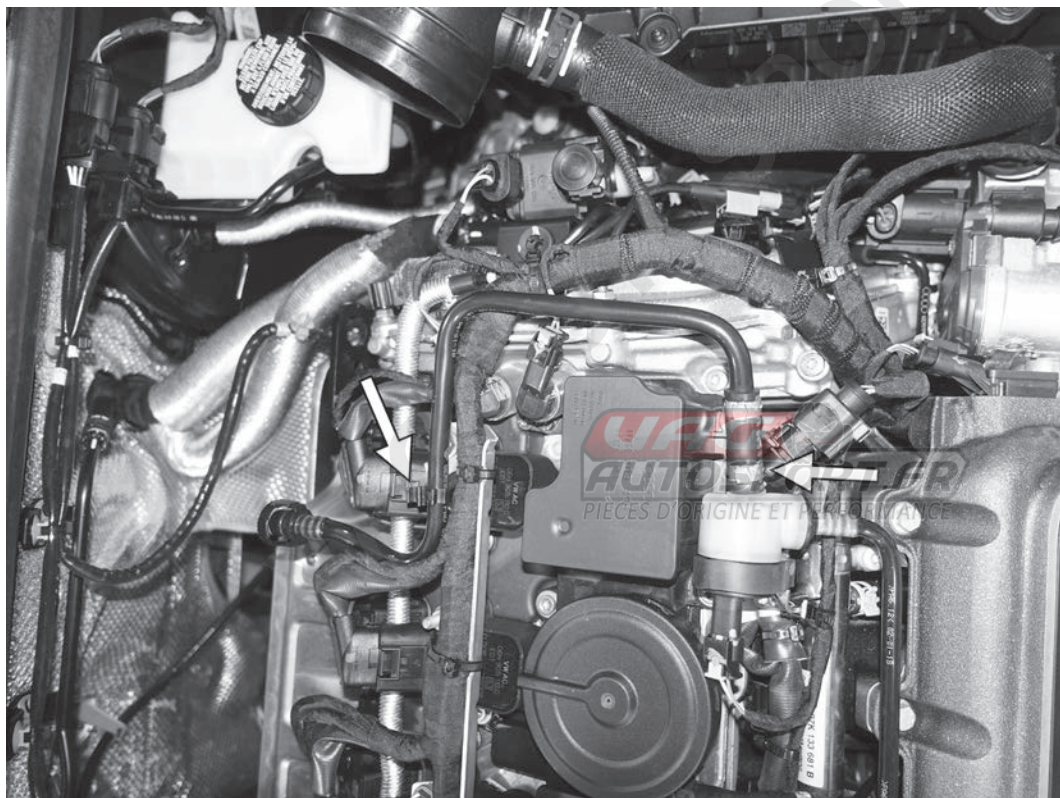

3) Cut the ear clamp on the rubber hose at the crankcase solenoid valve (N546) and separate the hose from the valve. Remove the clip on the back side of the plastic hose and remove the hose from the car.

4) Locate the vacuum line that is connected to the side of the turbo-charger wastegate. Follow the line up to the back side of the turbo inlet pipe and remove the T30 screw holding the hard line to the turbo inlet pipe.

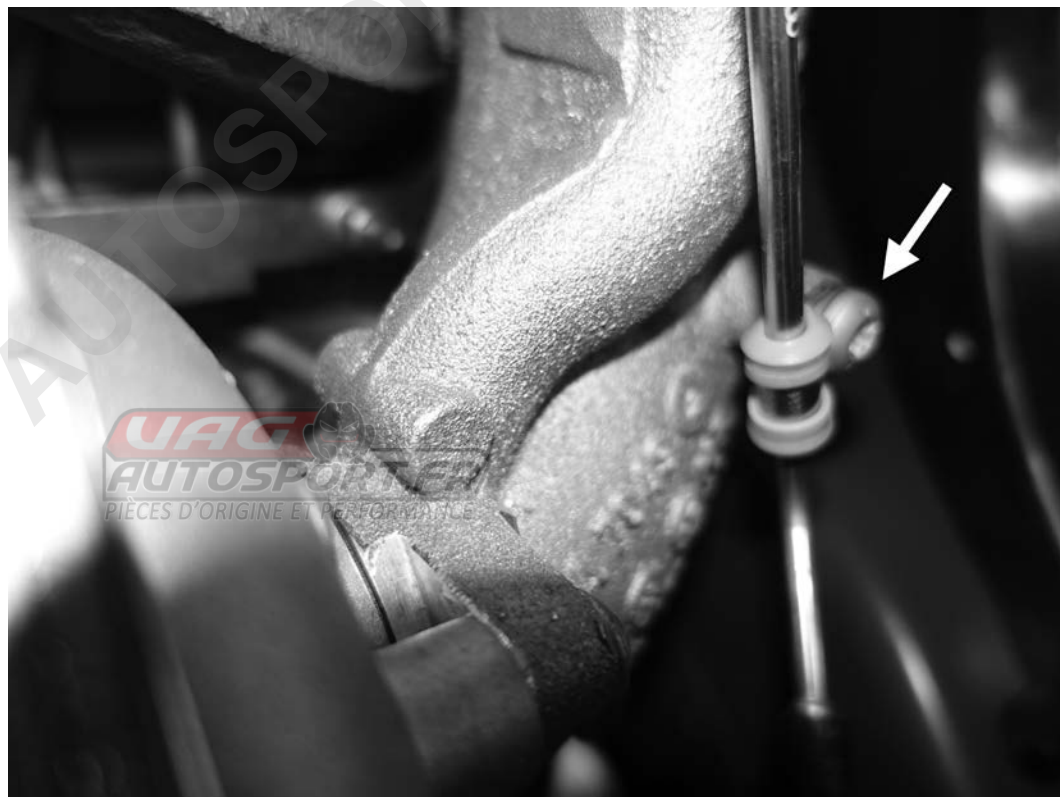

TL100116

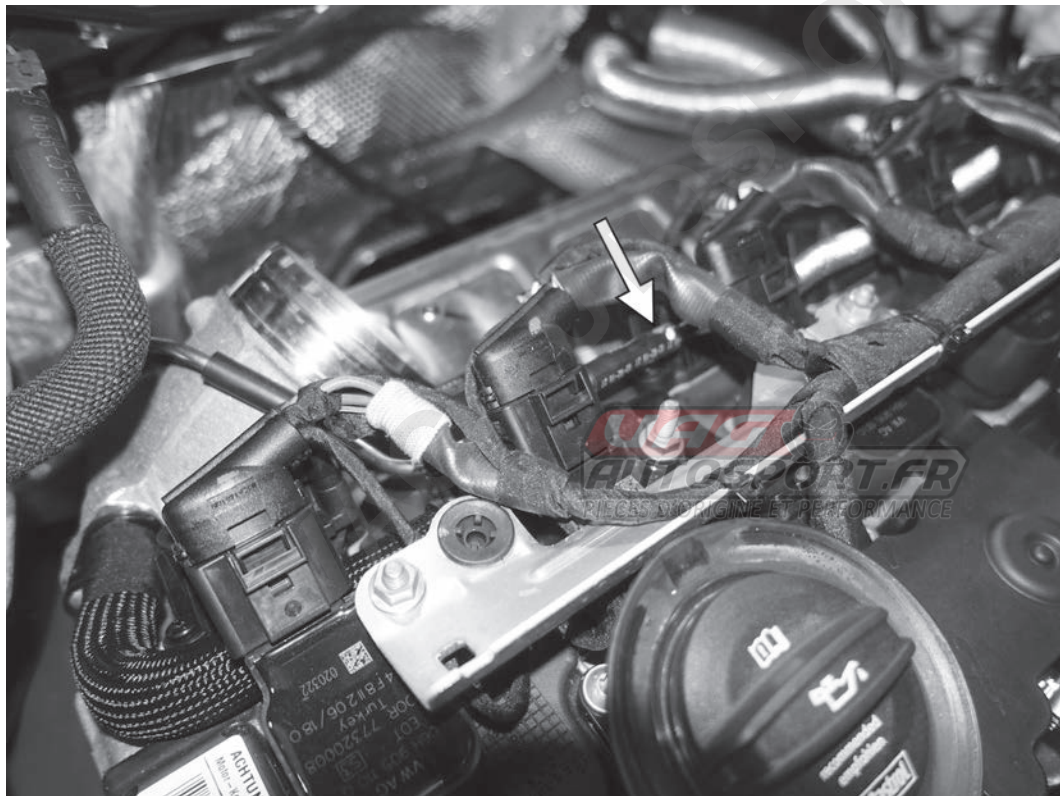

5) Follow this hard line up until it goes to a rubber line, and then back to a hard plastic line, roughly behind the cylinder #3 ignition coil. Disconnect the rubber hose from the plastic line and remove the entire hose assembly from that point to where it attaches to the wastegate, on the back of the turbocharger.

6) Remove the three 10mm nuts holding the bracket across the top of the ignition coil packs. Carefully lift the bracket up and away from the back side of the coil packs.

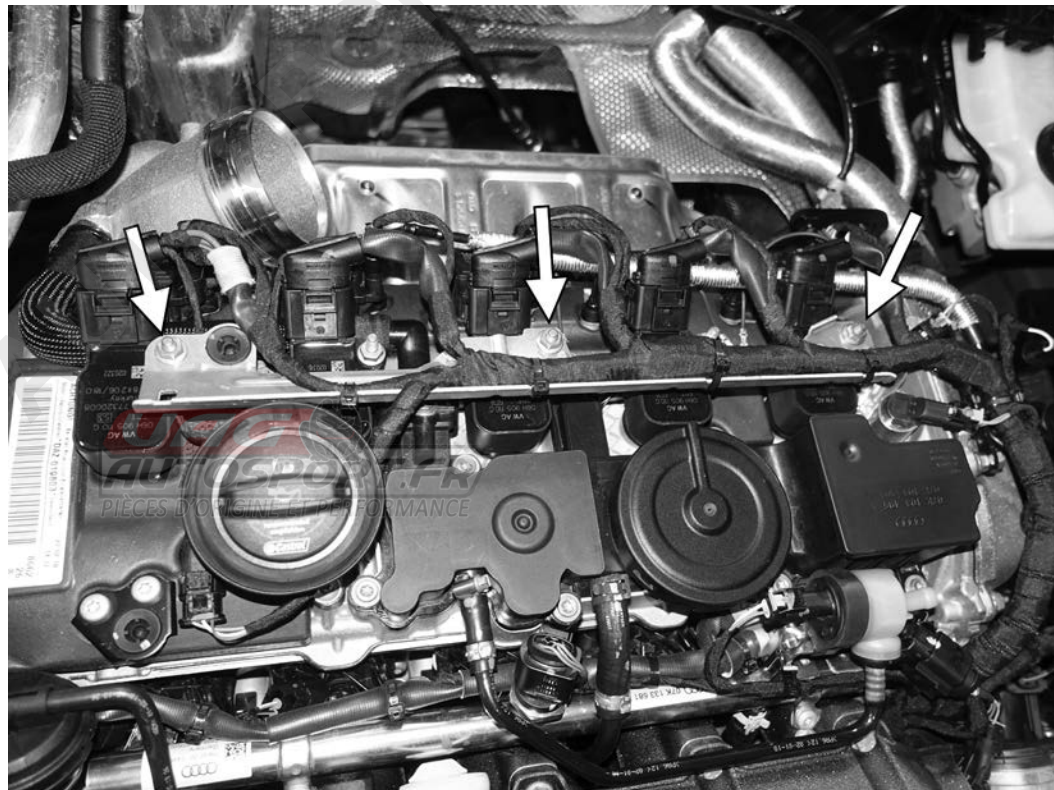

TL100116

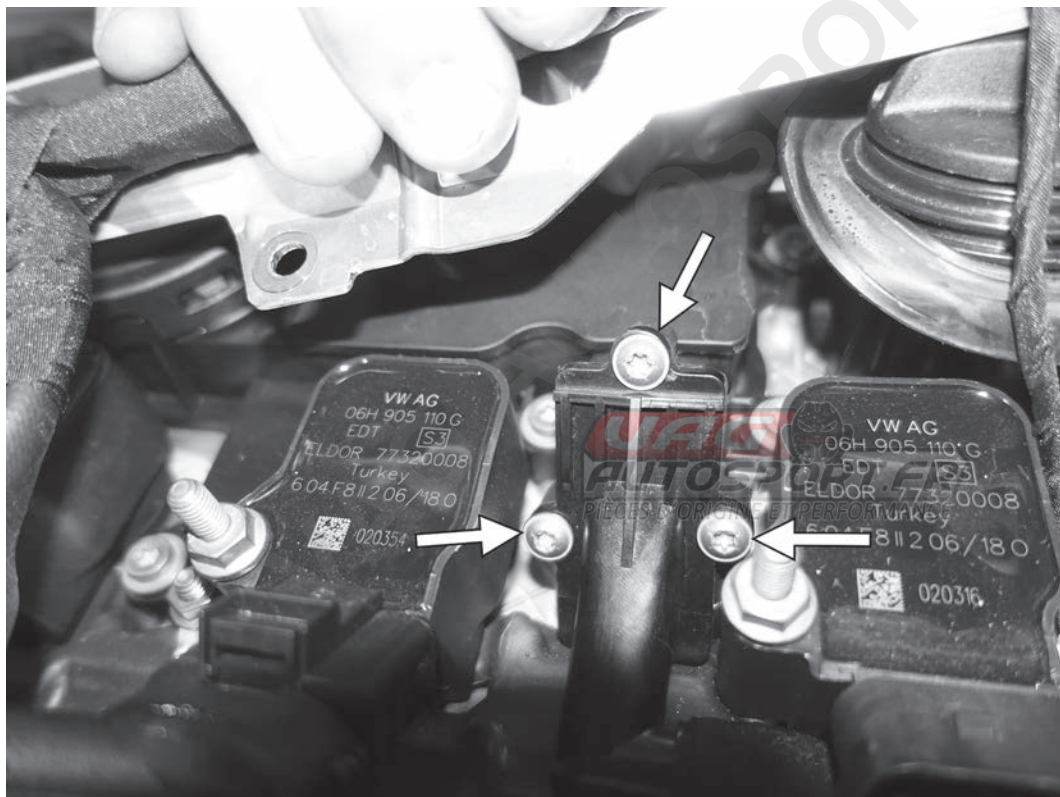

7) Locate and remove the three T20 screws that hold the PCV vent line to the PCV valve, between ignition coils #1 and #2.

8) Disconnect the electrical connectors to the #1 and #2 ignition coils.

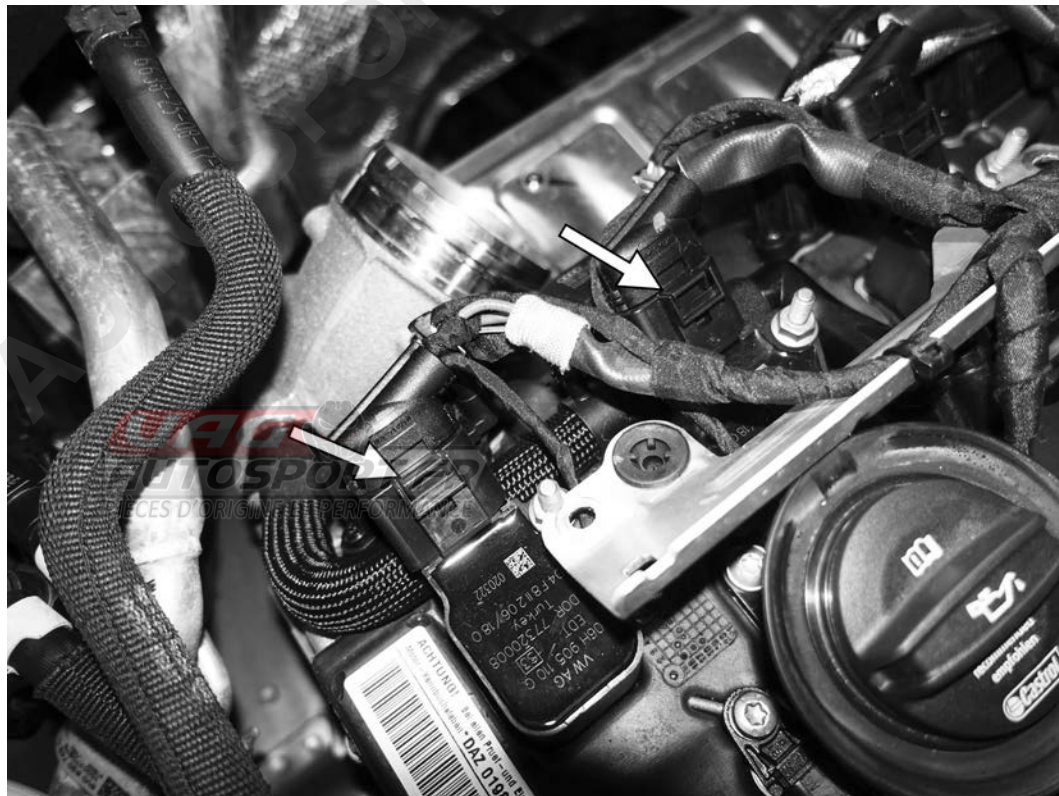

TL100116

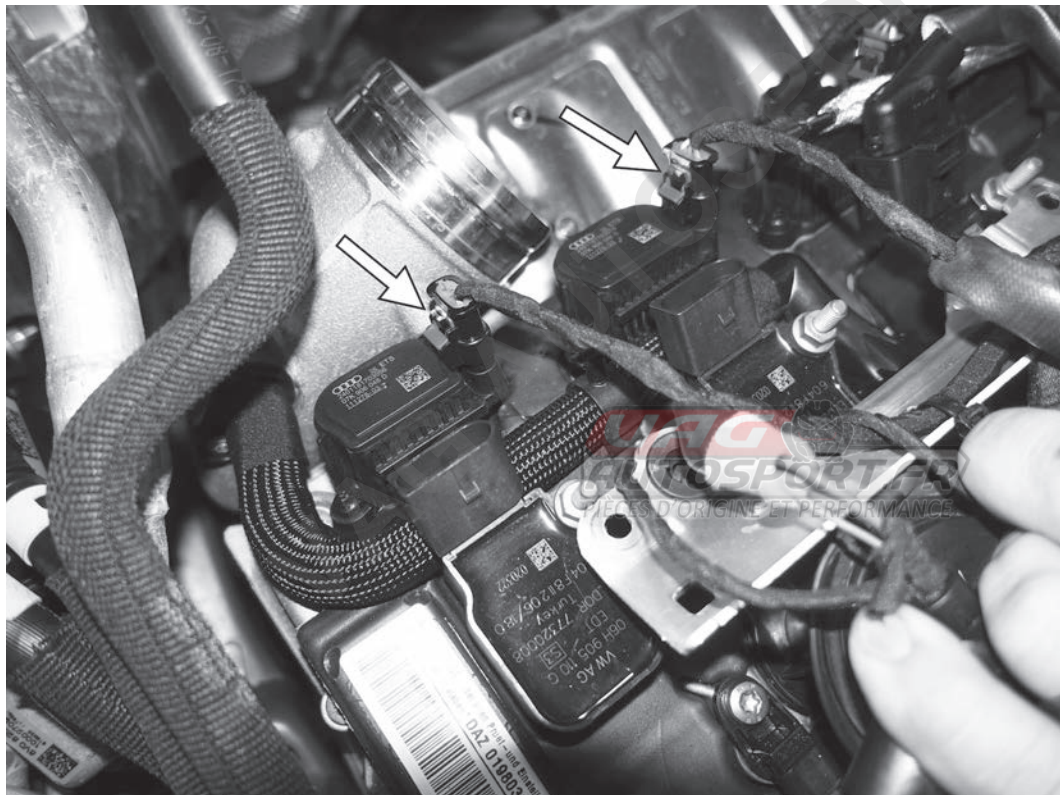

9) Disconnect the electrical connectors to the two exhaust valvelift solenoids, just under the ignition coil connectors.

10) Slide PCV vent hose from the back of the PCV valve and from underneath the ignition coils. Leave the hose attached to the stock turbo inlet pipe.

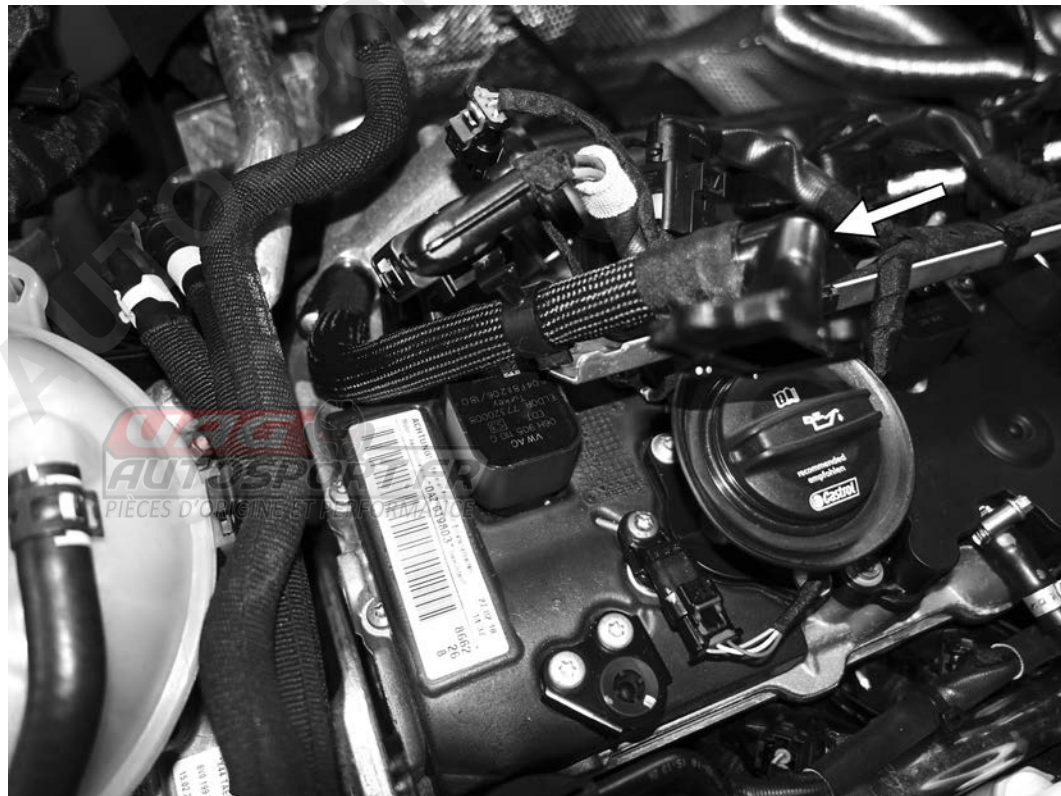

TL100116

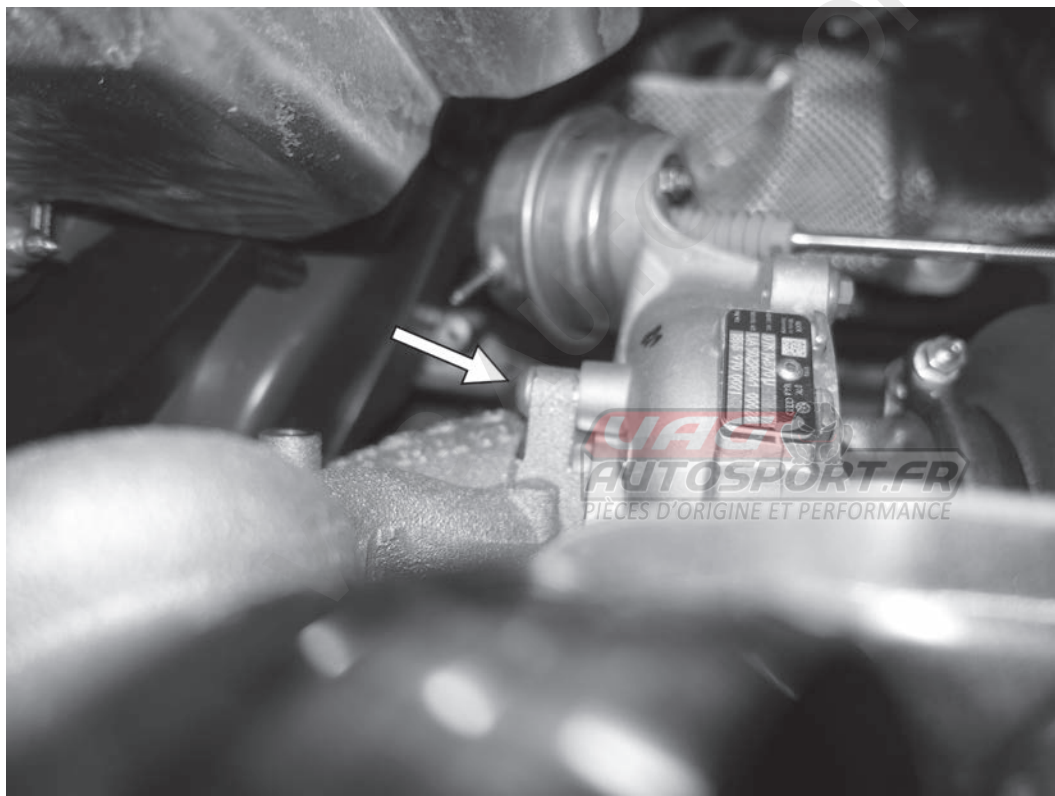

11) Locate the top T30 screw holding the upper side of the turbo inlet pipe to the compressor side of the turbocharger. Remove this screw, leaving the lower one in place.

12) Remove the ten T25 screws holding the front of the belly pan in place.

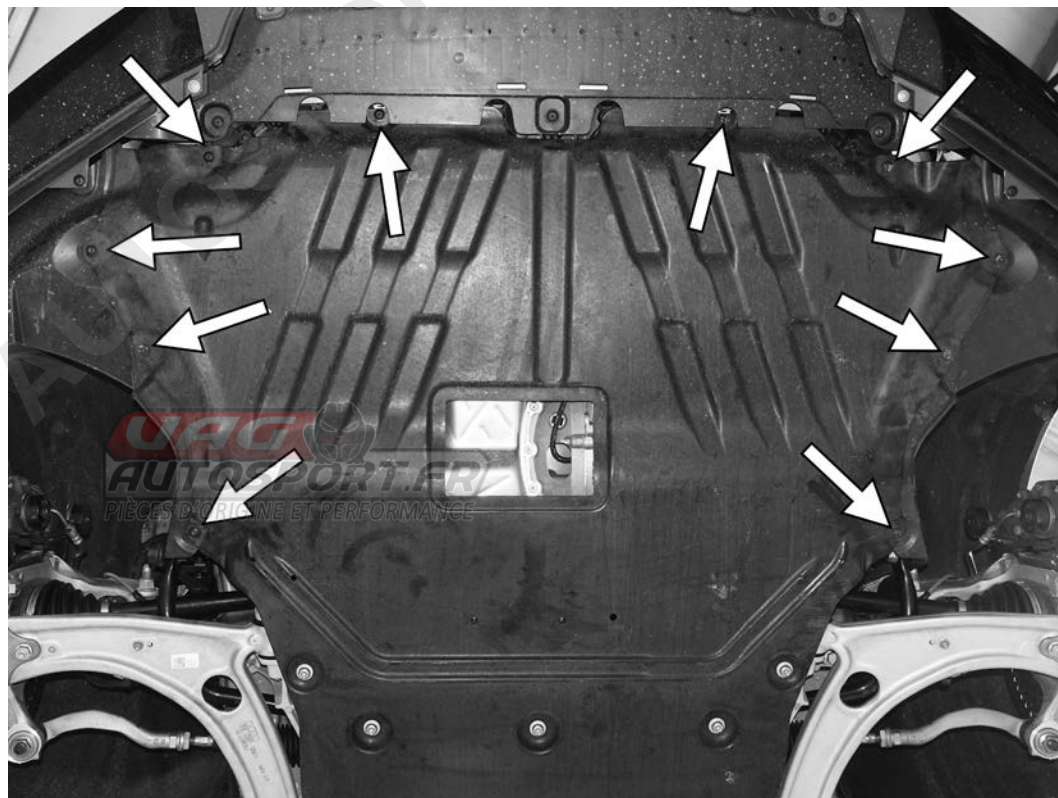

TL100116

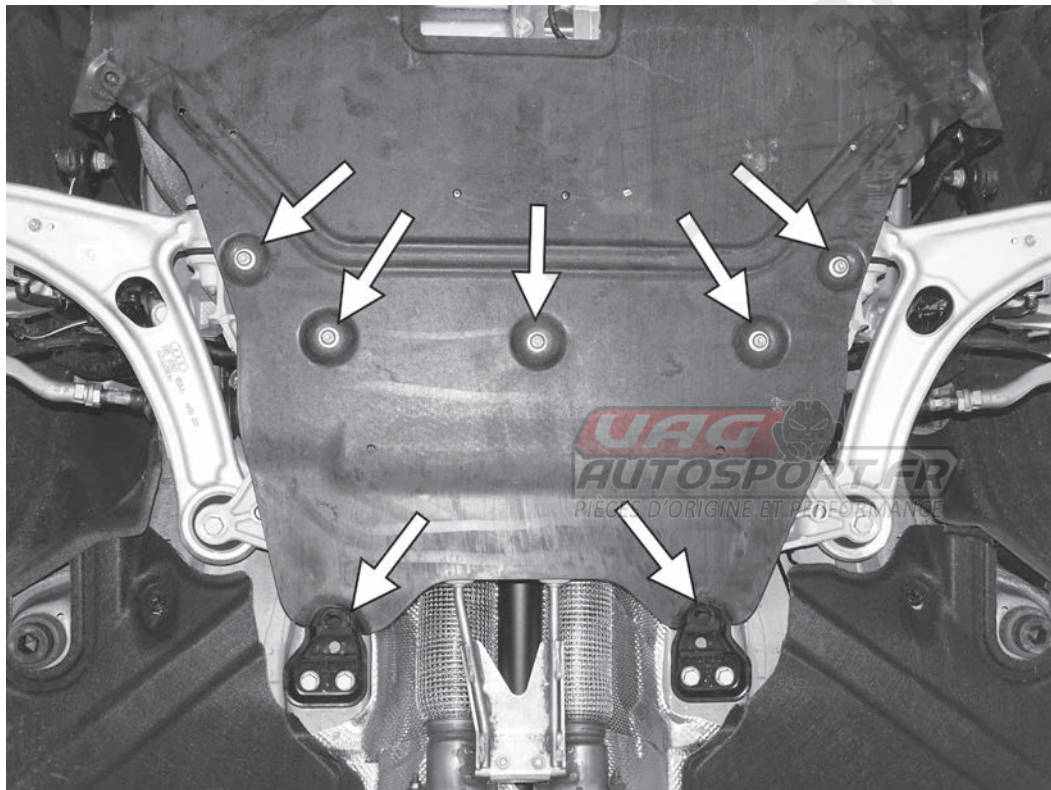

13) Remove the two push pin style connectors from the back of the belly pan. With an assistant holding the belly pan, remove the five T45 screws in the middle of the belly pan, and remove the it from the car.

14) Remove the two 8mm allen nuts holding the right axle heat shield to the transmission bevel box, and remove the heat shield from the car.

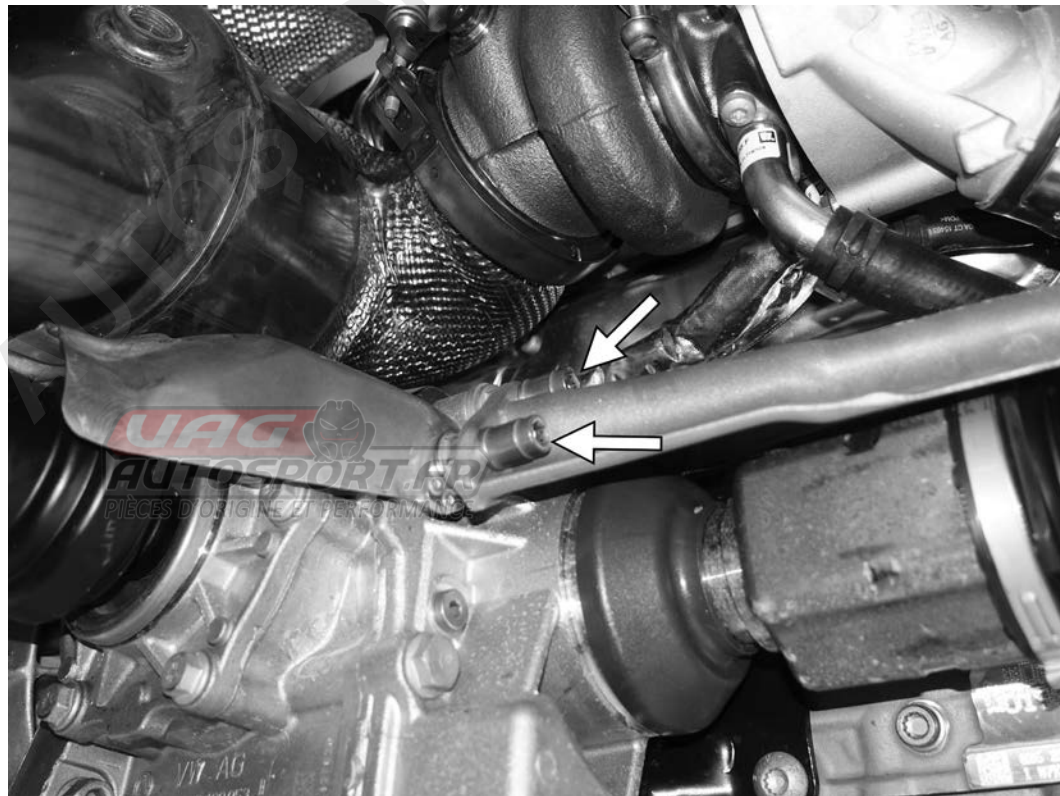

TL100116

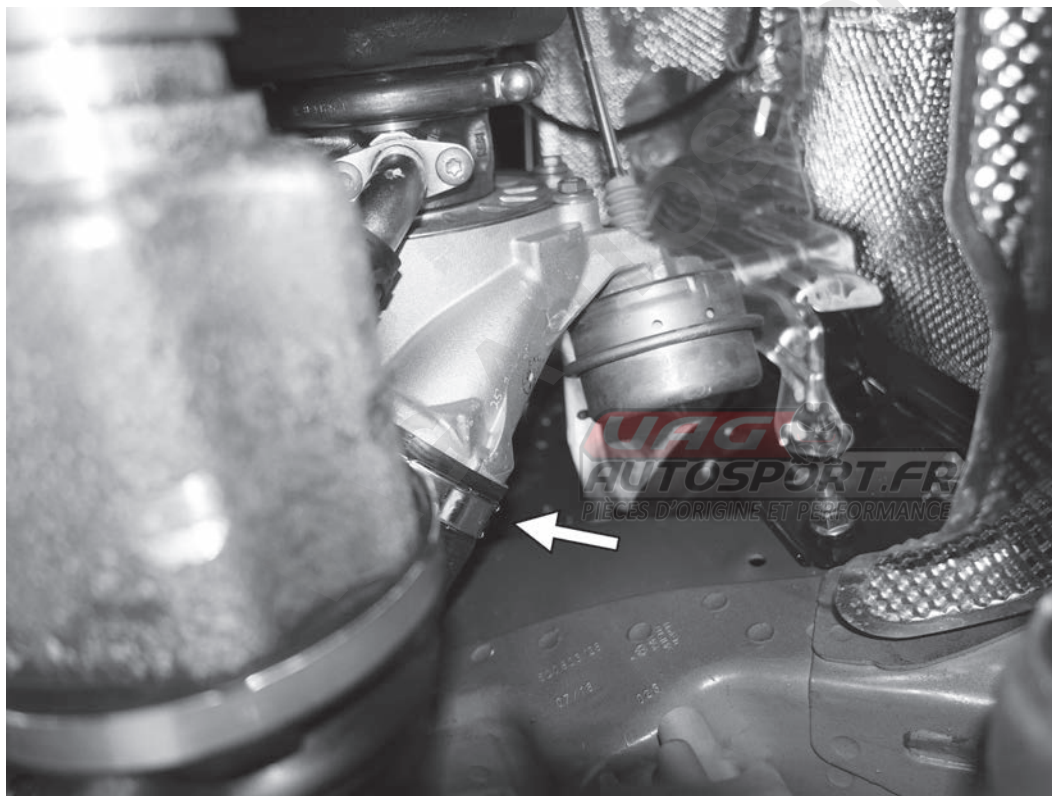

15) Loosen the clamp on the turbocharger outlet hose, nearest the turbocharger. A flathead screwdriver or 7mm socket will work for this. The clamp is affixed to the hose, so only loosen the clamp.

16) On the front side of the turbo outlet pipe, loosen the hose clamp for the intercooler hose at the pipe. Then, remove the T30 screw from the bracket holding the outlet pipe to the engine block at the engine block.

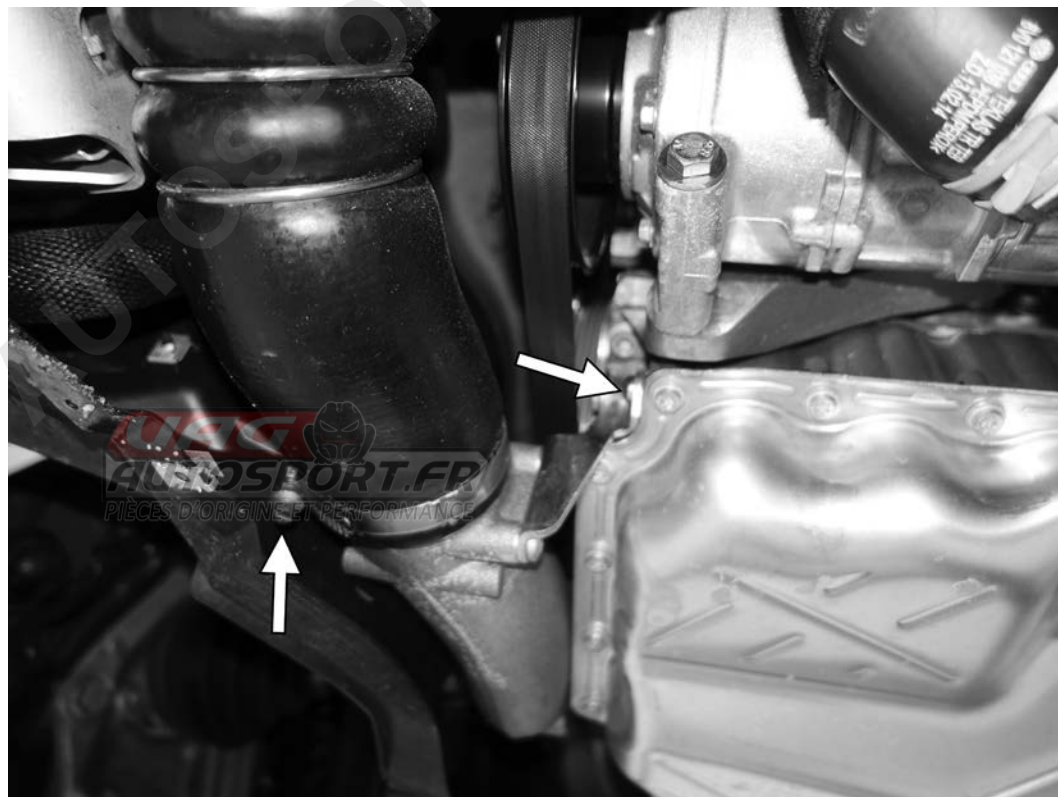

TL100116

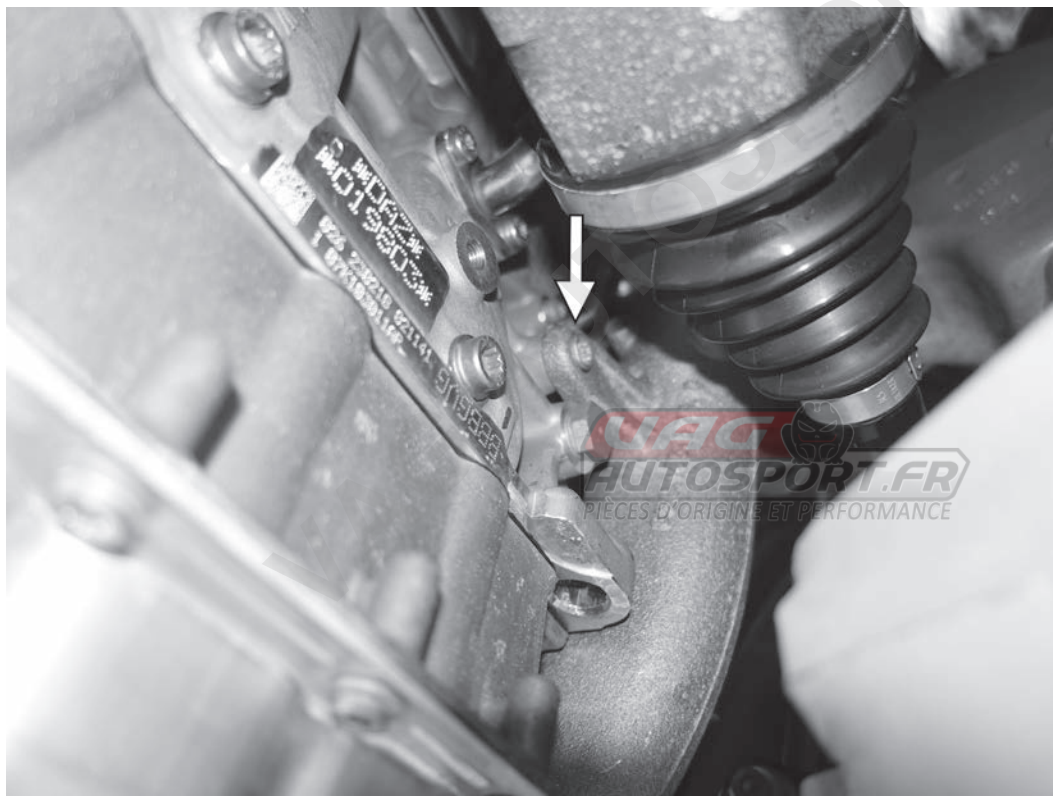

17) Remove the 10mm triple square screw holding the turbo outlet pipe to the back of the engine block.

18) Separate the intercooler hose from the turbo outlet pipe. The hose clamp is affixed to the intercooler pipe.

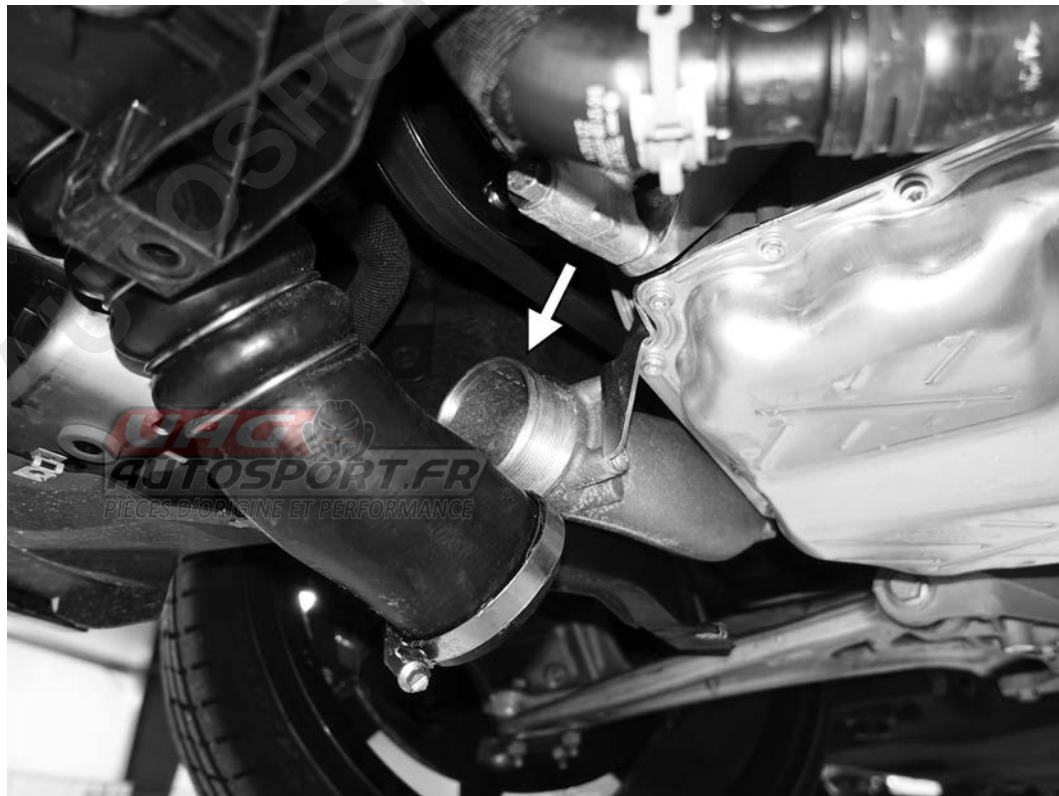

TL100116

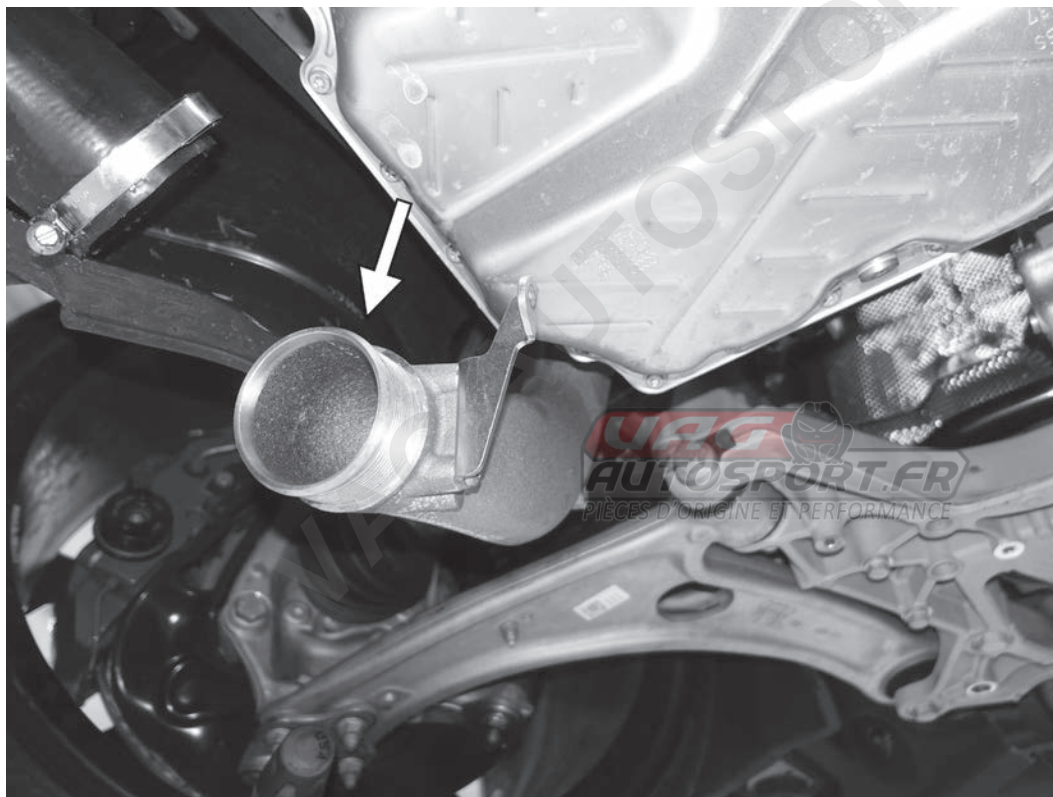

19) Remove the turbo outlet pipe by pulling the pipe down from the car. It may be necessary to use a large, angled pick to separate the rubber hose from the turbocharger outlet at the previously loosened clamp.

20) Remove the remaining lower T30 screw that holds the stock turbo inlet pipe to the turbocharger.

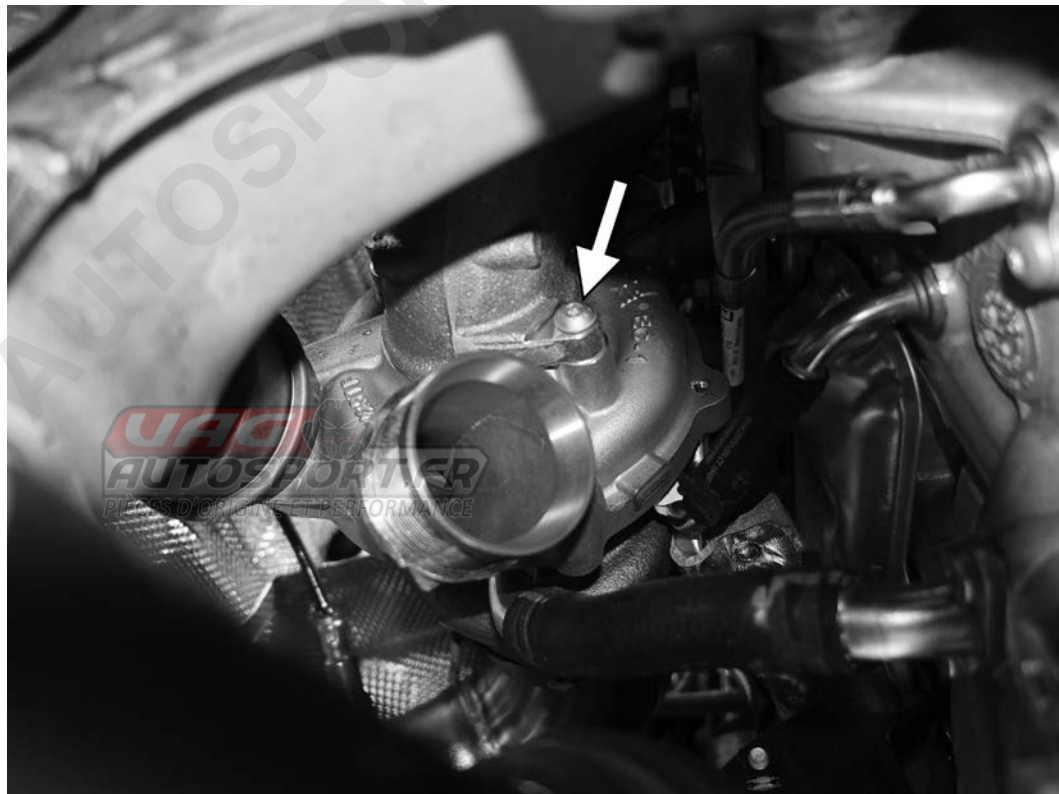

TL100116

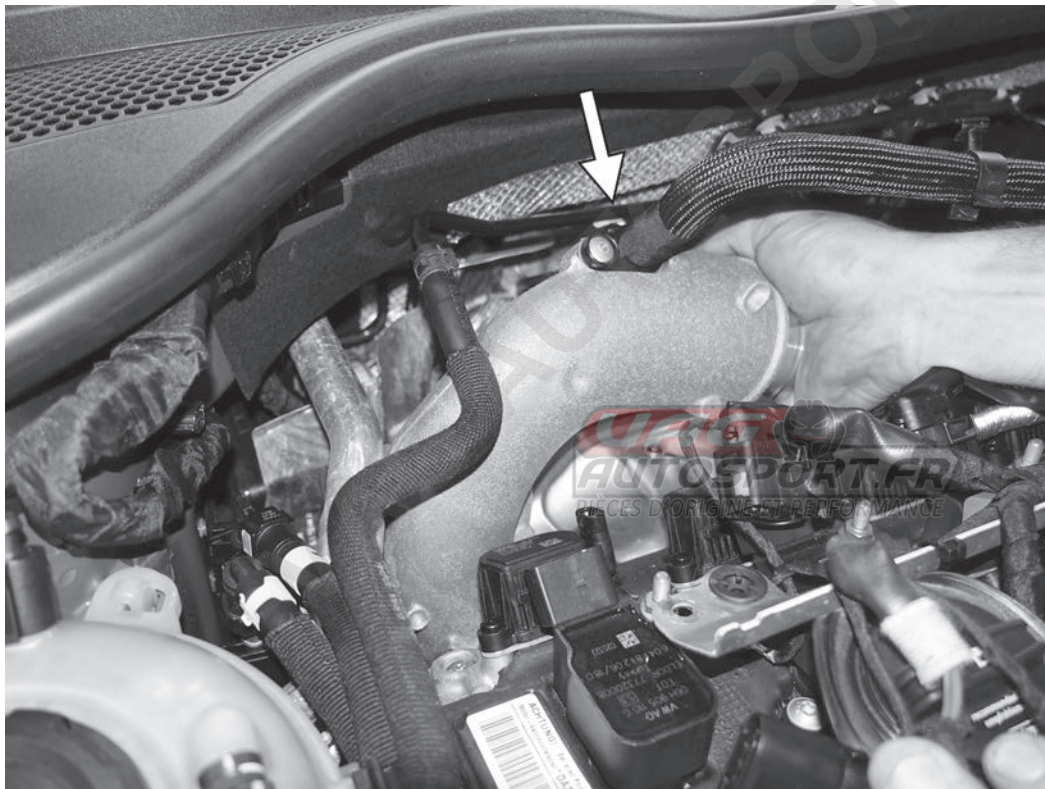

21) Lift and remove the stock turbo inlet pipe from the car, along with the attached PCV hose.

22) Using a dremel or hacksaw, cut a slot across the top of the screw holding the PCV hose to the stock turbo inlet pipe. Take care to avoid cutting too much of the plastic around the screw.



TL100116

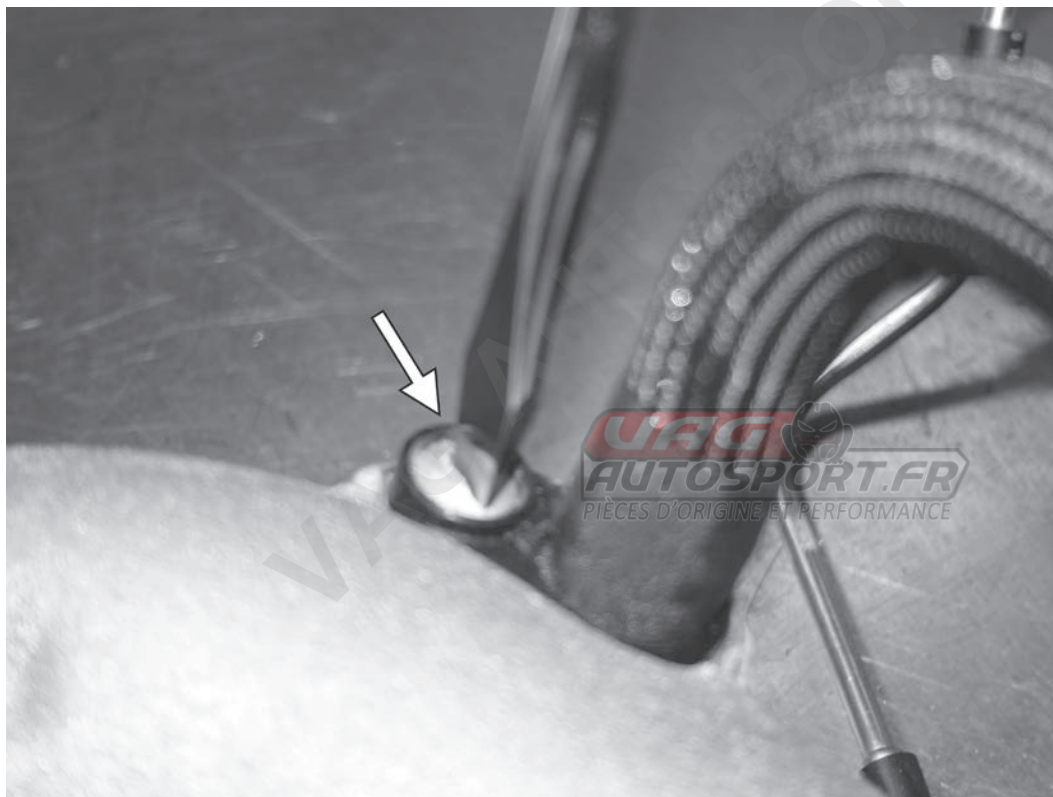

23) Using a large flathead screwdriver, push down on the previously cut slot and turn the screw to remove the PCV hose. It is easier to turn the screw if the screw is still warm from grinding the slot in it.

24) Remove the small metal gasket from the stock turbo inlet pipe, and transfer it to the adapter ring on the APR turbo inlet pipe.



TL100116



25) Remove the 4mm allen screw from the APR turbo inlet pipe and set aside for use later.

APR

26) Place the APR turbo inlet pipe into the car, setting the end on the inlet of the turbocharger.



TL100116

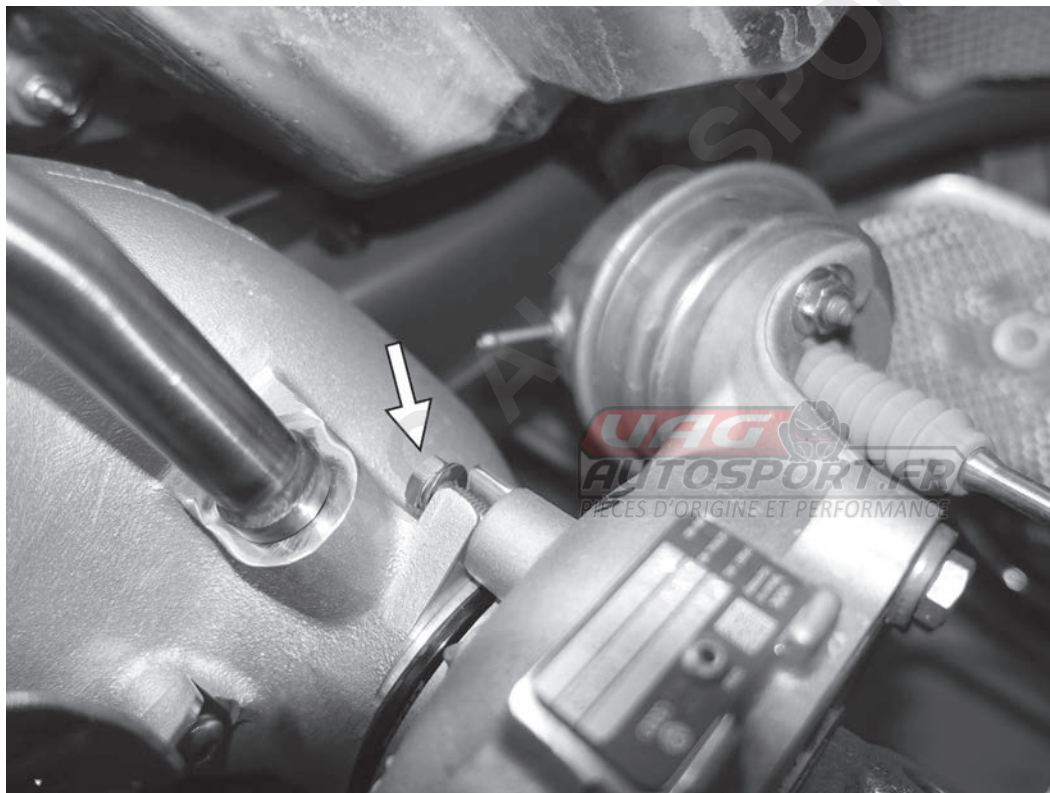

27) On the supplied 10mm screw, put a drop of medium strength, blue threadlocker, like Loctite 246. Install the wedge lock washer onto the screw, being careful not to separate the two halves of the lock washer. Very loosely install the supplied 10mm screw and wedge lock washer into the upper mounting hole on the turbo, holding the APR turbo inlet pipe to the turbocharger.

28) Make sure the APR turbo inlet pipe is properly seated in the turbocharger. Put a drop of medium strength, blue threadlocker, like Loctite 246, onto the 10mm screw. Install the wedge lock washer onto the screw, being careful not to separate the two halves of the lock washer. Install the other supplied 10mm screw and washer to the lower hole on the APR turbo inlet pipe. Torque both the lower and upper 10mm screws to 80 in-lb (9Nm).



TL100116

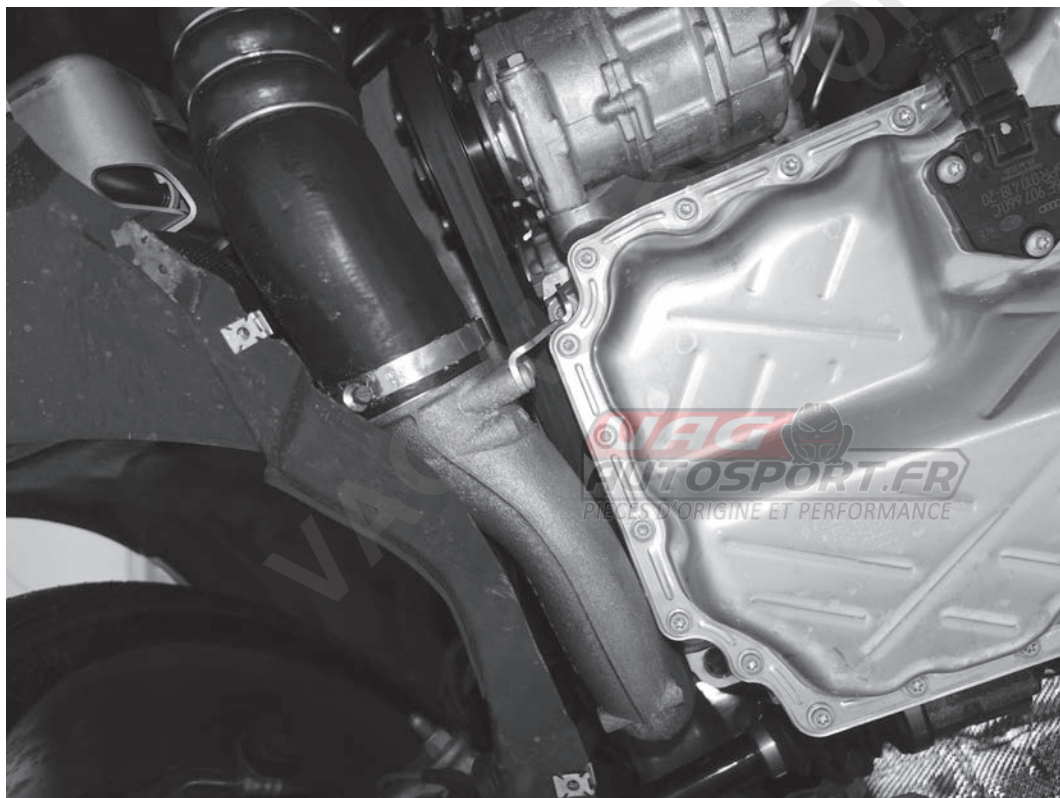

29) Reinstall the stock turbo outlet pipe, connecting the hose from the pipe to the turbocharger outlet and connecting the intercooler hose to the front side of the pipe. Loosely reinstall the T30 screw holding the front outlet pipe bracket to the engine block.

30) Reinstall the 10mm triple square holding the turbo outlet pipe to the back of the engine block. Torque this bolt to 177 in-lb (20Nm).

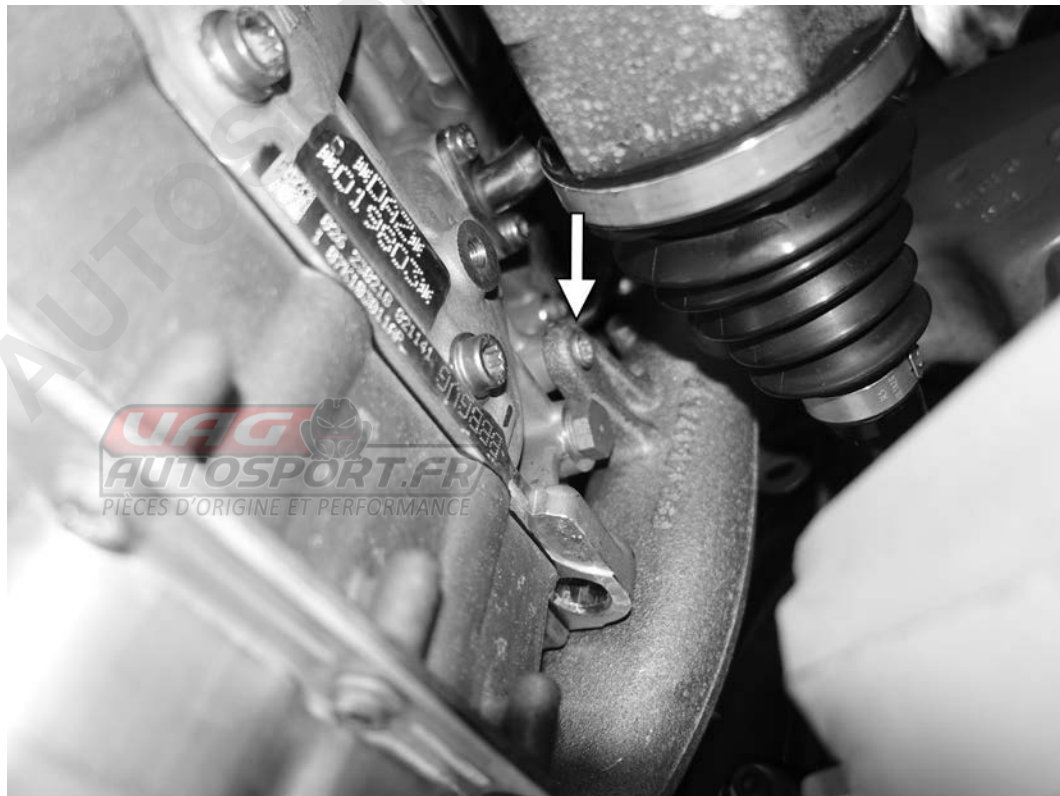

TL100116

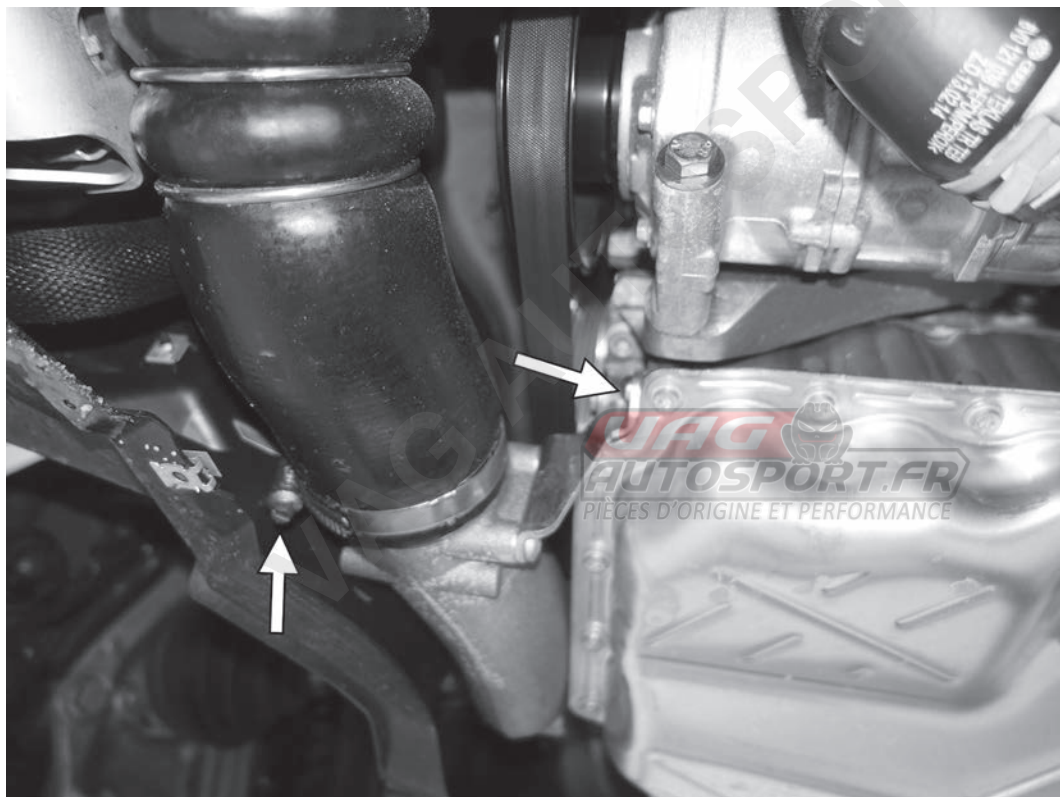

31) Torque the T30 screw on the turbo outlet pipe bracket to 70 in-lb (8Nm). Tighten the 7mm screw on the hose clamp connecting the outlet pipe to the intercooler hose by torquing it to 48 in-lb (5.5Nm). Do not overtorque the clamp or the screws.

32) Reinstall the right axle heat shield with the two 8mm allen nuts. Torque the allen nuts to 220 in-lb (25Nm).



TL100116

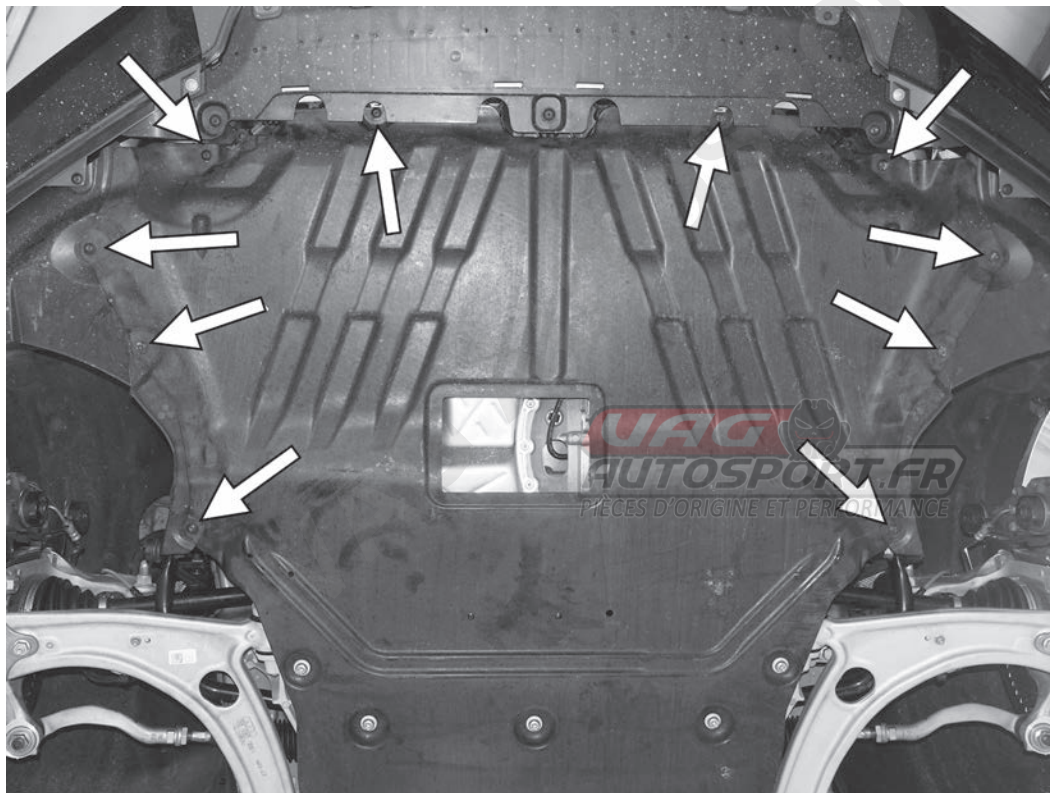

33) With an assistant, raise the belly pan back onto the car. Install the ten T25 screws on the front of the belly pan.

34) Install the five T45 screws on the back of the belly pan, and then install the two push-pin style connectors on the back of the belly pan.

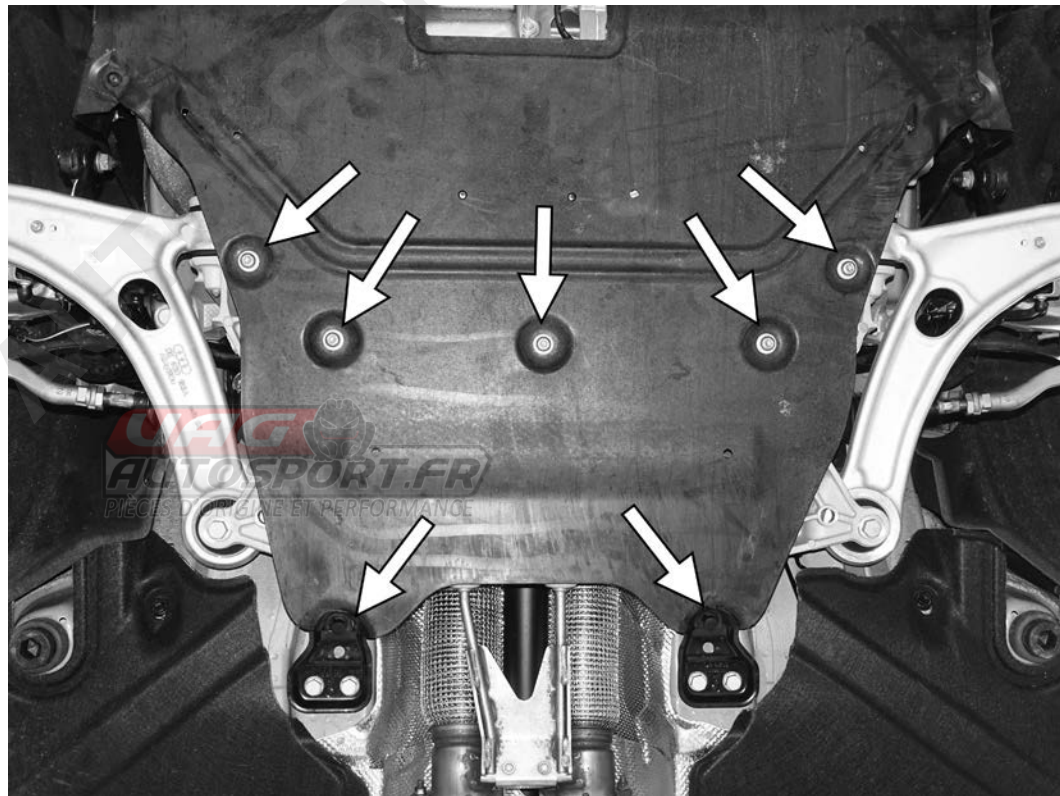

TL100116



35) Rotate the end of the stock PCV hose approximately 180° by holding the hose and rotating the plastic fitting. It is not necessary to remove the fitting from the hose.

36) Install the PCV hose to the APR turbo inlet pipe with the previously removed 4mm allen screw. Torque to 88 in-lbs (10Nm).



TL100116

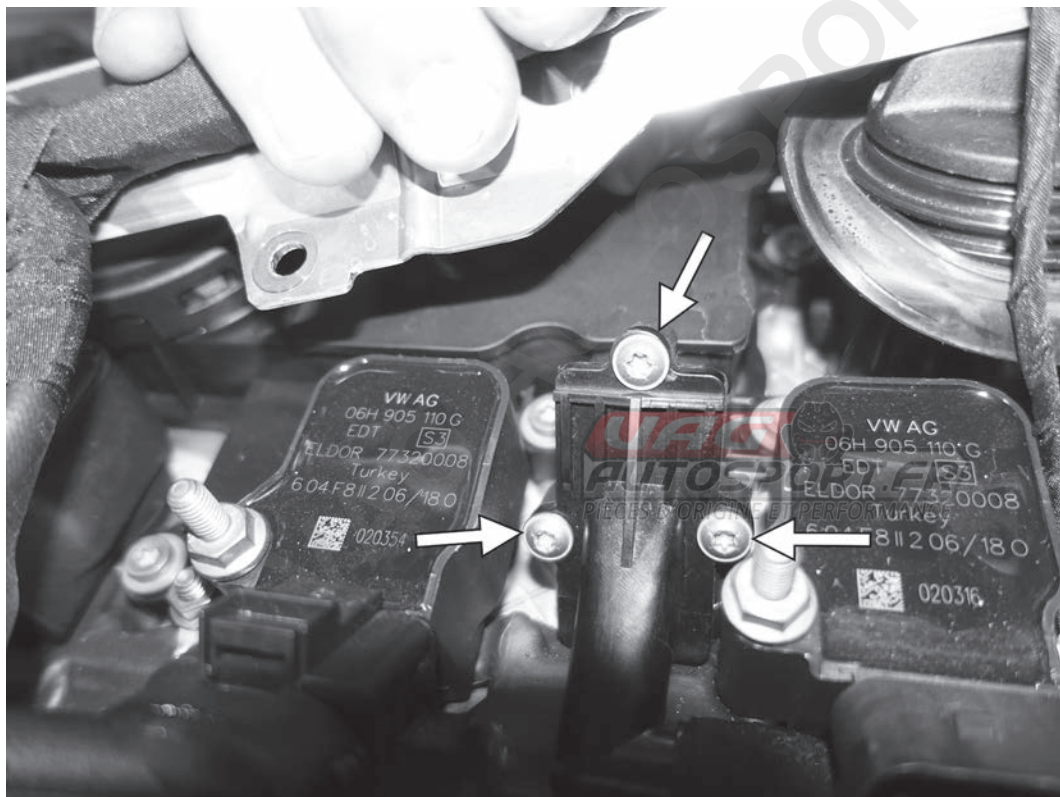

37) Reroute the PCV hose as it was originally from the factory, and reconnect it to the PCV valve between ignition coils #1 and #2 with the three original T20 screws. Torque the screws to 31 in-lbs (3.5Nm).

38) Set the metal bracket back on top of the ignition coilpacks. Reconnect the electrical connectors to the cylinder #1 and #2 exhaust valvelift solenoids. Reconnect the electrical connectors to the cylinder #1 and #2 ignition coils.

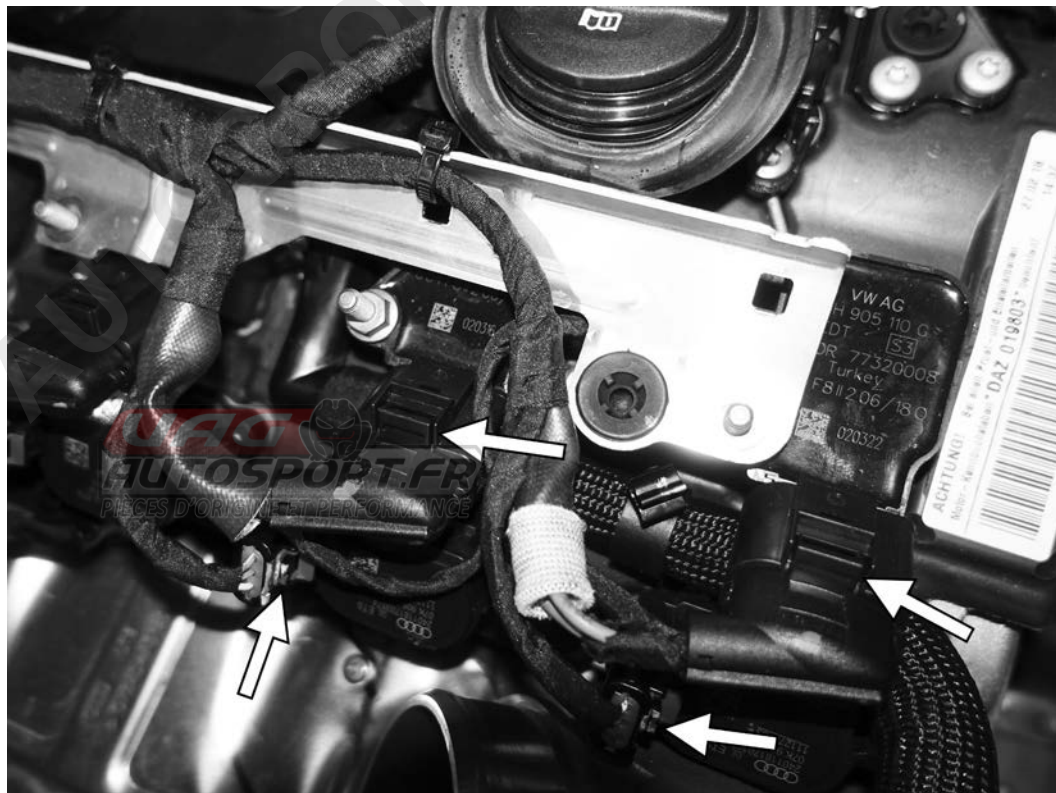

TL100116

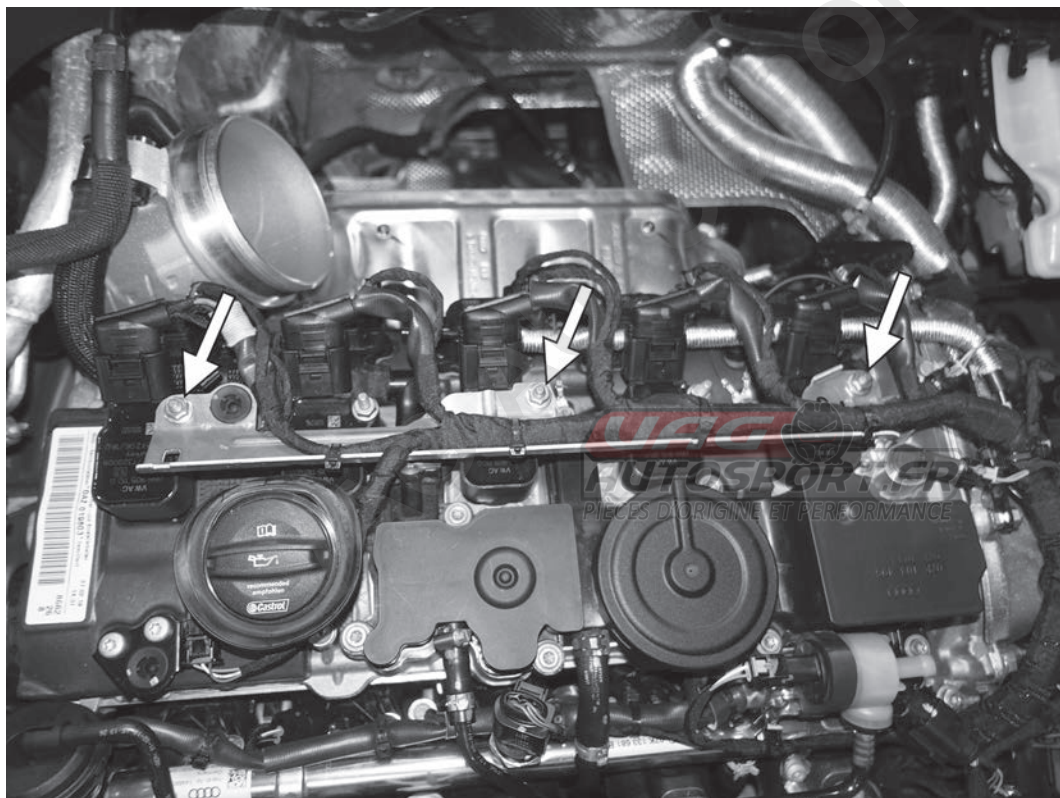

39) Install the three 10mm nuts that hold the metal bracket to the ignition coils, and torque to 62 in-lbs (7Nm).

40) Install the two small crimp clamps onto the supplied braided hose.

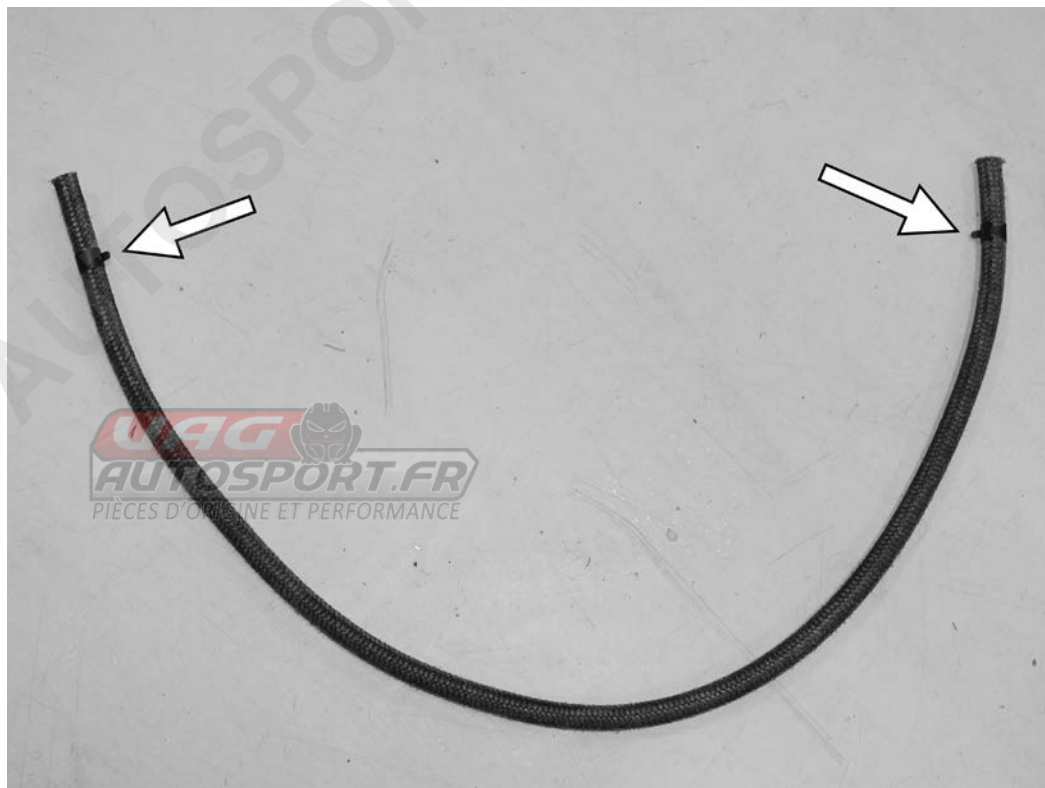

TL100116

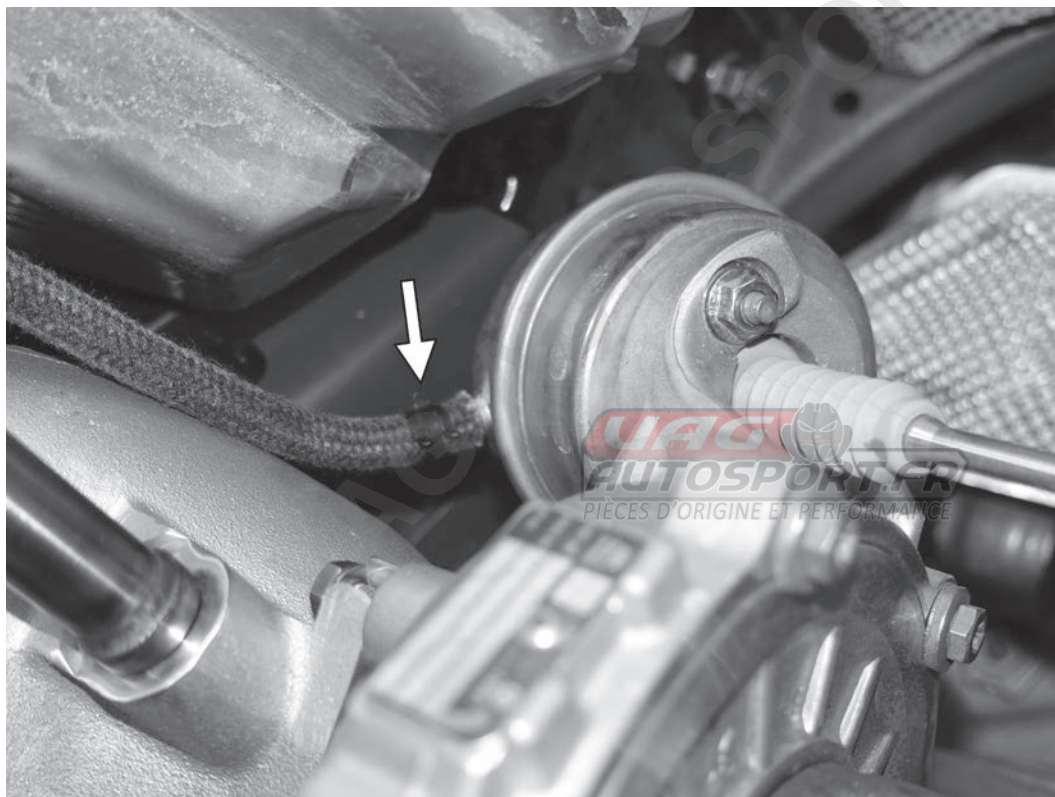

41) Connect one end of the braided hose to the port on the turbocharger wastegate. Route the rest of the line up, following the right side of the APR turbo inlet pipe.

42) Route the hose up and under the AC lines and PCV hose and to the left along the back side of the engine. Route the hose in the same location the OEM metal line ran.



TL100116

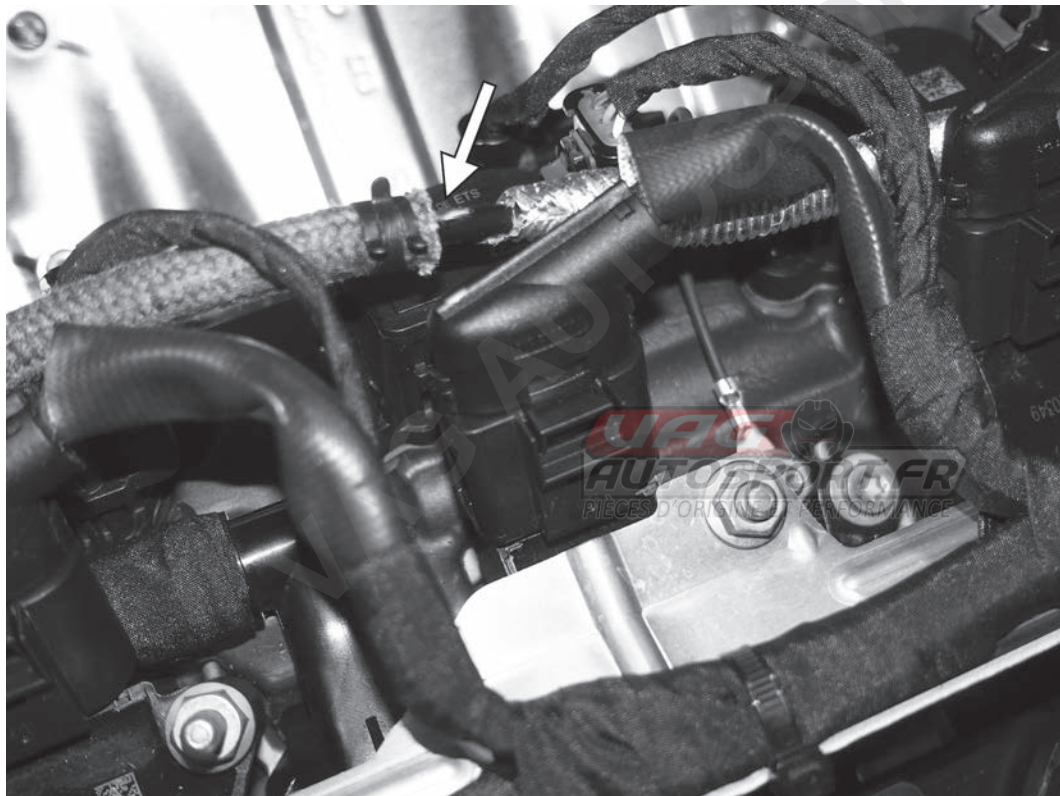

43) Connect the other end of the braided line to the plastic hose that goes to the boost control valve (N75). Secure the connection with the crimp clamp.

44) Loosely assemble the intake tube as shown with the straight silicone coupler, the accordion silicone coupler, and four hose clamps.



TL100116



45) Take the T30 screw that held the stock intake to the back of the cylinder head, and add the supplied large washer.

46) Install the APR intake on the car, connecting to the APR turbo inlet pipe and the factory airbox. Install the T30 screw with large washer to the tab on the bottom of the intake tube, securing the intake to the cylinder head. Torque the T30 to 80 in-lb (9Nm). Adjust the four hose clamps, and then tighten them to 5 in-lb (0.6Nm). Do not overtorque the clamps, as you can crush the carbon fiber intake. This torque spec is very low, but the intake will be secure.





47) Make the shown assembly using the supplied parts. Crimp the barbed connection to the hose using one of the 19.8mm ear clamps.

APR

48) Install the barbed side of the fitting to the APR accordion intake tube with the remaining 17mm ear clamps. Connect the other end of the hose to the crankcase vent valve (N546) and secure with the remaining 19.8mm ear clamp. Reinstall the engine cover.

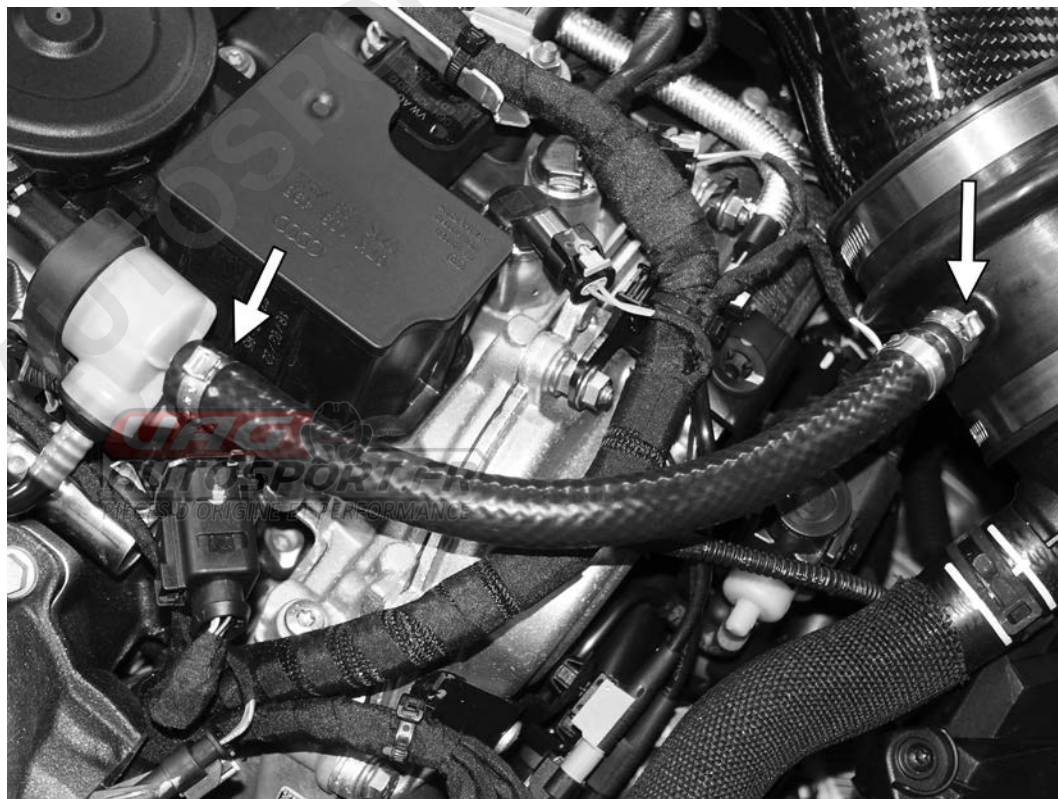

TL100116

VAG AUTOSPORT



VAG AUTOSPORT



#TL100116

VAG AUTOSPORT



GO APR.COM