



**VAG**  
**AUTOSPORT FR**  
PIÈCES D'ORIGINE ET PERFORMANCE

**APR**  
**MK7 GTI**  
**CATBACK EXHAUST SYSTEM**

VAG AUTOSPORT



---

Notes:

These instructions were written for a North American specification Mk7 GTI.

When disassembling the car, be sure to keep all fasteners so they can be reused. It is recommend that you get some kind of compartmented tray to organize the fasteners, such as a fishing tackle box or several large ice cube trays. Fasteners that are not reused for reinstallation are noted in the instructions. All directions used in this manual (right, left, front, etc.) are based on if you were sitting in the drivers seat of the car.

These instructions assume that you have basic mechanical skills and several varieties of basic hand tools in order to install the kit. If you have any questions about the install, feel free to contact your APR representative.



1) Securely lift vehicle. If a vehicle lift is not used, secure the vehicle with jack stands. It is not necessary to remove the wheels, but will make installation easier.

**APR**

2) Remove the four 13mm bolts holding the front crossbrace under the exhaust in the center of the car, and remove the brace.

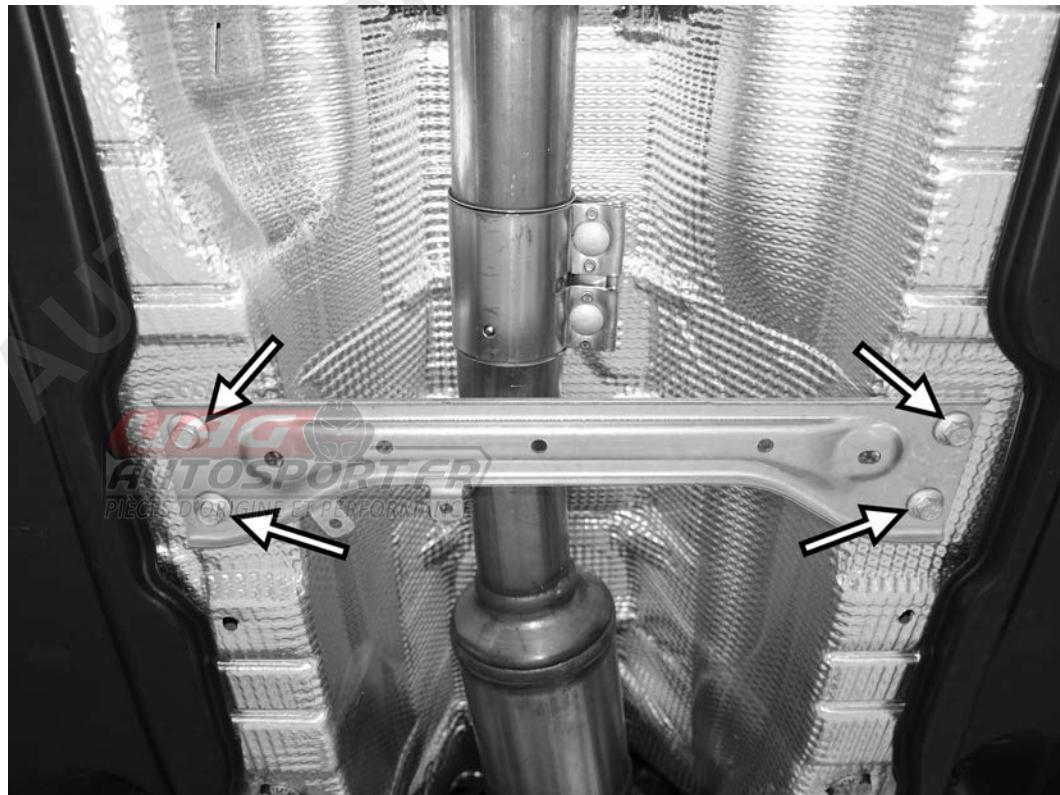

TL100107

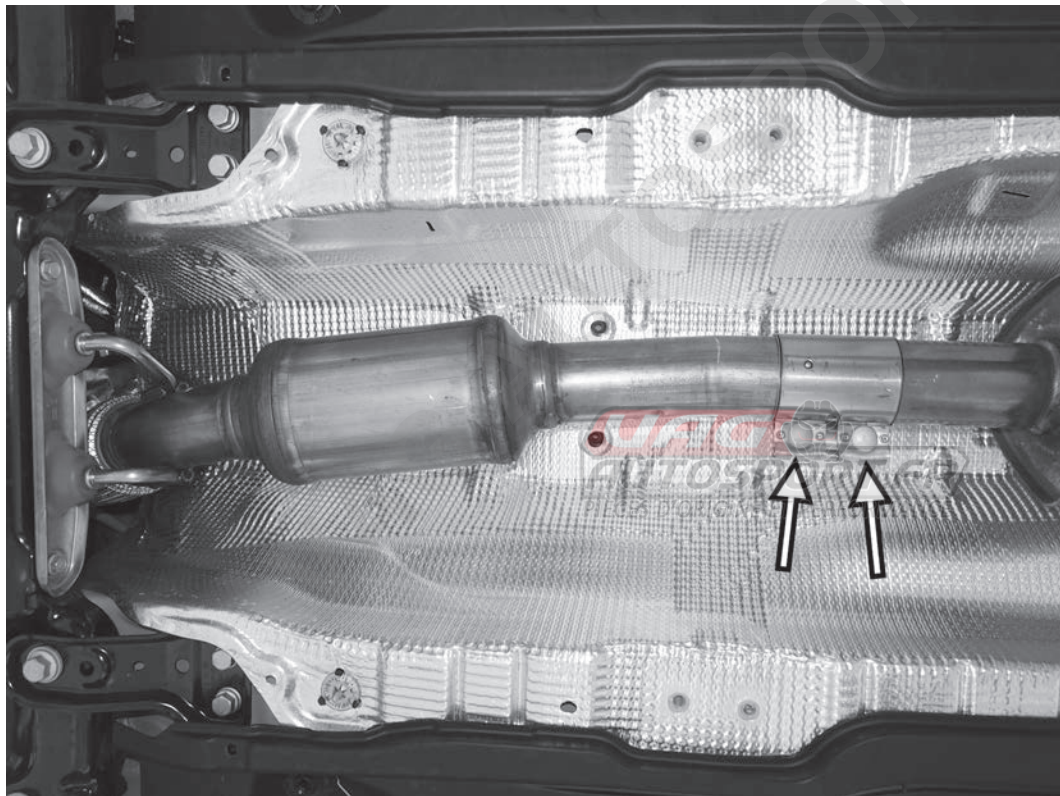

3) If the car has a stock DP, loosen the two 13mm nuts on the stock sleeve clamp at the back of the DP.

4) If the car has an APR Race DP, loosen the two 13mm nuts from the rear APR sleeve clamp before the reducer.

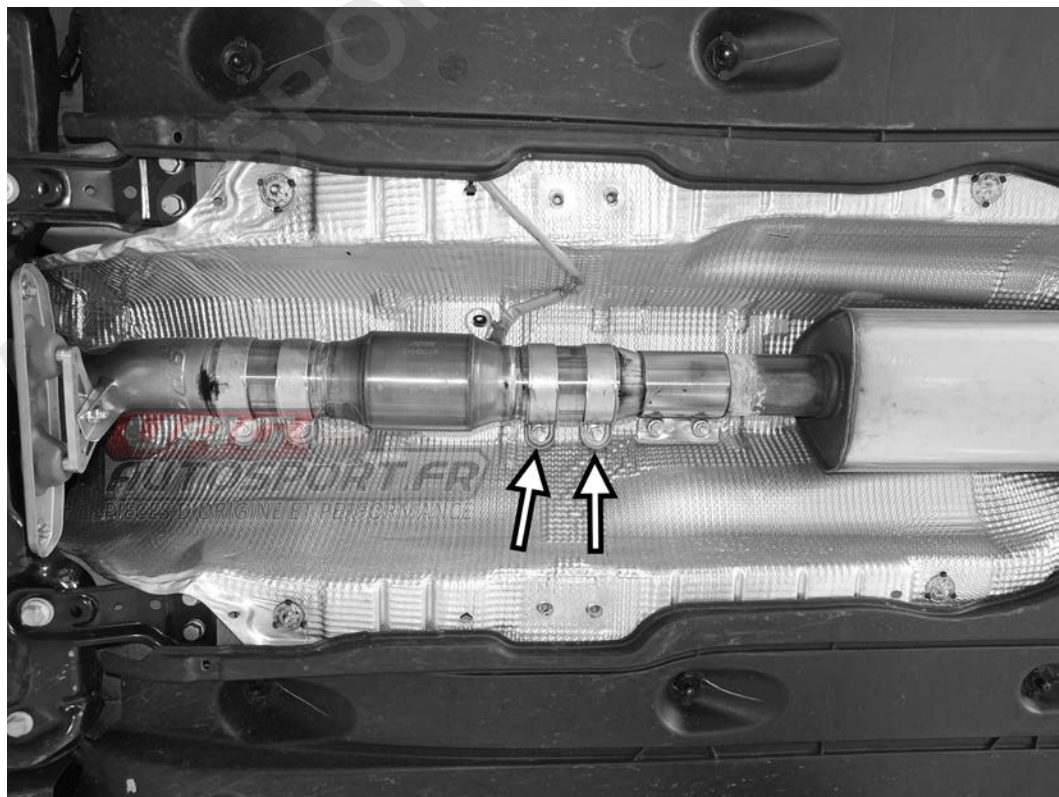

TL100107

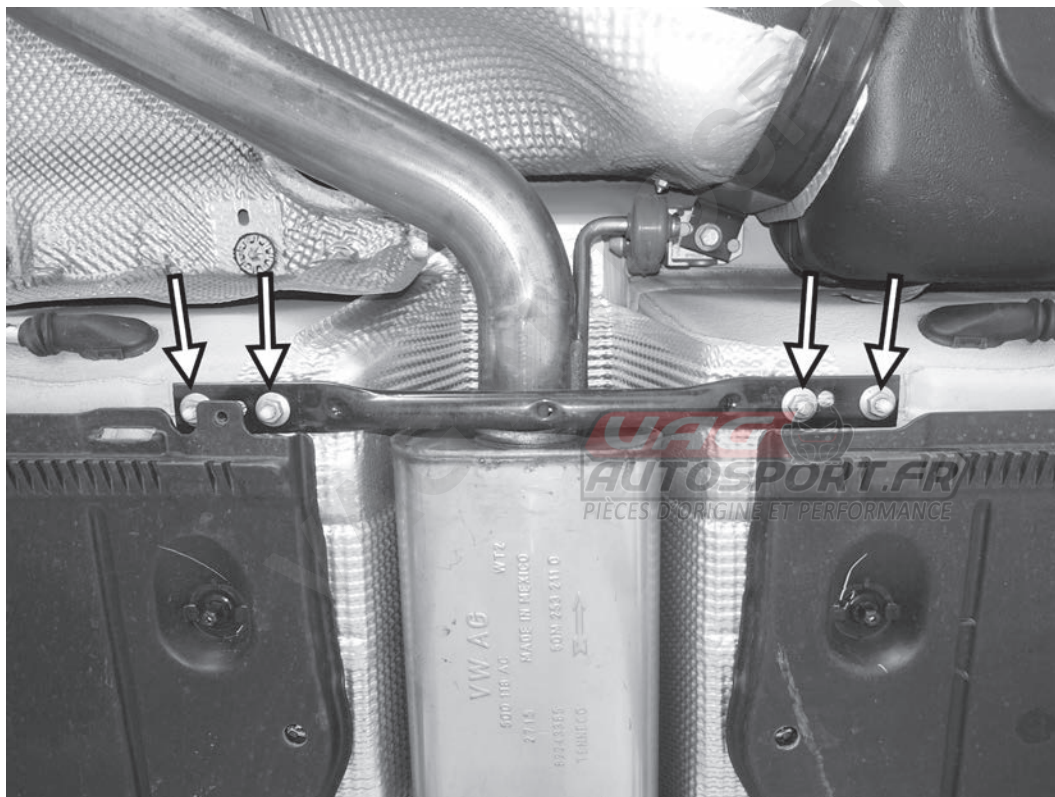

5) Remove the four 13mm nuts holding the brace at the back of the center tunnel, and remove the brace from the car.

**APR**

6) After putting some spray lubricant on the rubber hanger, remove the exhaust from the hanger, leaving the hanger attached to the car. The hanger can be separated with a pry bar or a tool made to remove rubber hangers.

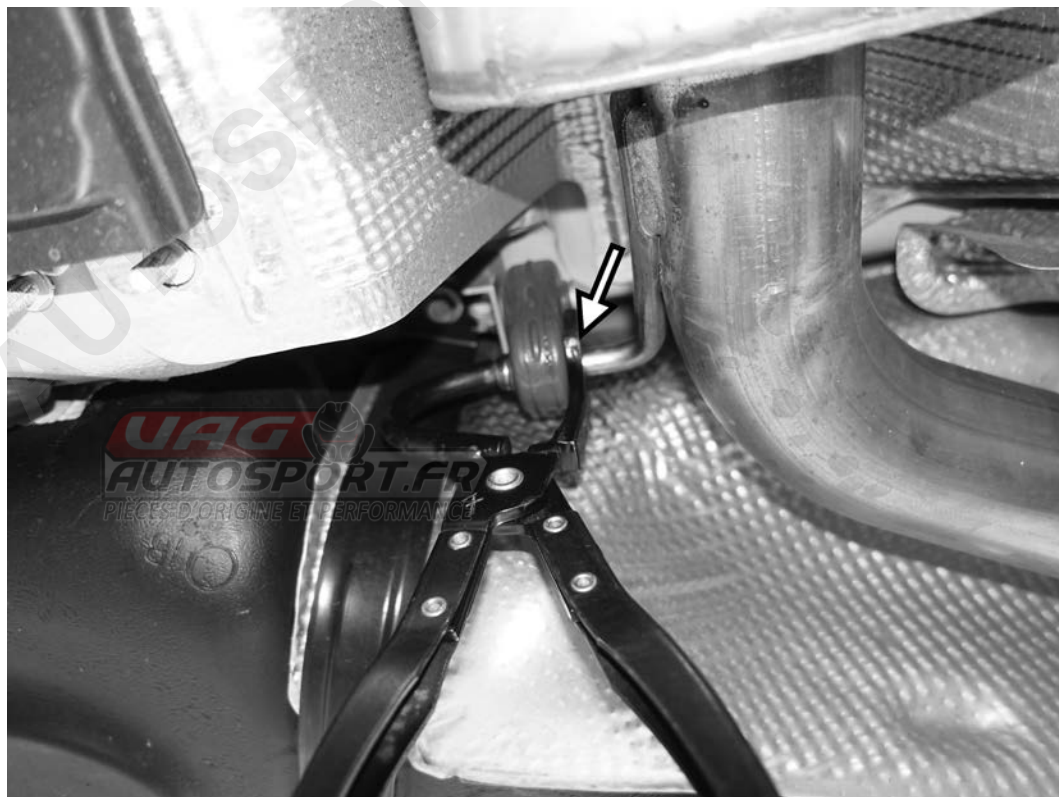

TL100107

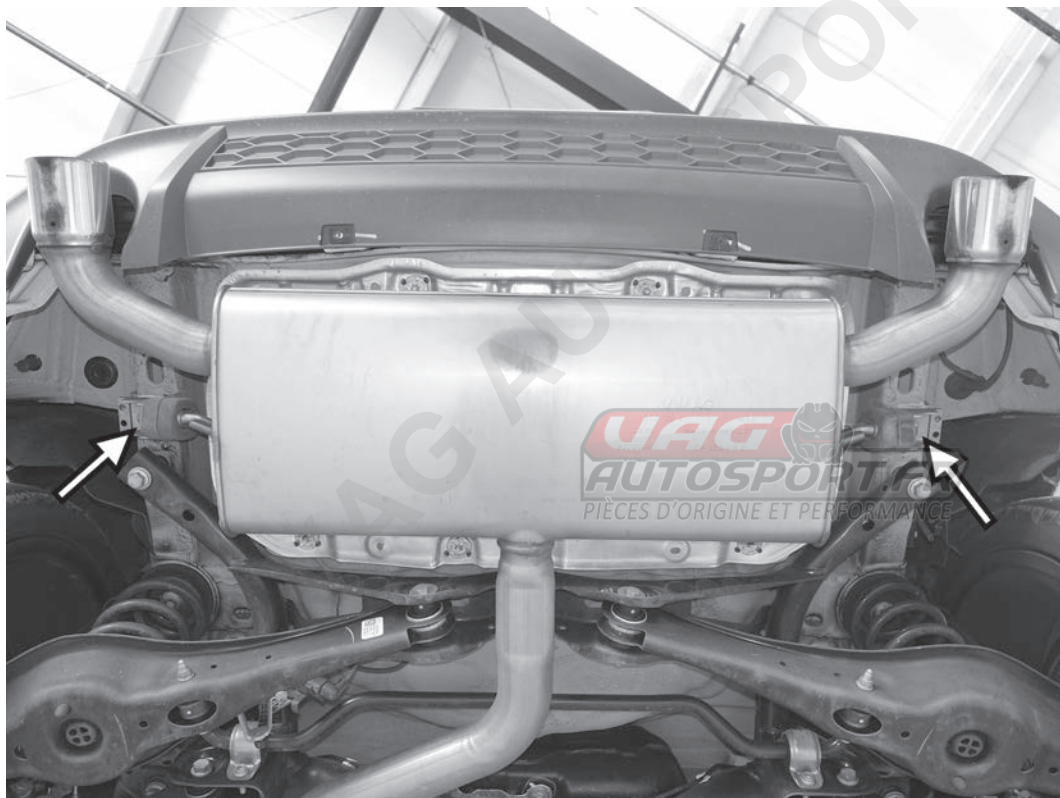

7) With an assistant holding the exhaust so it does not fall, remove the two 13mm bolts holding the rear muffler hanger brackets to the car.

8) Lower the exhaust system slightly, and then pull towards the back of the car to separate it from the DP. Set the exhaust on the ground, away from the car.



**TL100107**

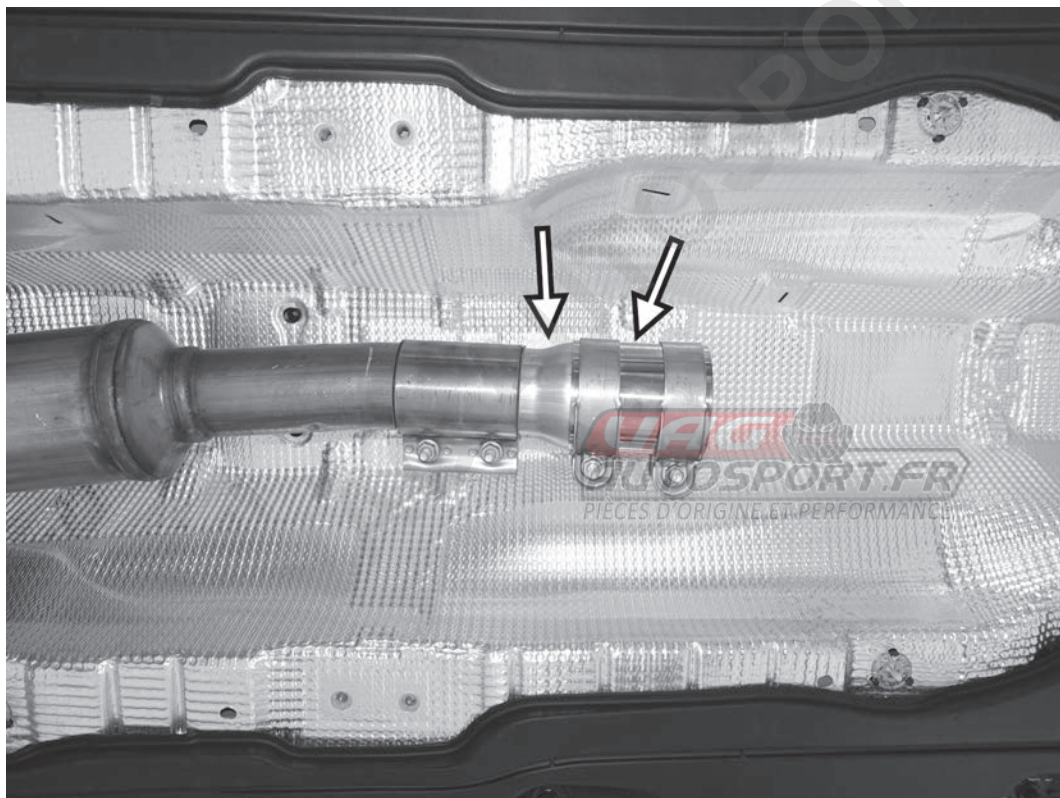

9) If installing with a stock DP, loosely place the small end of the reducing coupler into the stock sleeve clamp on the end of the stock DP. Loosely install one of the APR sleeve clamps on the big end of the reducing coupler.

**APR**

10) If installing with an APR Race DP, install the supplied 10" section of straight pipe with two of the sleeve clamps. Very loosely tighten the four 13mm bolts on the sleeve clamps so that the sleeves and straight pipe can still be manipulated.



TL100107

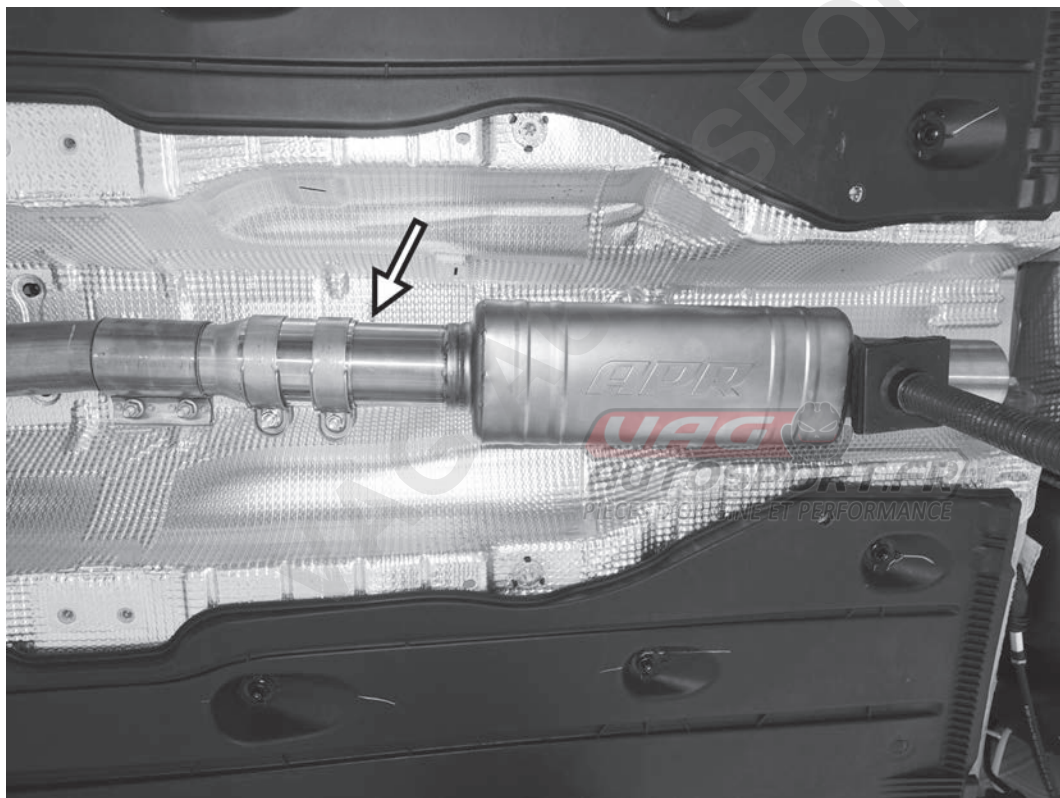

11) Loosely place the APR resonator or straight pipe into the back of the previously installed APR sleeve clamp. If installing the resonator, it should be oriented so the APR logo is facing the same direction as the APR logo on the muffler that is about to be installed.

**APR**

12) Locate the metal exhaust hanger on the rear subframe that was unused on the factory exhaust. Install the supplied rubber hanger on this factory mounting point.

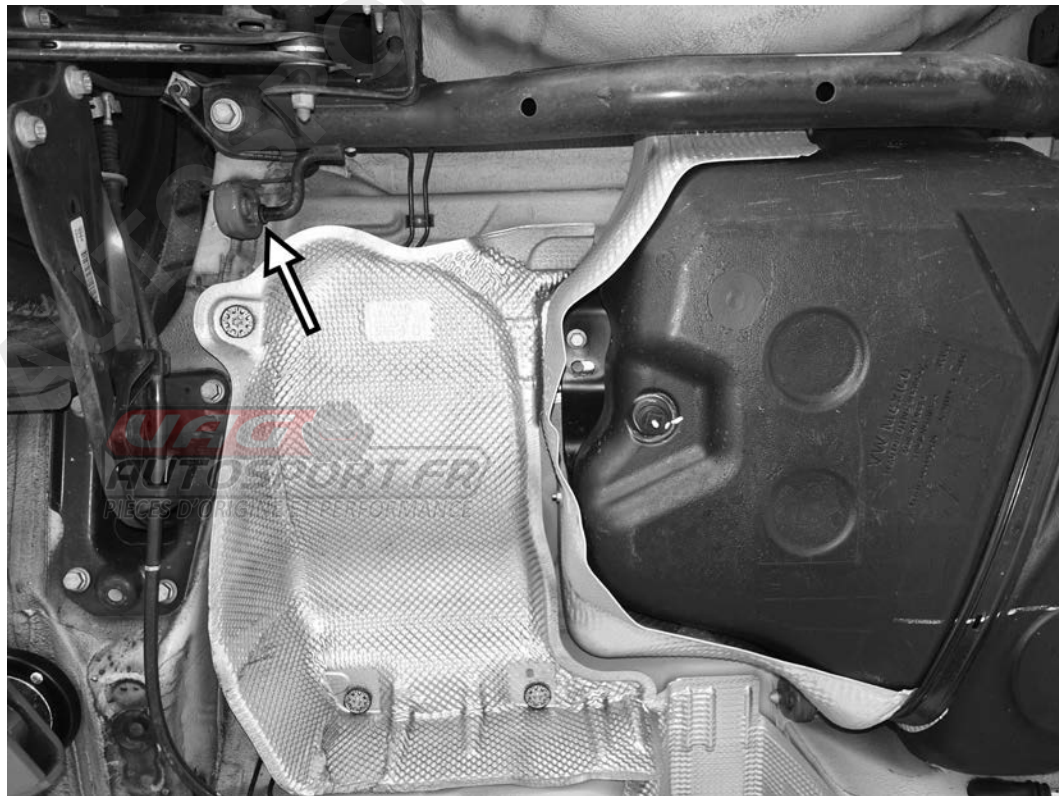

TL100107

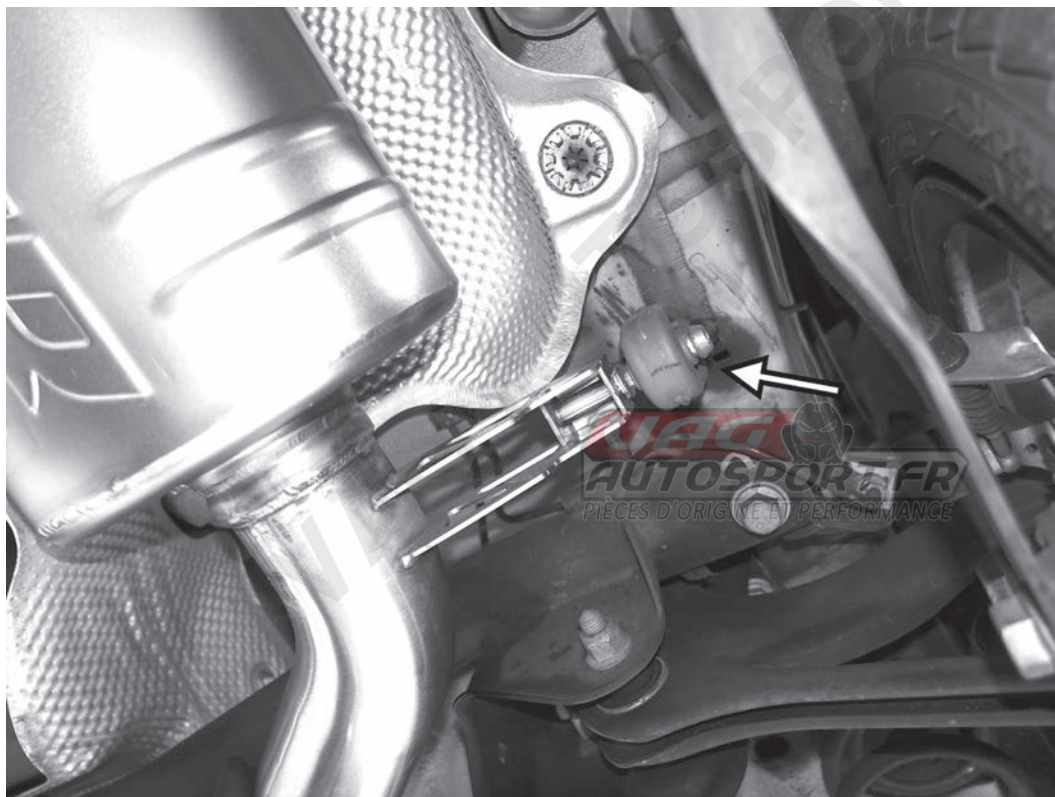

13) With an assistant, lift the APR muffler section to the car, and attached the rear hanger of the muffler section to the previously installed rubber hanger near the rear axle.

**APR**

14) Swing the front side of the APR muffler section up and push the post of the muffler into the hanger previously left on the car.



TL100107

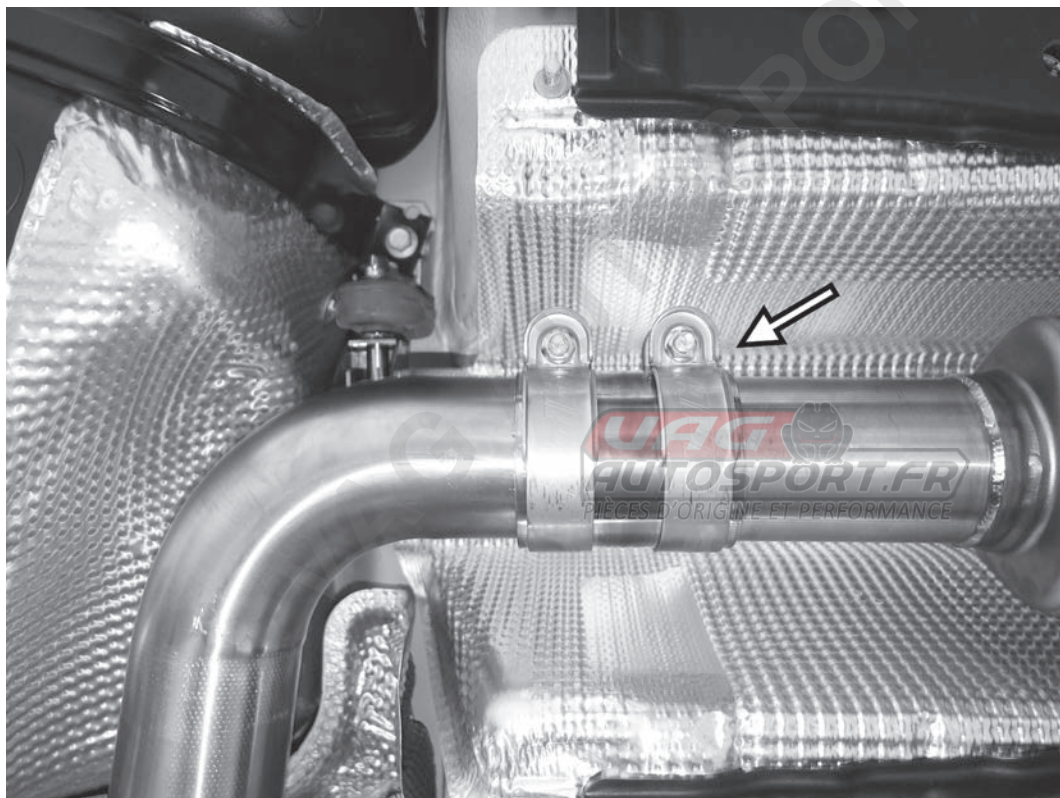

15) After confirming the orientation of the resonator is correct (the APR logo is in the same direction as on the muffler), slide a sleeve clamp on between the two sections. Loosely tighten the sleeve clamp so it can still be manipulated.

16) Install a sleeve clamp on the back of the APR muffler section.



**TL100107**



17) Put some spray lubricant on the rubber hangers on both sides of the stock rear muffler. Remove the two hangers with attached brackets from the exhaust. The hangers can be separated from the exhaust with a pry bar or a tool made to remove rubber hangers.

18) Install the two hangers with attached brackets on the APR rear section as shown, in the same orientation as on the stock muffler section.



**TL100107**

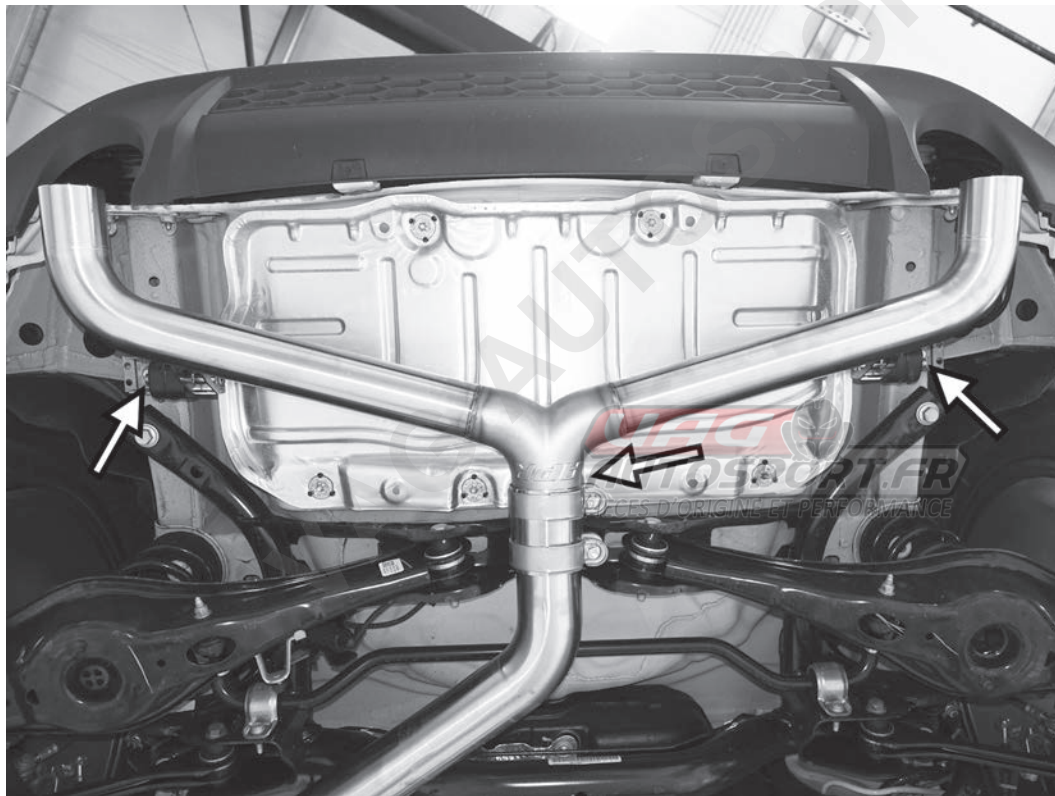

19) Slide the front portion of the APR rear section into the sleeve clamp on the back of the APR muffler section. Loosely install the two original 13mm bolts on either side of the back of the car, reattaching the rubber hanger brackets back to the car.

**APR**

20) Install the two APR tips with the two pinch clamps. Orient the clamps so they are sitting behind the rear bumper and cannot be seen from the back. Loosely tighten the clamps.

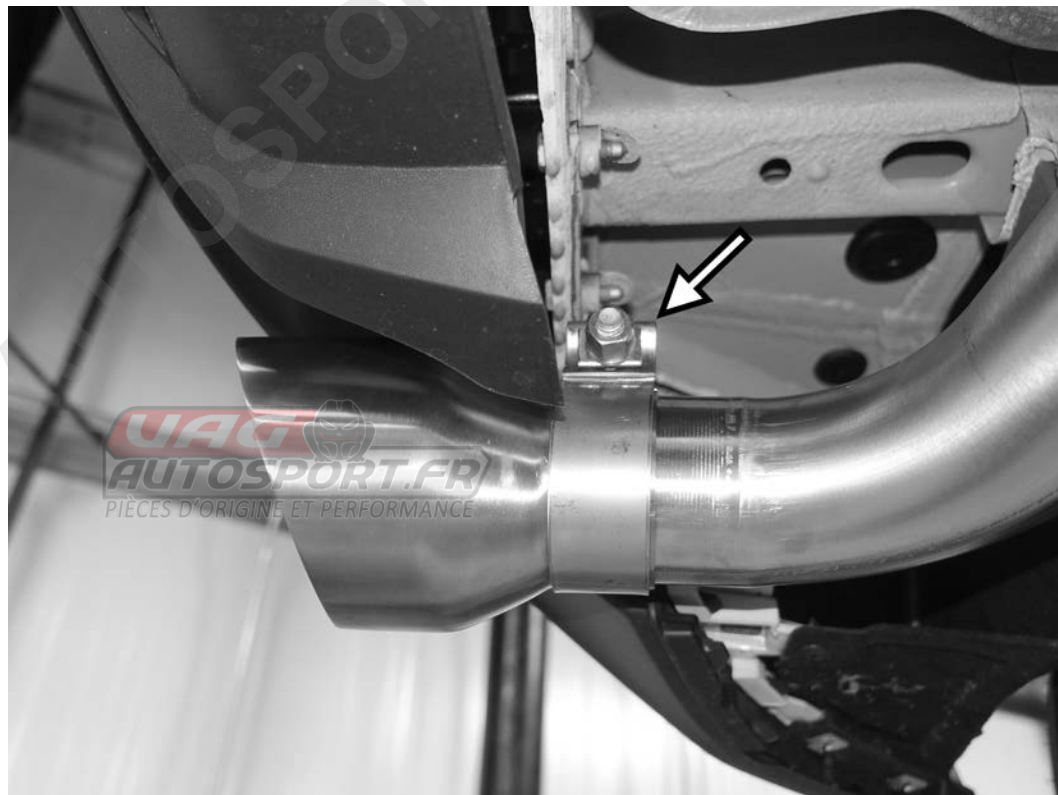

TL100107

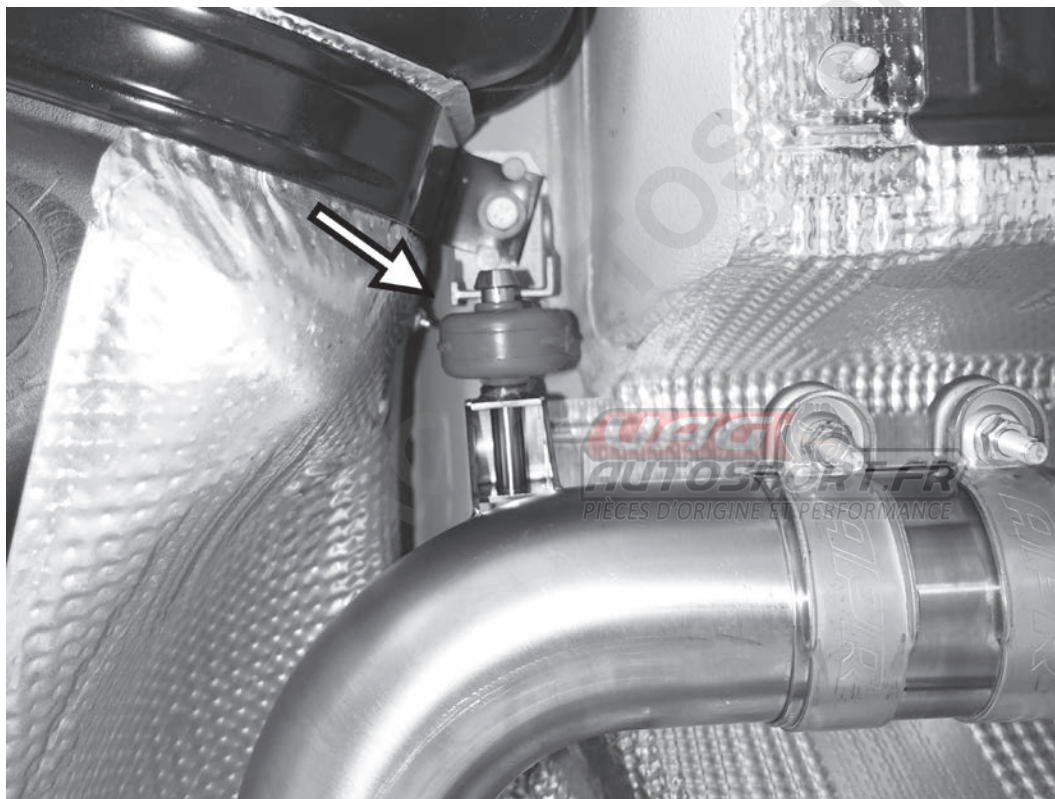

21) Working from the front of the car to the back, adjust the APR exhaust so all rubber hangers are facing straight down. The posts of the APR exhaust should hang directly below the factory posts the rubber hangers sit on. Once aligned, torque the sleeve clamps in the center tunnel of the car beginning with the most forward one to 25Nm (18 lb-ft).

**APR**

22) Ensure there is a sufficient gap between the rear subframe of the car and the rear clamp before tightening the sleeve clamps on the center muffler to 25Nm (18 lb-ft). Finally, torque the two 13mm bolts on the rear hanger brackets to 20Nm (15 lb-ft).



TL100107



23) Adjust the exhaust tips to your desired position before tightening the pinch clamps to 55Nm (40 lb-ft). Verify tip is securely in place.

**APR**

24) Reinstall the factory center brace with the four 13mm bolts, and torque the bolts to 20Nm (15 lb-ft).

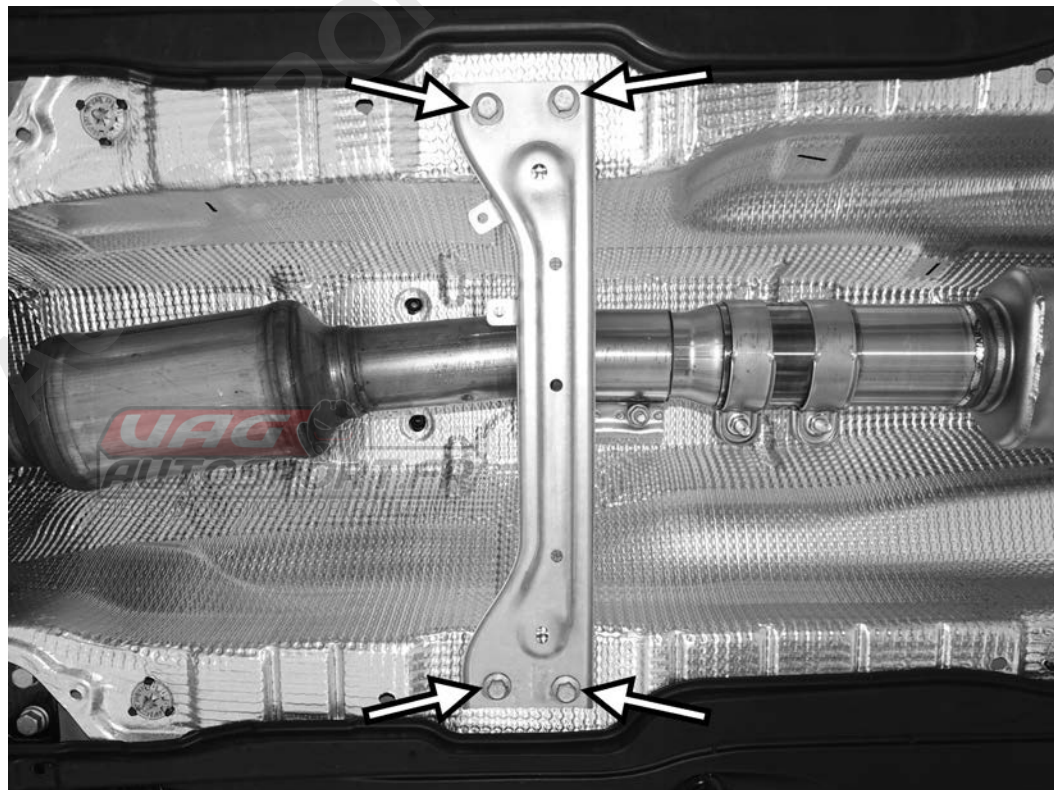

TL100107

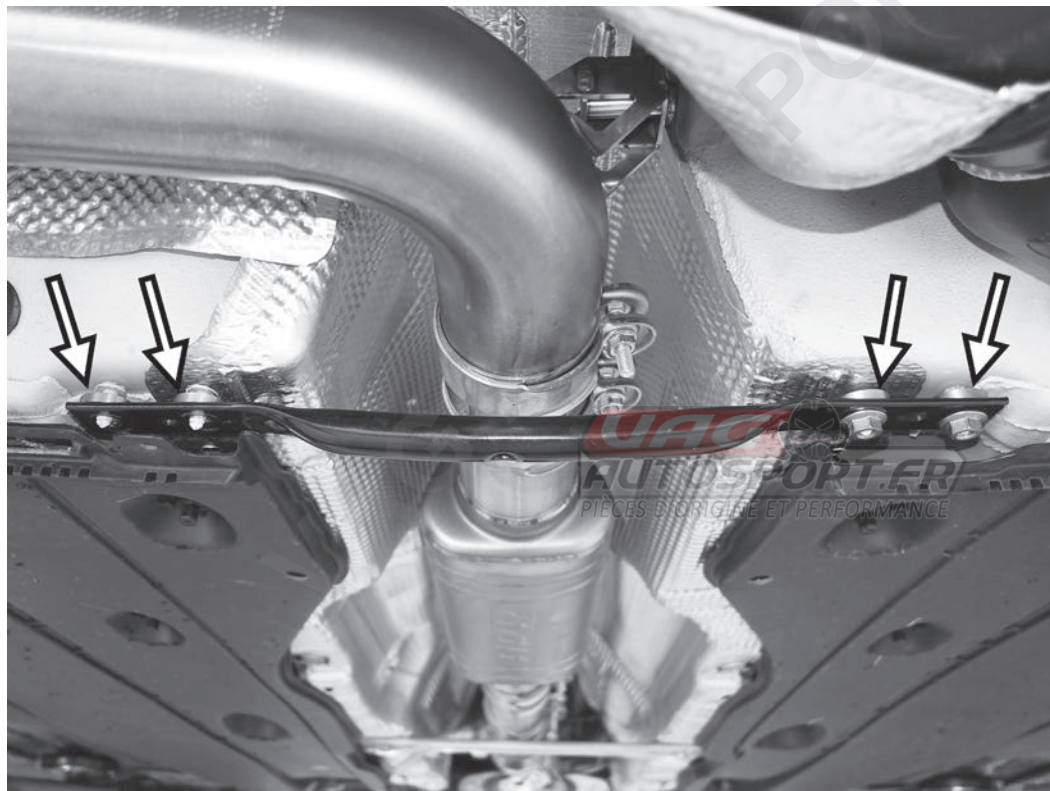

25) Reinstall the rear brace with the four supplied spacers between the brace and the chassis of the car. Use the original 13mm nuts to hold the brace with the spacers in place.

26) Torque the four 13mm nuts on the brace to 20Nm (15 ft-lb).

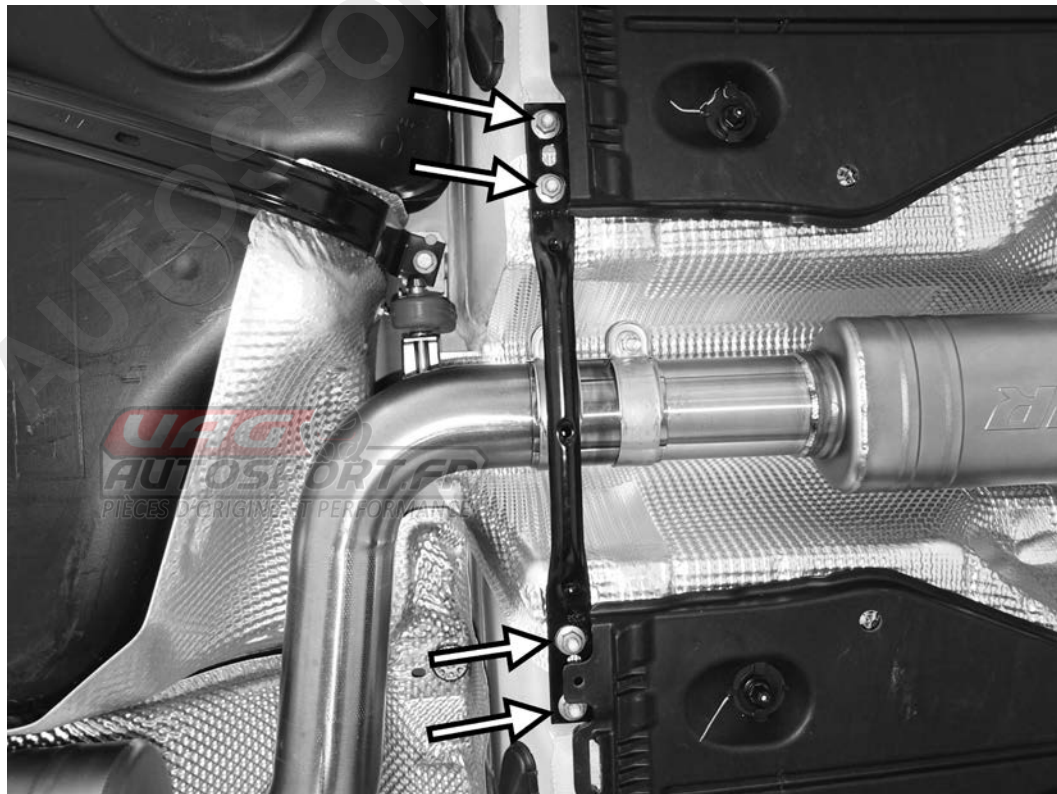

TL100107

VAG AUTOSPORT



VAG AUTOSPORT



VAG AUTOSPORT

