

#### B8 Allroad Catch Can Kit



This kit is designed to prevent oil from depositing in the intake manifold and intake valves, resulting in drastically reduced carbon buildup and extended life of the intake manifold flapper assembly.

#### Installation Spiciness Rating: MILD



Installation of your 034Motorsport Catch Can Kit is a straightforward process that will take approximately two hours to complete.

#### Supplied Parts:

- 034 Catch Can Assembly with Mounting Bracket
- 034 Valve Cover Breather Adapter with locating pin
- 034 Intake Plug with Mounting Bracket
- (2x) -10 AN Breather Hoses
- (2x) -10 AN Hose Separators with Hardware
- (8x) M6x25 Bolt
- (1x) M6x20 Bolt
- Zip-Tie

#### Tools Needed:

- T30 Torx Driver
- T27 Torx Driver
- 5mm Allen Bit
- 4mm Allen Bit
- Small flathead screwdriver
- -10AN Wrench or 1" Hex Wrench

#### About This Guide

This Install Guide documents the installation process on a B8 Audi Allroad. There may be minor differences depending on specific vehicle, market, options, etc.

#### Getting Started

Confirm you have received all the parts included with your purchase by reading the complete guide, if there are missing components, please contact:  
[customerservice@034motorsport.com](mailto:customerservice@034motorsport.com)

#### Install Steps

##### **Step 1**

Open your hood and frown at that plain engine bay.



##### **Step 2**

Remove engine cover by gently pulling upward.



##### **Step 3**

Use a flathead to disconnect the cam position sensor plugs from the main harness.

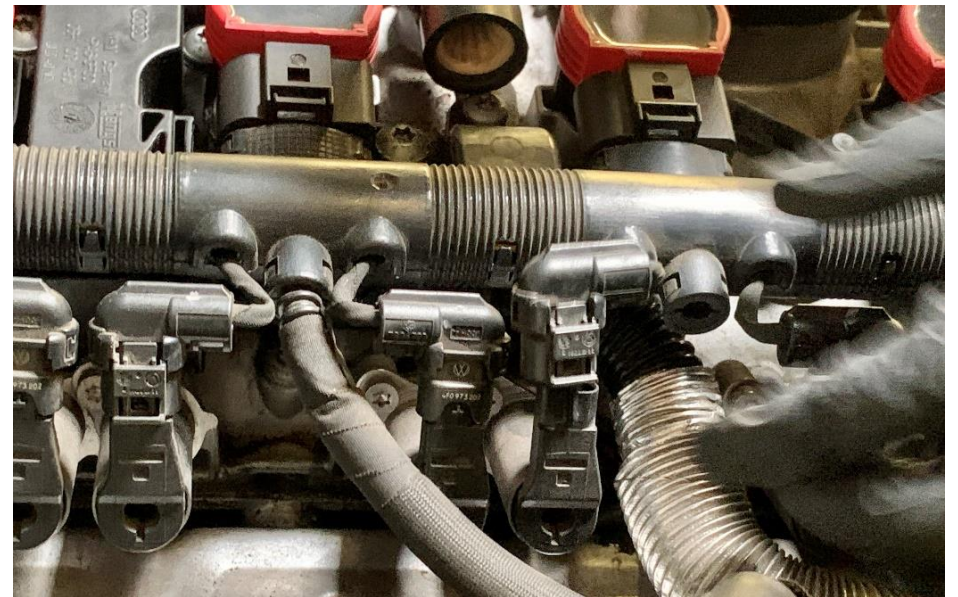

**Step 4**

Use a flathead to disconnect coils from the harness.

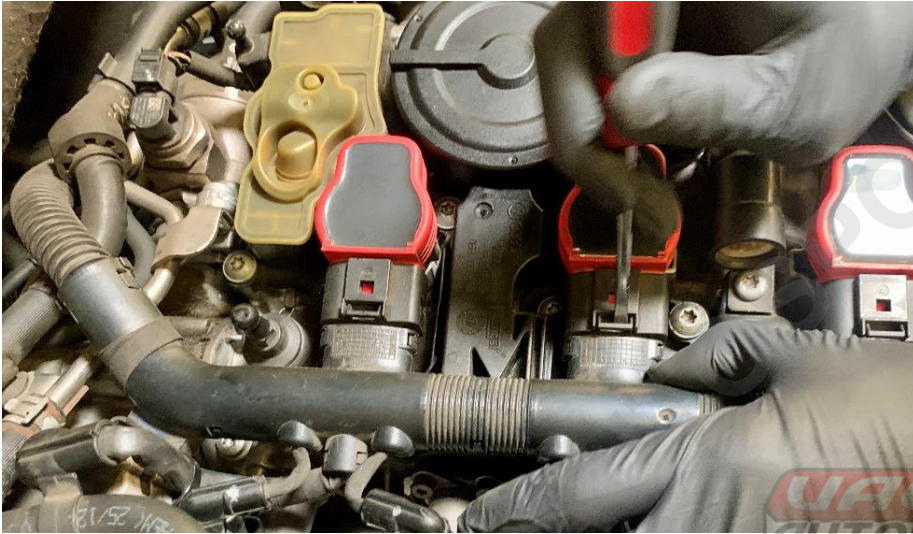
**Step 5**

Use a T30 Torx to remove the bolt securing the harness to the valve cover.

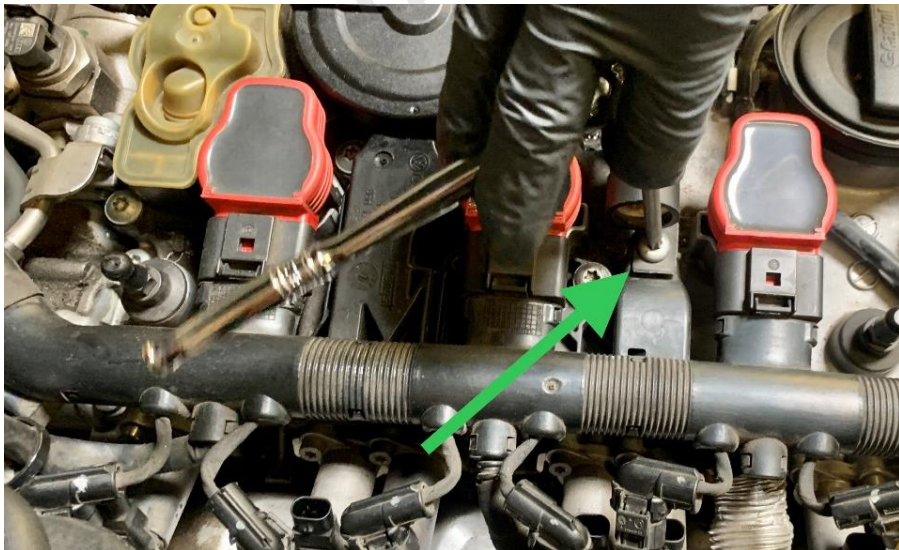
**Step 6**

You can now move the coil harness out of the way to access the PCV plate.

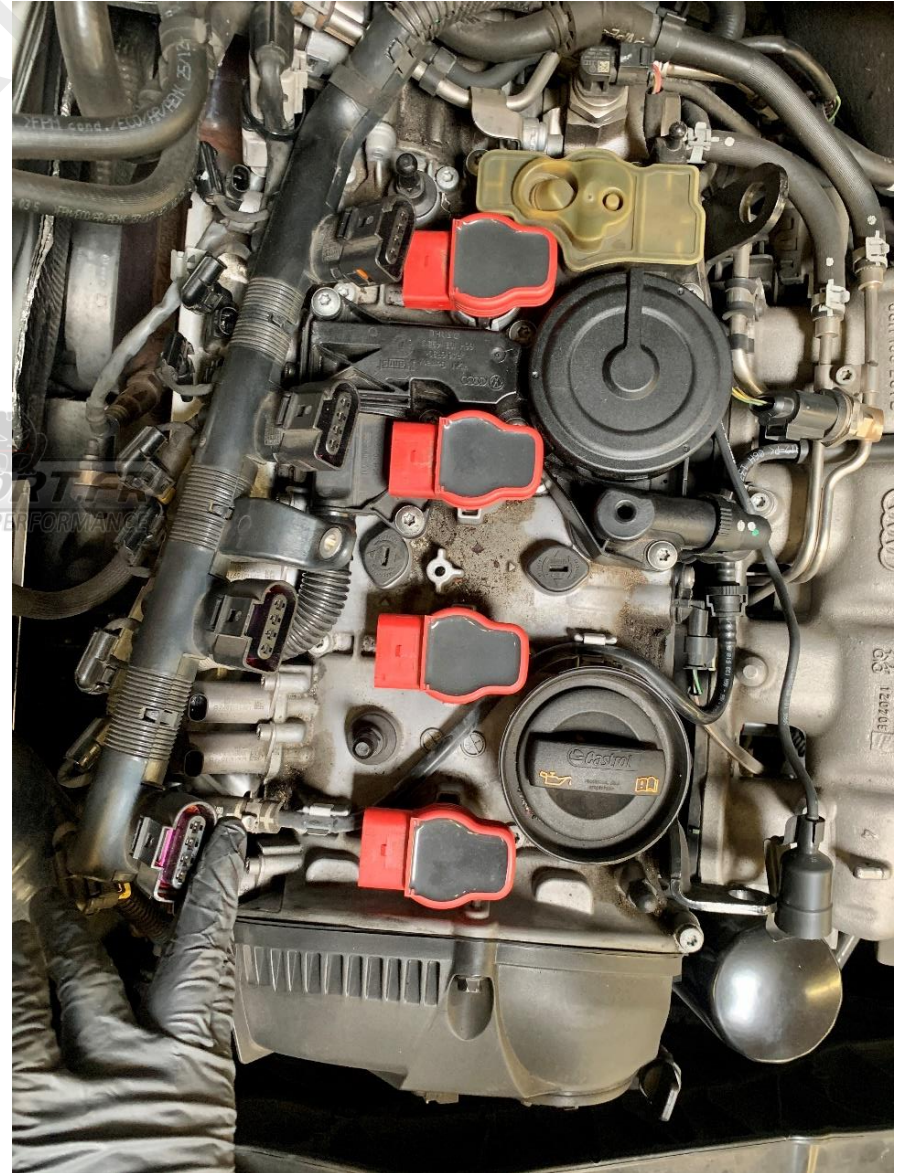

#### Step 7

Remove the 2 rear-most coils near the firewall by pulling upward.

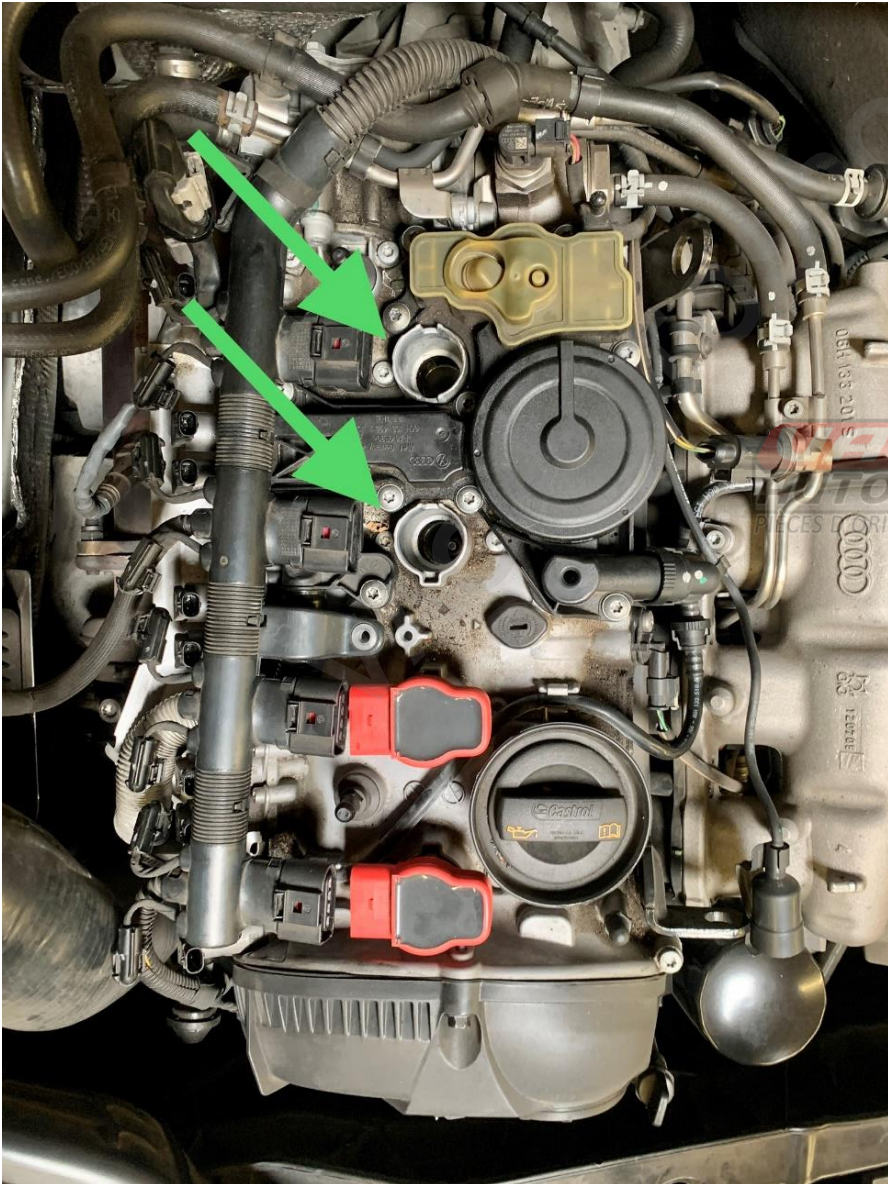

#### Step 8

Using a T30 Torx, remove the hardware from the PCV plate.

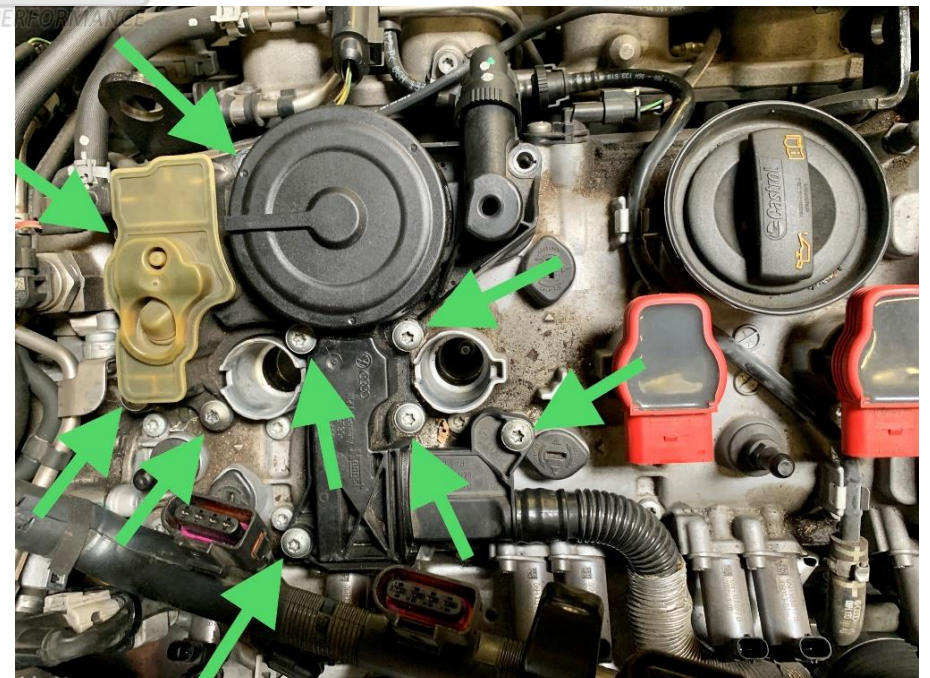

#### Step 9

Unplug the factory breather tube from the PCV plate.



#### Step 10

Carefully remove the PCV plate. Make sure nothing falls into the newly exposed head.

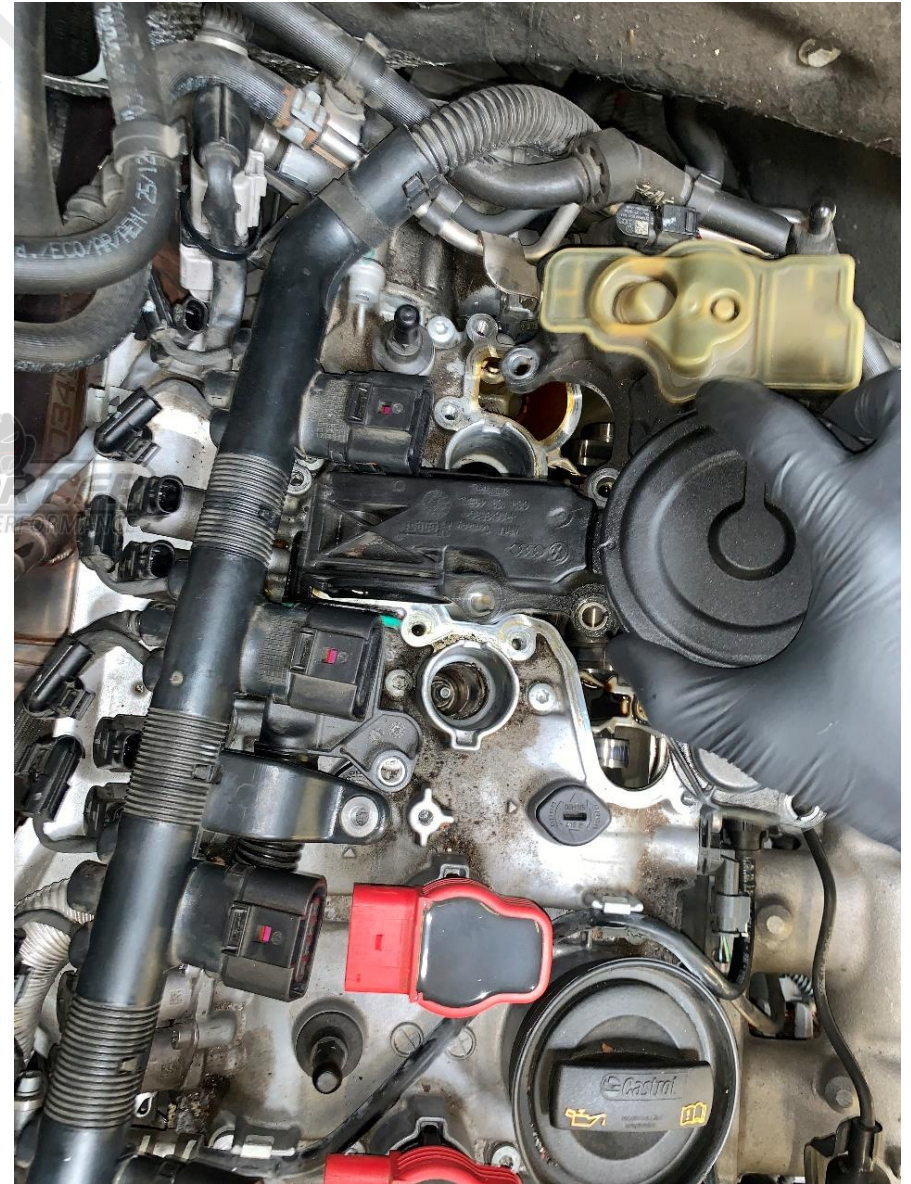

#### Step 11

Swap the gasket from the factory PCV to the 034 Valve Cover Breather Adapter.

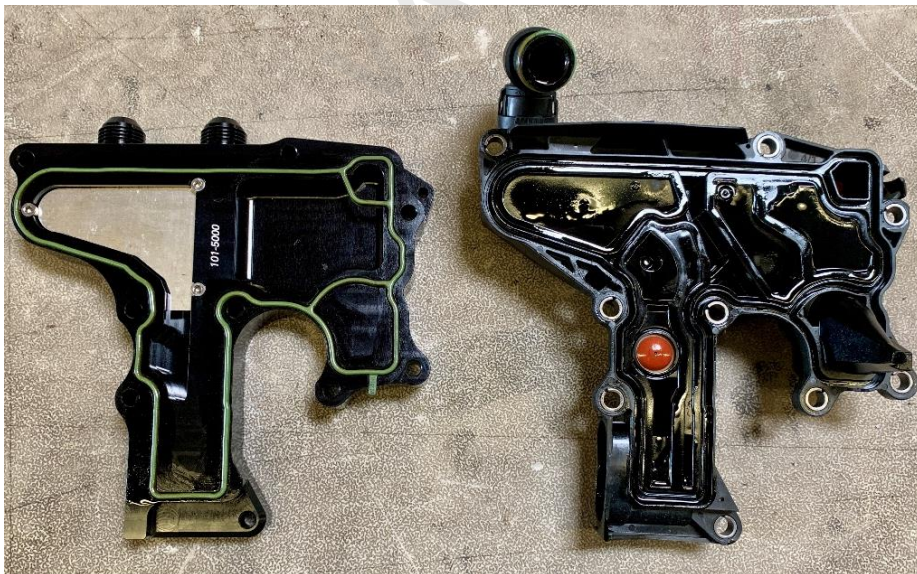

#### Step 12

Use the supplied M6 hardware to mount the Breather Adapter. Torque to **11Nm** in the sequence shown below.

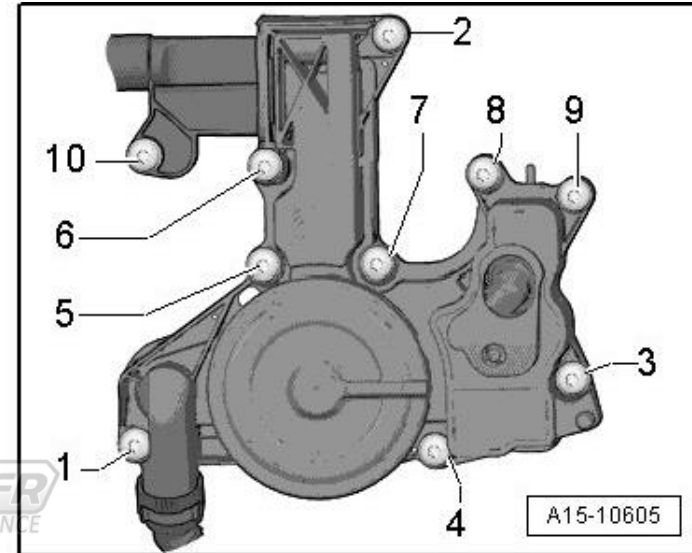

Note that the M6x20 bolt will go where the green arrow is pointing, Number 2 on the sequence sheet.

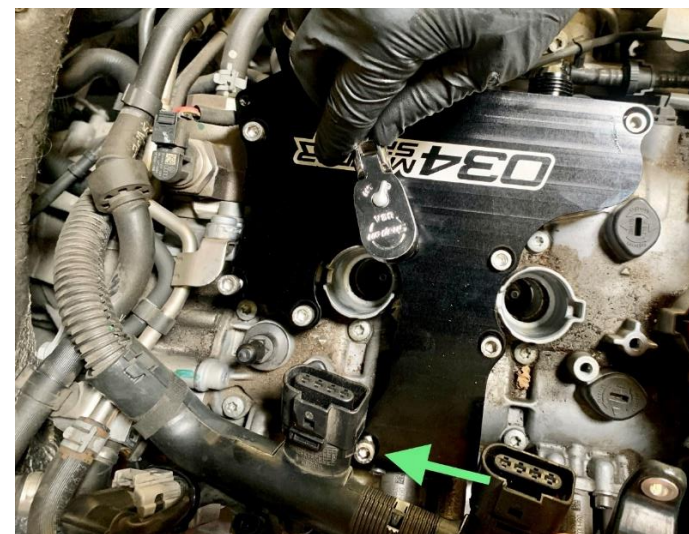

#### Step 13

Plug the factory breather tube into the Breather Adapter and reuse the factory hardware.

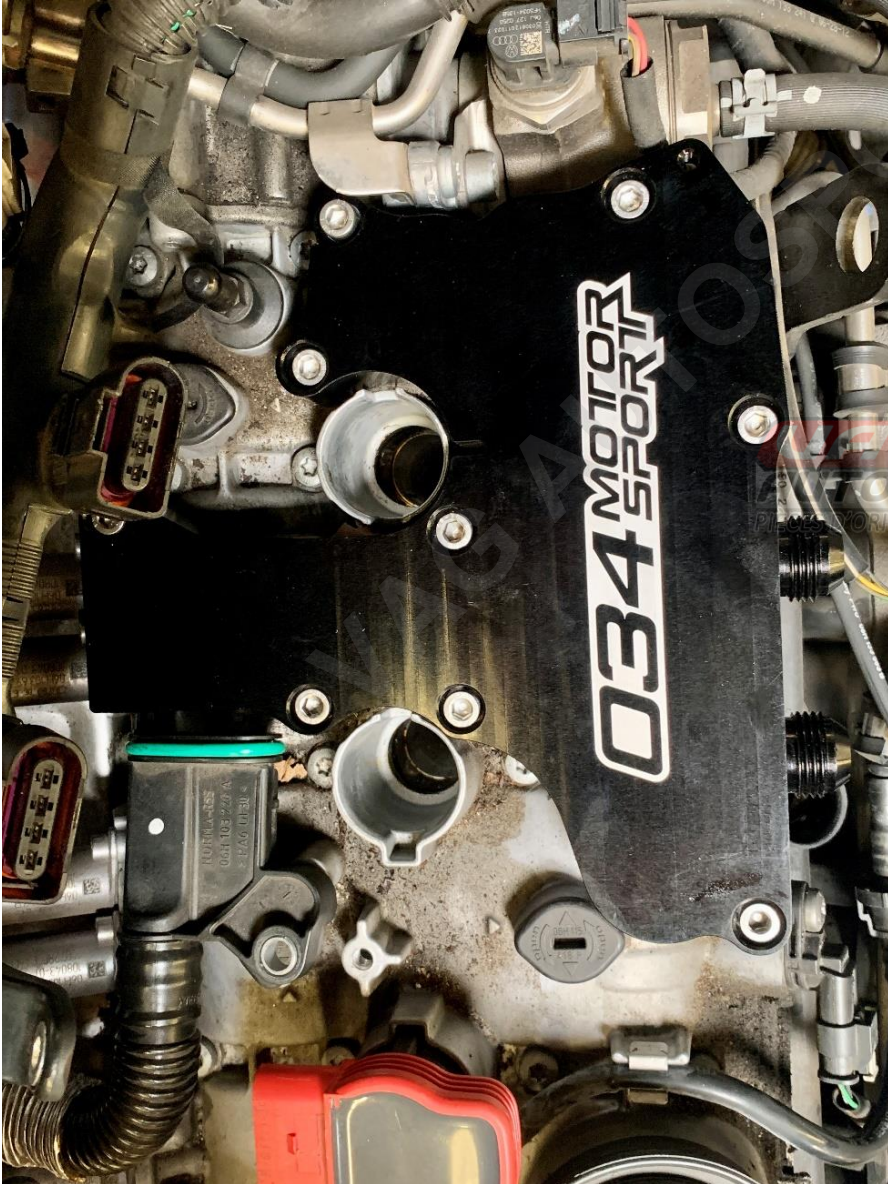

#### Step 14

Use a T30 Torx to remove the factory hose support clamp. Notice that the clamp has a flat side and a rounded side.

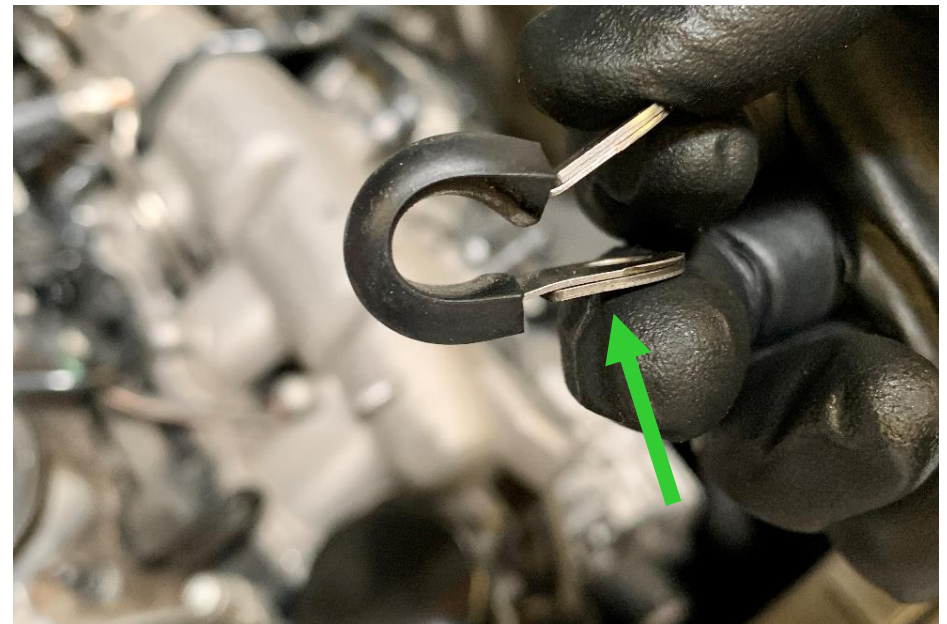

#### Step 15

Use some oil from the oil cap to lubricate the O-ring. Push the intake plug into the opening left from the PCV.

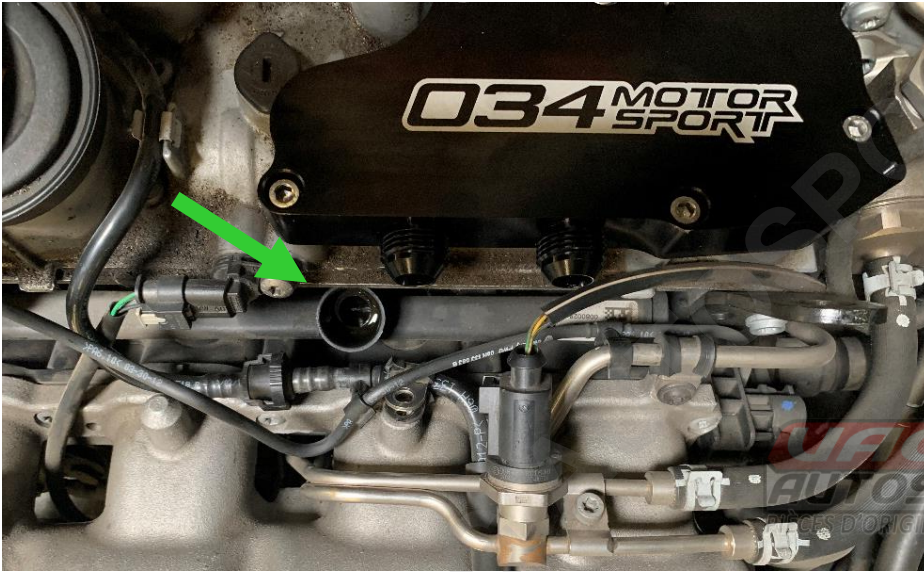

#### Step 16

Turn the plug so that the two locating nubs are parallel with the intake tube.

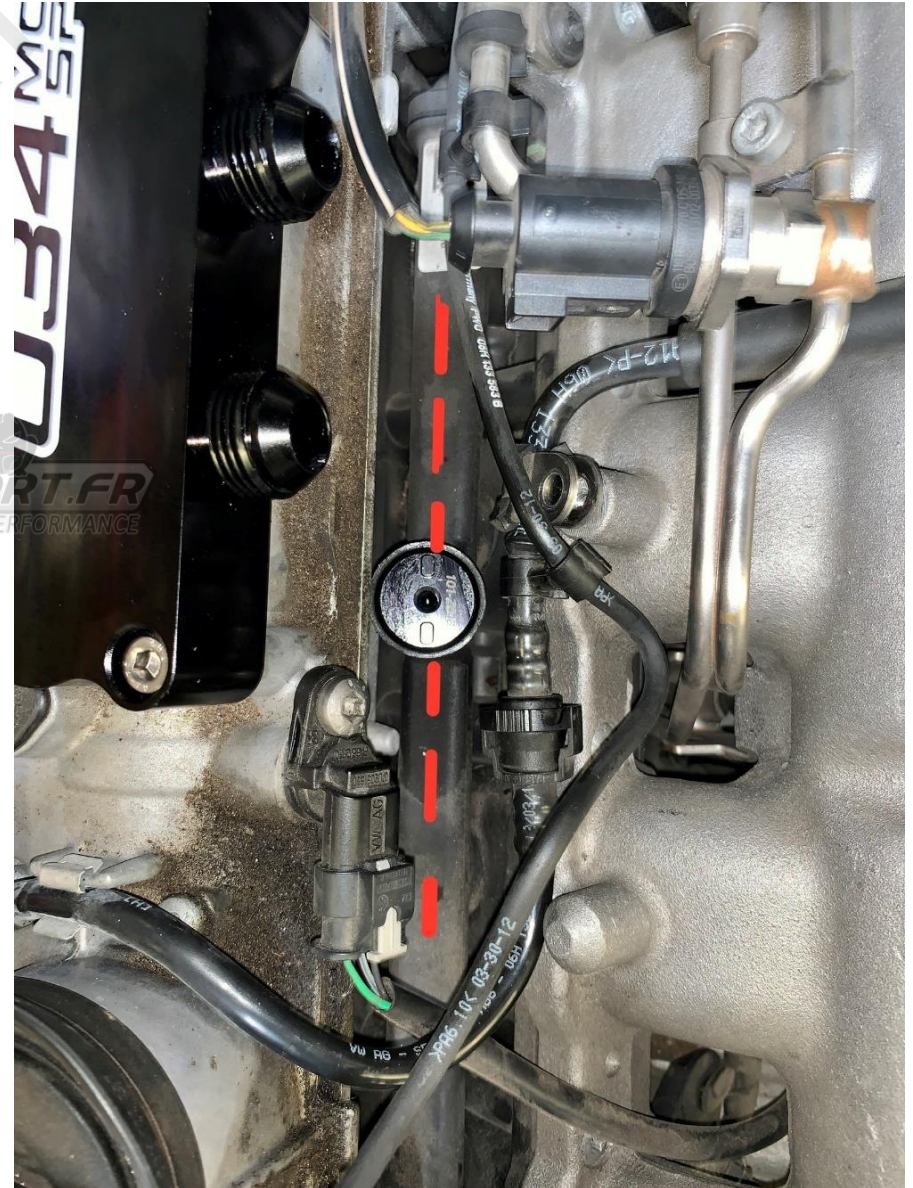

**Step 17**

Place the Intake Plug mounting bracket over the plug, such that the locating nubs fit into the openings on the bracket.  
Secure it with a 4mm Allen bit.

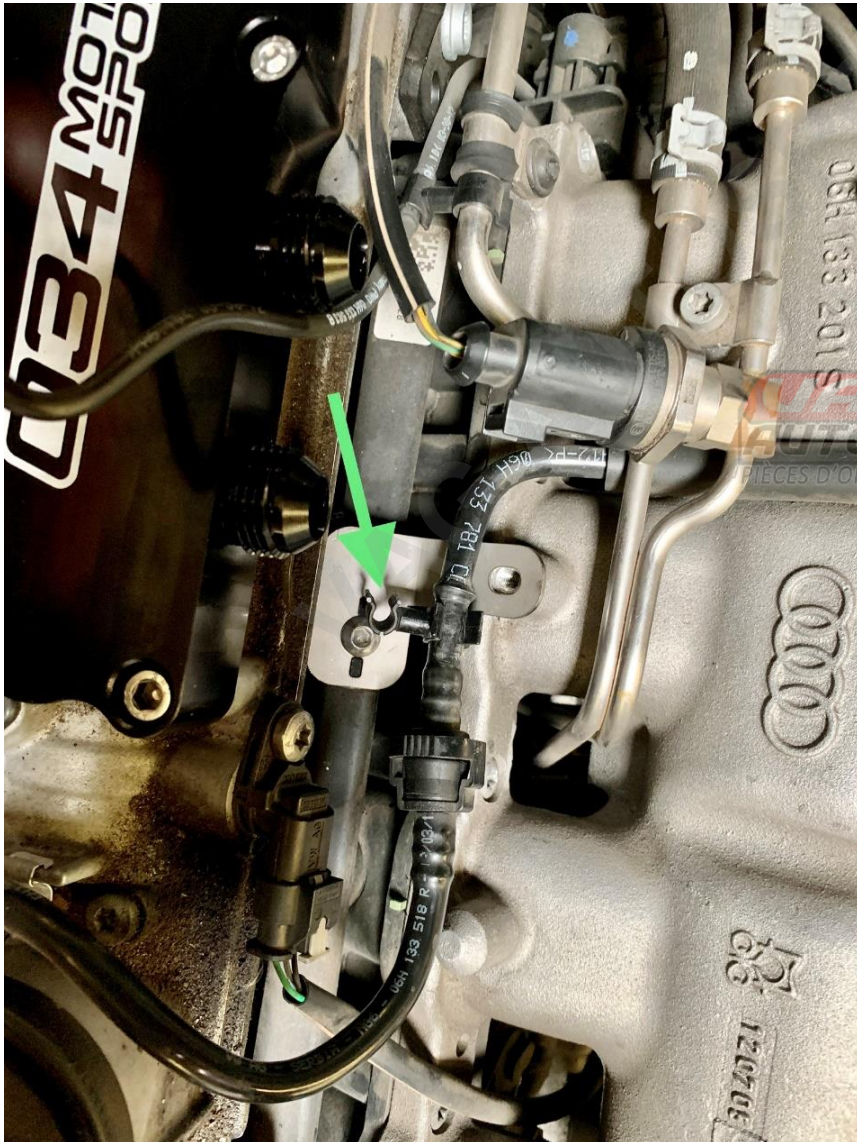
**Step 18**

Stacking order, from bottom up, should be: intake manifold, intake plug bracket, hose support clamp (flat side down), factory bolt.

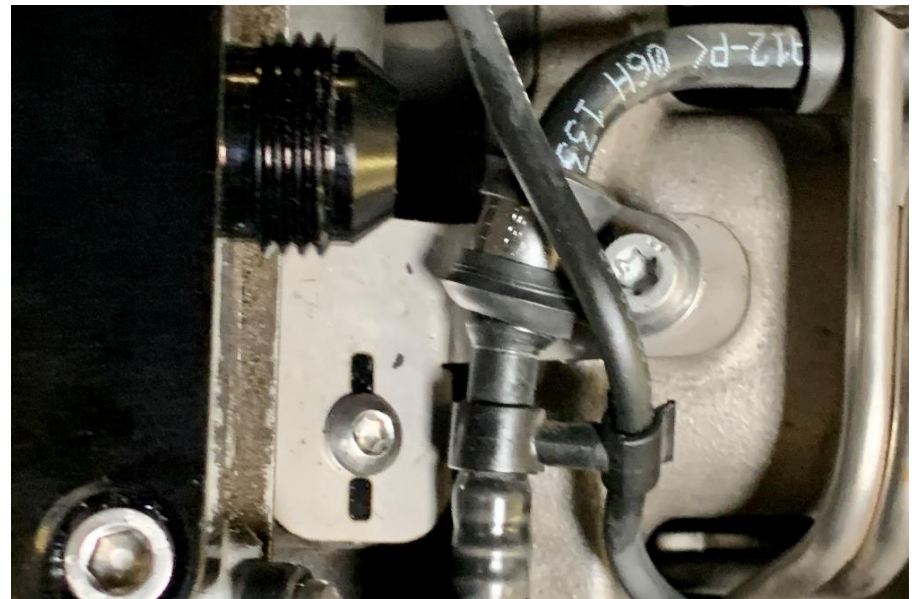

#### Step 19

Push the 2 coils removed in Step 7 back into place.

#### Step 20

Reconnect the coil plugs and reuse the factory hardware to secure the harness.

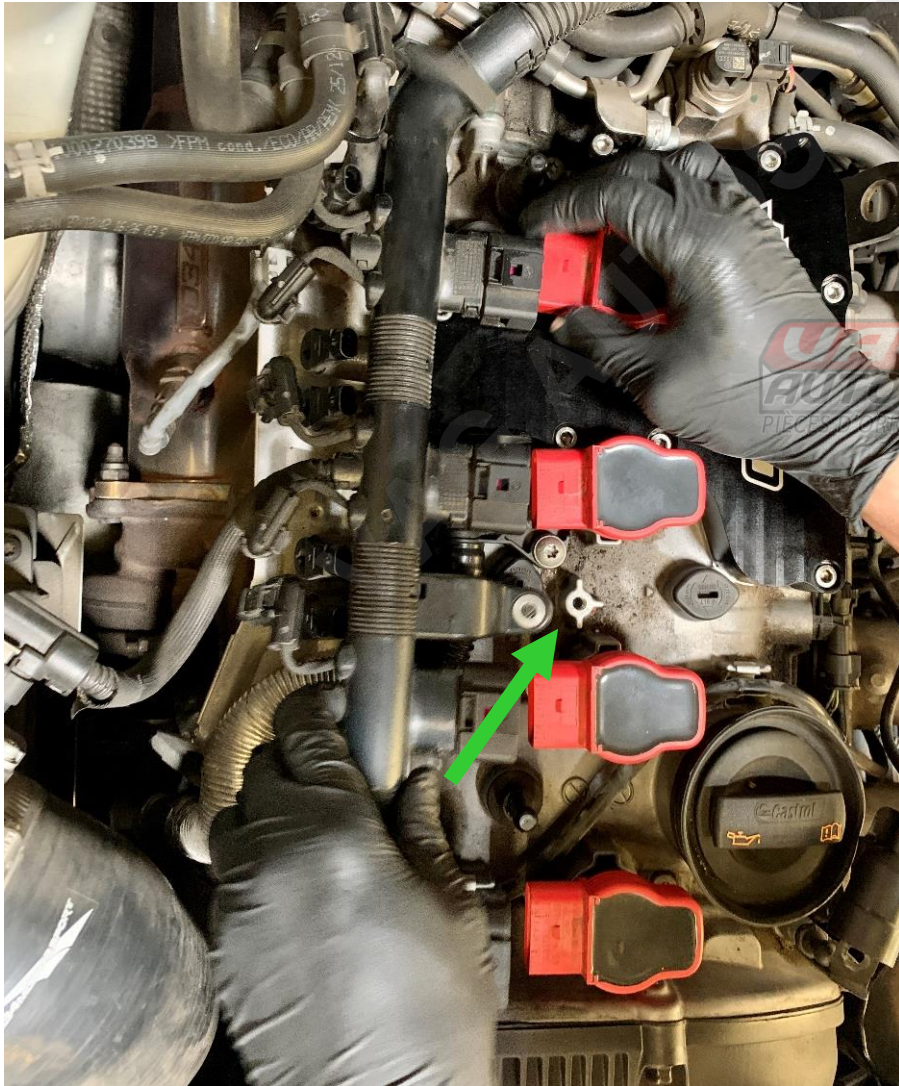

#### Step 21

Reconnect the cam position sensors unplugged in step 3.

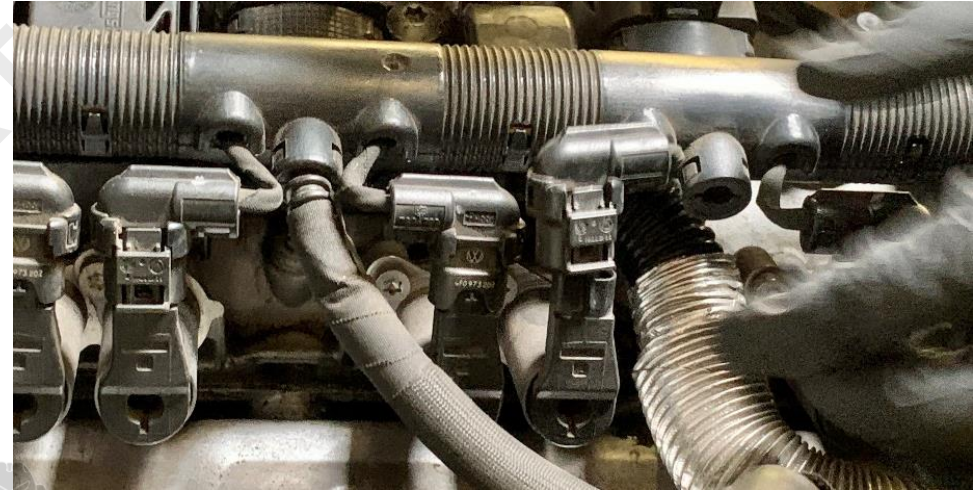

#### Step 22 (Optional)

Using an 8mm wrench, install the engine cover mounting pin into the threaded hole on the Breather Adapter.

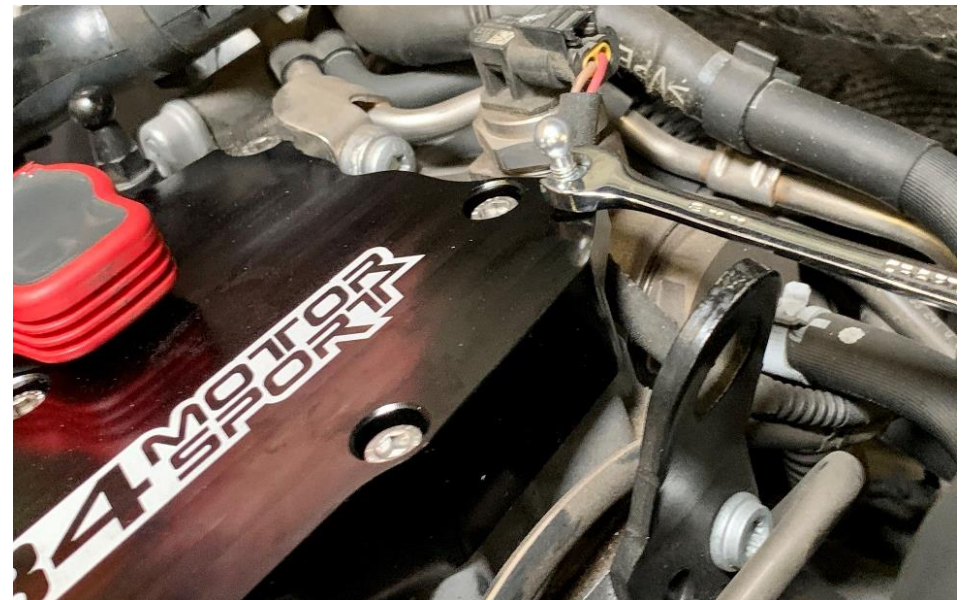

**Step 23**

Using a 5mm Allen, mount the catch can clamp to the lip of the radiator support.

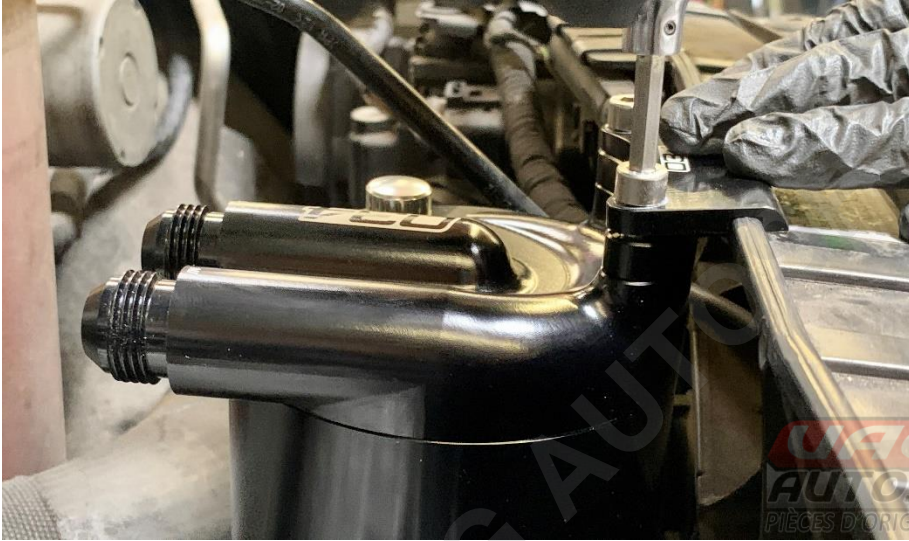
**Step 24**

Using a crescent wrench, thread one end of the -10 hose with the straight fittings to the catch can inlet.

**Step 25**

Attach the other end of the hose to the Breather Adapter as shown in the photo.

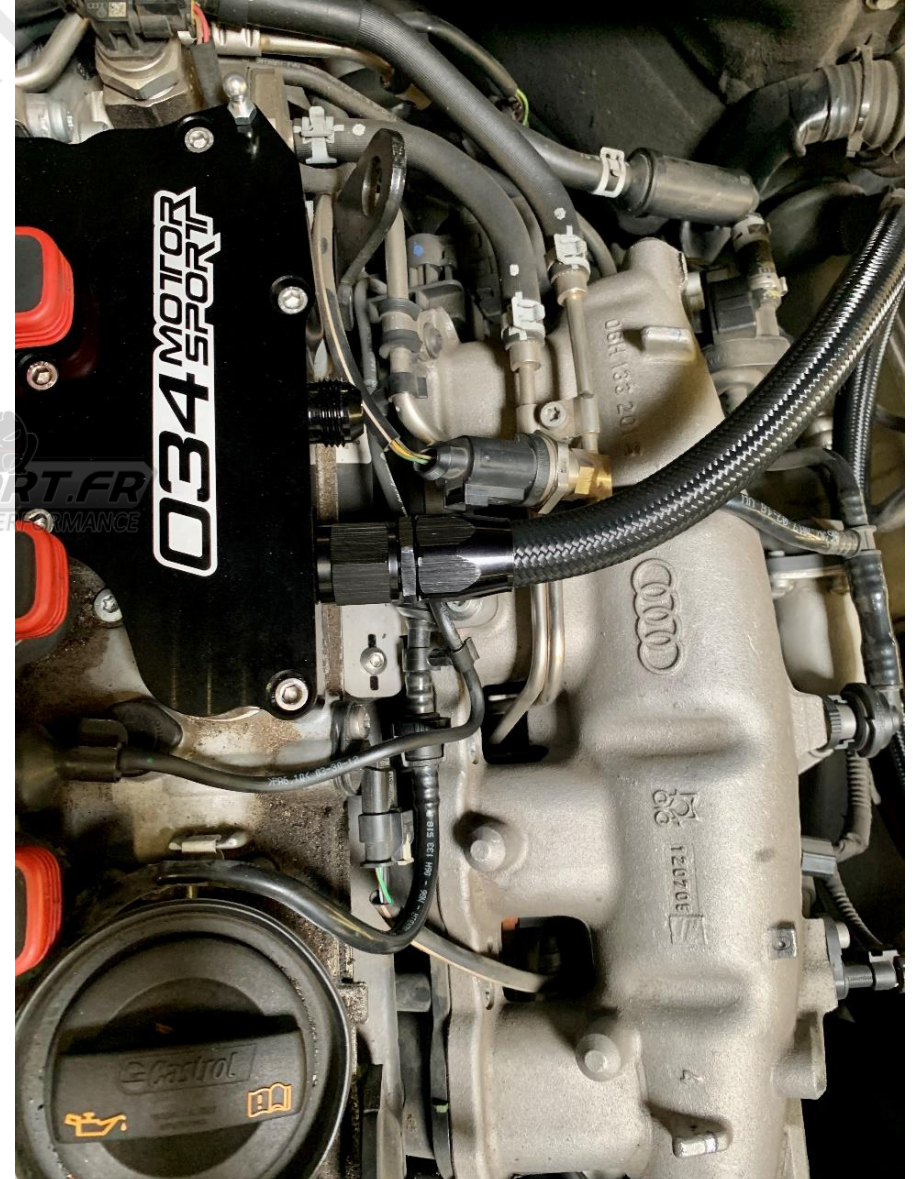

**Step 26**

Thread the second hose in the same manner. The straight fitting will attach to the outlet on the catch can. The 45° fitting will attach to the Breather Adapter.

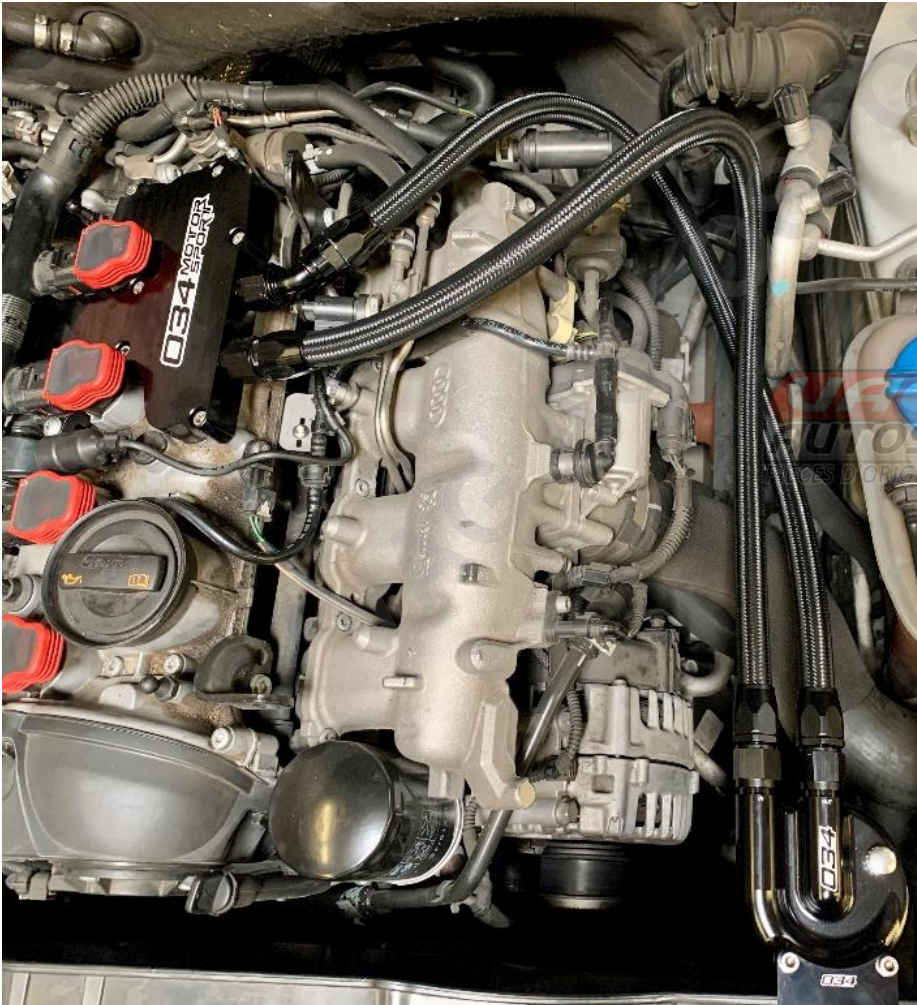

\* Use the zip-tie to clean up any loose wires if needed.

**Step 27**

Use a 5mm Allen to attach the AN hose separators. One near the intake manifold, and the second near the throttle body.

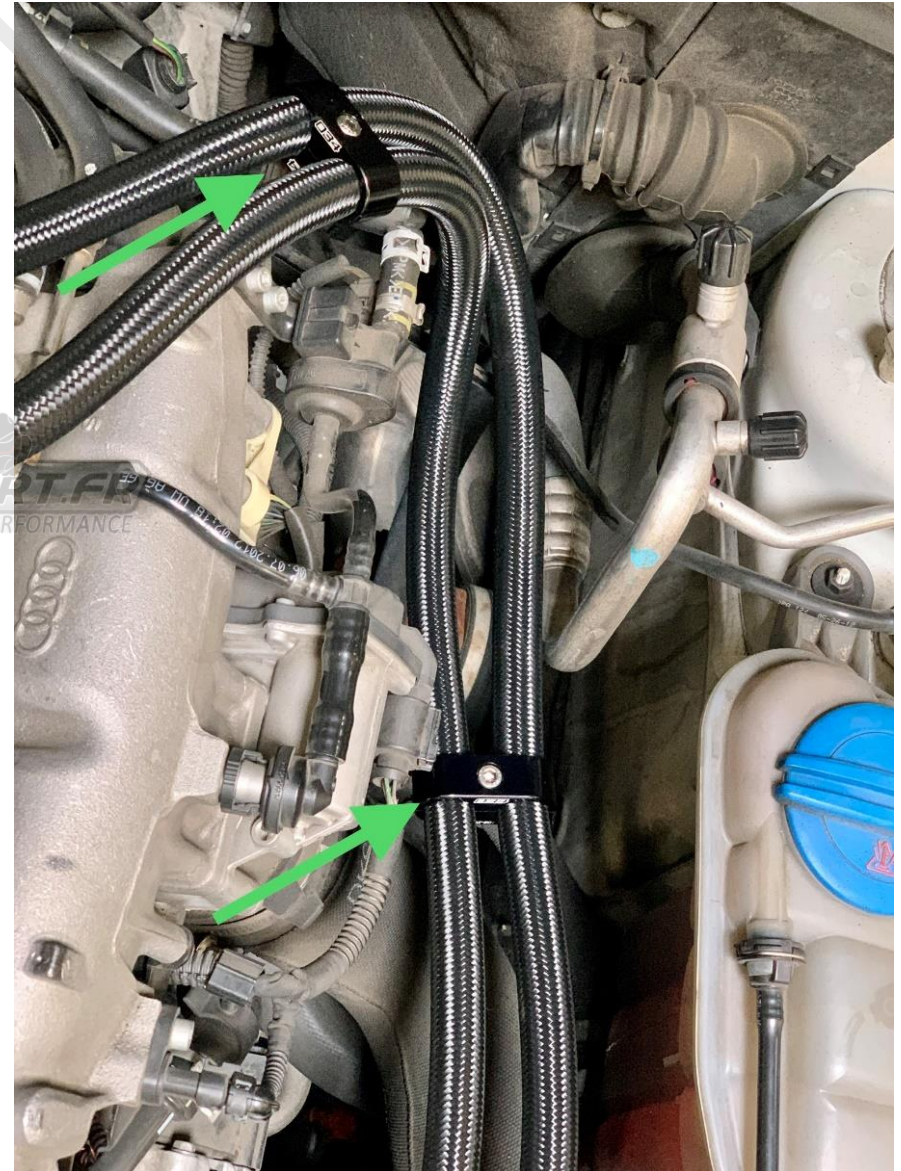

**Step 28**

Push the engine cover back into place, (Preferably after a decent cleaning) and enjoy!

